

**Oil removal filters (DBV - DCV - DAV)**

- ▶ Oil removal filter with coalescing filter element
- ▶ Available in 2 sizes with connections from 3/8" to 1"
- ▶ Particle removal up to 0,01  $\mu\text{m}$
- ▶ Oil residual 0,01 ppm
- ▶ Cartridge clogging level display:
  - green color - ok
  - red color - warning ( $\Delta p > 0,5 \text{ bar}$ )
- ▶ Bowl assembly via bayonet type quick coupling mechanism with safety button
- ▶ Automatic drain mounted as standard
- ▶ Atex certification (II 2GD or II 3GD)

**Note**

In order to ensure the high level of filtration, it is recommended that a 5  $\mu$  filter is installed before the coalescing filter. In order to ensure that any fluid discharged by the auto drain assembly is adequately drained away, it is recommended you use a 6mm fitting and tube.

Technical characteristics			
	Size	Size 3	Size 4
<b>Body and connections type</b>		Technopolymer body, integrated technopolymer connections (T version) Technopolymer body, metal connections (N version)	/
<b>Protection and bowl type</b>		Aluminium body, integrated aluminium connections (P version)	
		Technopolymer protection - PC bowl Technopolymer protection - PA bowl Metal protection - PC bowl Metal protection - PA bowl Metal bowl (blind metal bowl)	
<b>IN / OUT connections</b>	<b>T version</b>	G1/2"	not available
	<b>N version</b>	G3/8" - G1/2" - 1/2" NPT	
	<b>P version</b>	G1/2"	G1"
<b>Assembly configuration</b>		Stand alone	Panel mounted
<b>Assembly positions</b>		Vertical $\pm 5^\circ$	
<b>Filter pore size</b>		Particle removal up to 0,01 $\mu\text{m}$ Oil residual 0,01 ppm	
<b>Bowl capacity</b>		30 cm <sup>3</sup>	90 cm <sup>3</sup>
<b>Condensation drain</b>		Automatic	
<b>Max. fittings torque IN / OUT connections</b>		G3/8" metal: 25 Nm G1/2" metal: 30 Nm G1/2" technopolymer: 22 Nm	G1" metal: 35 Nm

Operational characteristics			
	Size	Size 3	Size 4
<b>Condensation drain</b>		Automatic	
<b>Maximum working pressure</b>		10 bar	
<b>Minimum working pressure</b>		0,5 bar	
<b>Working temperature</b>		-5 °C ... +50 °C	

Weights				
	Size	Size 3 Standard cartridge	Size 3 Oversize cartridge	Size 4
Fully technopolymer version		416 g	634 g	/
Technopolymer body version, aluminium bowl protection and technopolymer bowl		453 g	671 g	/
Technopolymer body version, aluminium bowl		526 g	742 g	/
Aluminium body version, technopolymer protection and bowl		538 g	661 g	1230 g
Aluminium body version, aluminium bowl protection and technopolymer bowl		575 g	698 g	1374 g
Aluminium body version and aluminium bowl		647 g	769 g	1398 g

### Materials

Exploded sectioned

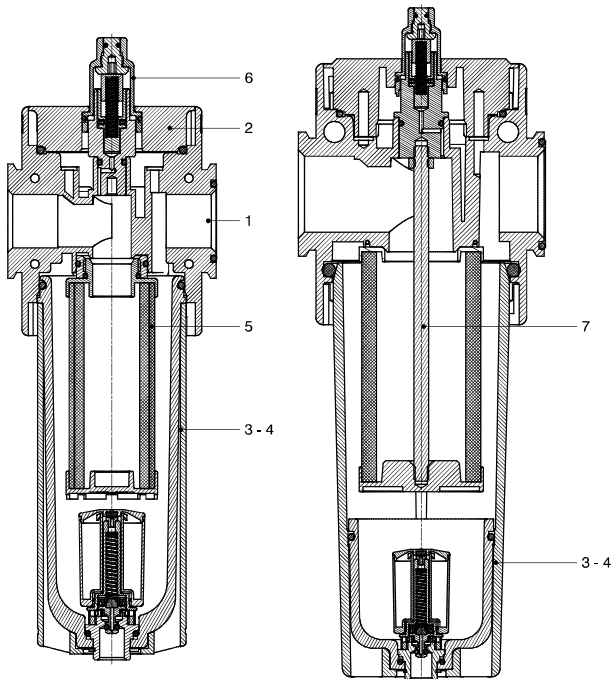

Oil removal filter		
1	Body	Polyamide Die-cast aluminium
2	Upper plug	Polyamide
3	Technopolymer bowl	Polycarbonate Polyamide
4	Metal bowl Bowl protection	Die-cast aluminium Polyamide - Die-cast aluminium
5	Filtering element	/
6	Visual indicator	Polycarbonate
7	Tie rod	Steel (only for size 4)
8	Automatic drain	/

### Design

**Size 3**  
Technopolymer protection

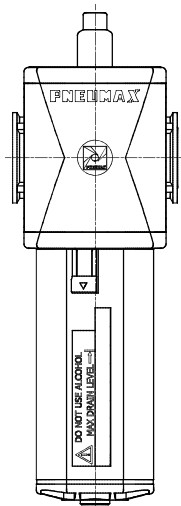

**Size 3**  
Protection / Metal bowl

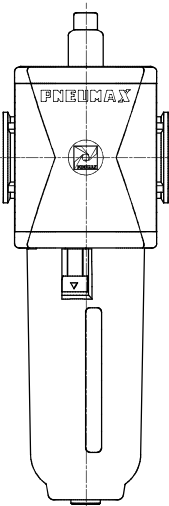

**Size 3 - Oversize cartridge**  
Technopolymer protection

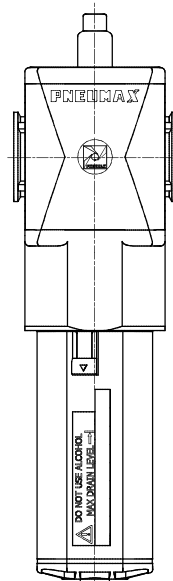

**Size 4**  
All versions

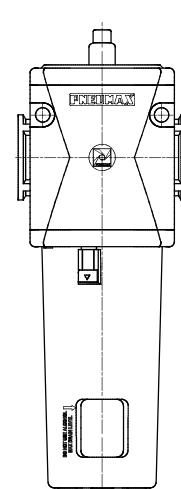

AIR TREATMENT



**Order codes**

T 17 3BDBV T

Version
N : Technopolymer body and metal inserts (not available for size 4)
T : Technopolymer body and thread (not available for size 4)
P : Aluminium body

Size and connections
3ADBV : Size 3 - G3/8" standard cartridge only for N version
3BDBV : Size 3 - G1/2" standard cartridge for all versions
3CDBV : Size 3 - 1/2" NPT standard cartridge only for N version
3BDCV : Size 3 - G1/2" oversize cartridge only for P version
4BDAV : Size 4 - G1" standard cartridge only for P version

Bowl options
: Technopolymer protection - PC bowl
N : Technopolymer protection - PA bowl
P : Metal protection - PC bowl
R : Metal protection - PA bowl
T : Metal bowl

AIR TREATMENT

**Example : T173BDBVT** : Size 3 oil removal filter G1/2", standard cartridge, metal bowl

**Characteristic curves**

Size 3 - Standard cartridge

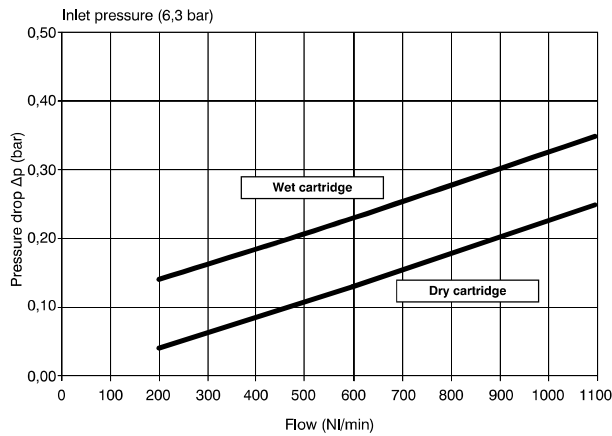
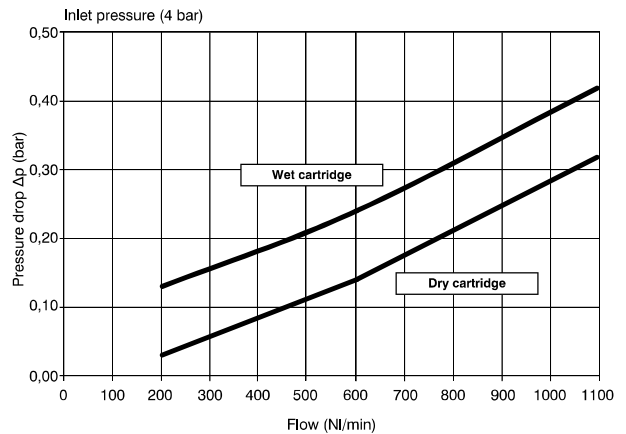
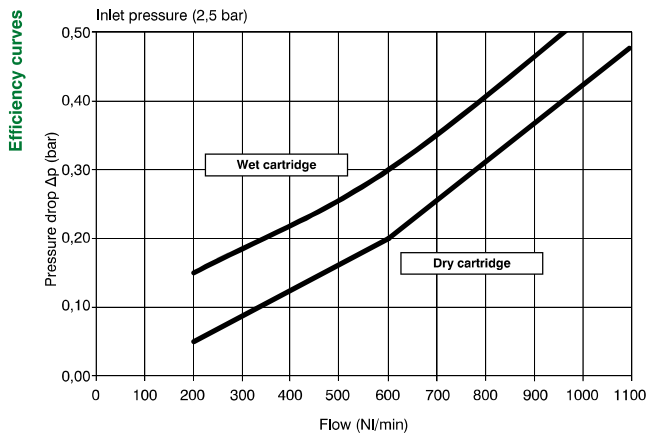

Size 3 - Oversize cartridge

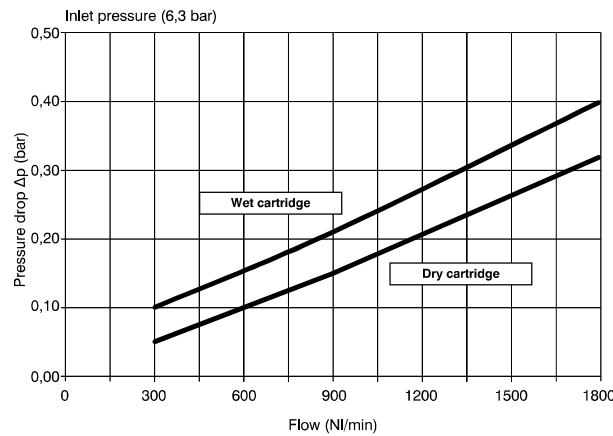
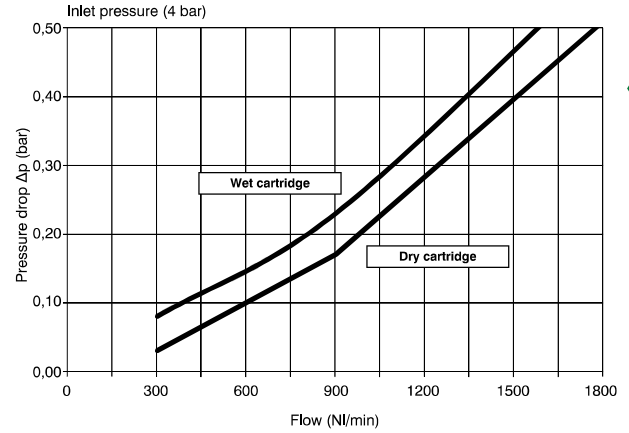
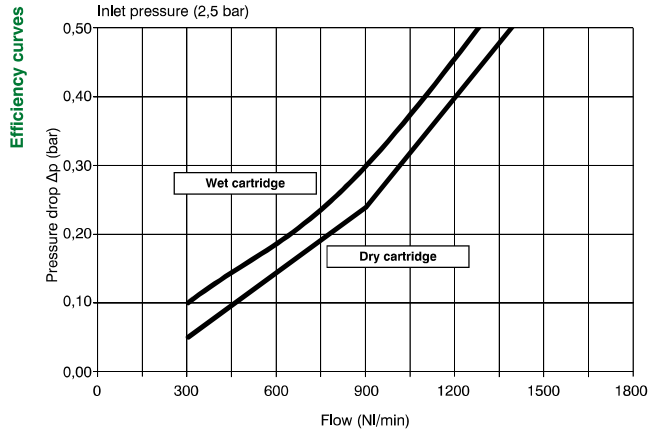

AIR TREATMENT

Size 4 - Standard cartridge

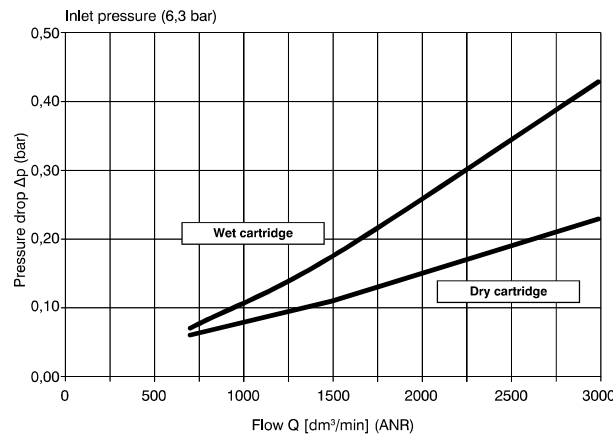
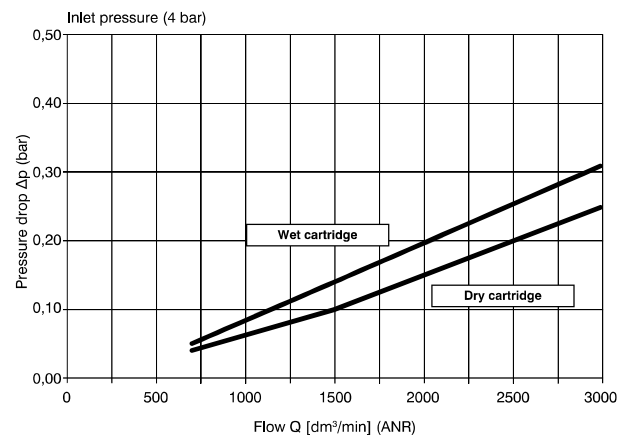
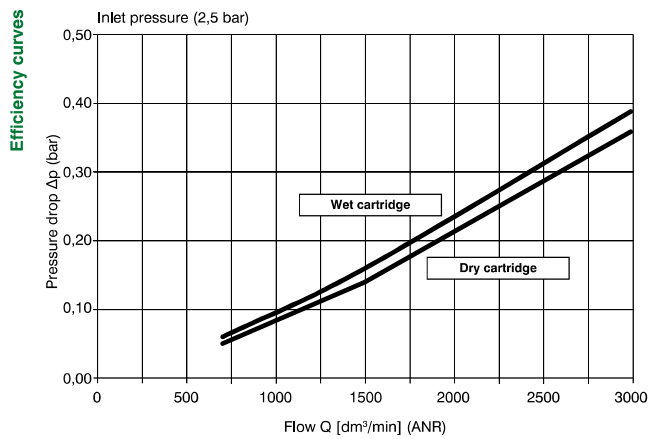

**Dimensions**

AIR TREATMENT

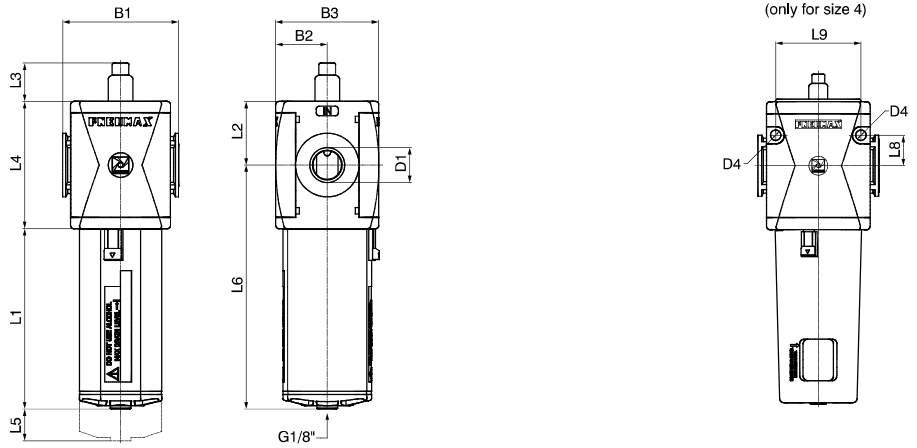

Model	B1	B2	B3	D1		L1 - Bowl material		L3	L4		L5	L8	L9
				Standard cartridge	Oversize cartridge	Technopolymer	Metal		Standard cartridge	Oversize cartridge			
#173..	73	32,5	65	G3/8" G1/2" 1/2" NPT	G1/2"	113,5	116	24,1	80	118	65	/	/
#174..	99	44	88	G1"	/	143	145,5	22,5	105	/	103	25	70