

MAIN FEATURES

Encoder series for direct mounting on motors; integrated elastic coupling allows radial and axial shaft play.

- 3 channel encoder (A / B / Z) up to 10000 ppr
- Power supply up to +28 V DC with several electrical interfaces available
- Up to 500 kHz output frequency
- Cable or connector output
- Available with metal cover for heavy duty applications
- Integrated elastic couplig up to 10 mm bore diameter



ORDERING CODE	ER	53A	M*	500	S	5/28	P	8	X	6	M	R	.162	+XXX
SERIES incremental encoder series EL incremental encoder series ER														
MODEL adjustable flange model 53A adjustable flange model 53B														
METAL COVER * add for metal cover M														
RESOLUTION ppr from 1 to 10000 refer to the available pulses list														
ZERO PULSE without zero pulse S with zero pulse Z														
POWER SUPPLY (with L electrical interface) 5 V DC 5 5 ... 28 V DC 5/28														
ELECTRICAL INTERFACE NPN open collector C push-pull P line driver L power supply 5/28V - output RS-422 RS														
BORE DIAMETER mm 6 mm 8 mm 10														
ENCLOSURE RATING IP 54 X IP 64 S														
MAX ROTATION SPEED (IP 64) 3000 rpm 3 (IP 54) 6000 rpm 6														
OUTPUT TYPE cable (standard length 1,5 m) P preferred cable lengths 2 / 3 / 5 / 10 m, to be added after DIRECTION TYPE (eg. PR5) MIL male connector M JIS-C-5432 male connector J M12 male connector M12 M23 male connector H M16 male connector C														
DIRECTION TYPE axial A radial R														
MATING CONNECTOR mating connector not included .162 to be reported only with connector output (eg. MR.162), for mating connector see Accessories														
VARIANT custom version XXX														

53 A

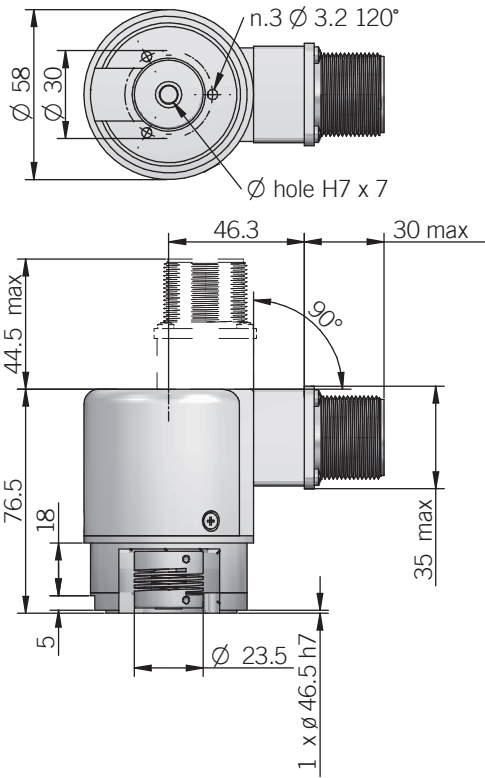

Dimensions with metal cover and axial output

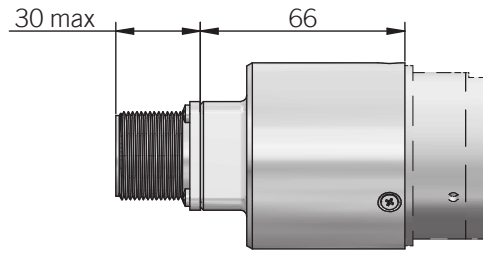

Dimensions with metal cover and radial output

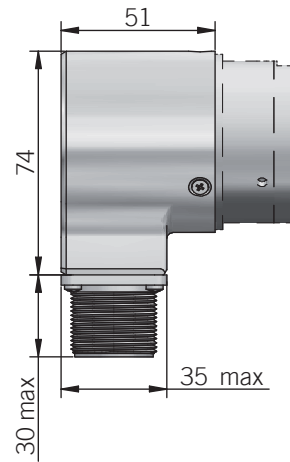

53 B interface

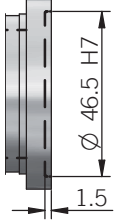

recommended mating shaft tolerance g6
dimensions in mm

ELECTRICAL SPECIFICATIONS

Resolution	from 1 to 10000 ppr
Power supply¹	5 = 4,5 ... 5,5 V DC 5/28 = 4,5 ... 30 V DC (reverse polarity protection)
Power draw without load	800 mW
Max load current	C / P = 50 mA / channel L / RS = 20 mA / channel
Electrical interface²	NPN open collector (AEIC-7273, pull-up max +30 V DC) push-pull / line driver HTL (AEIC-7272) line driver RS-422 (AELT-5000 or similar)
Max output frequency	250 kHz up to 6000 ppr 500 kHz from 7200 ppr
Counting direction	A leads B clockwise (shaft view)
Electromagnetic compatibility	according to 2014/30/EU directive
RoHS	according to 2011/65/EU directive
UL / CSA	certificate n. E212495

EL SERIES RESOLUTIONS

1 - 2 - 4 - 5 - 10 - 15 - 16 - 20 - 25 - 30 - 32 - 40 - 50 - 60 - 70 - 80 - 90 - 160 - 180 - 350 - 450 - 660 - 700 - 750 - 1500

ER SERIES RESOLUTIONS

100 - 120 - 128 - 150 - 200 - 240 - 250 - 256 - 300 - **360** - 400 - 480 - **500** - **512** - **600** - 625 - **720** - 800 - 900 - **1000** - **1024** - 1200 - 1250 - 1440 - 1600 - 1800 - **2000** - **2048** - **2500** - 3000 - **3600** - 4000 - 4096 - **5000** - 6000 - **7200** - 8000 - 8192 - 9000 - **10000**

please directly contact our offices for other pulses, preferred resolutions in bold

CONNECTIONS

Function	Cable C / P	Cable L / RS	7 pin J C / P	7 pin J L / RS no Zero	7 pin M C / P	7 pin M L / RS no Zero	10 pin J L / RS with Zero	10 pin M L / RS with Zero	5 pin M12 C / P	8 pin M12 L / RS	12 pin H	5 pin C C / P	8 pin C L / RS
+V DC	red	red	6	4	F	D	4 - 5	D - E	2	7	12	5	7
0 V	black	black	1	6	A	F	6	F	4	1	10	1	8
A+	green	green	3	1	C	A	1	A	3	6	5	2	1
A-	/	brown or grey	/	3	/	C	7	G	/	5	6	/	2
B+	yellow	yellow	5	2	E	B	2	B	1	4	8	4	3
B-	/	orange	/	5	/	E	8	H	/	3	1	/	4
Z+	blue	blue	4	/	D	/	3	C	5	2	3	3	5
Z-	/	white	/	/	/	/	9	I	/	8	4	/	6
≡	shield	shield	7	7	G	G	10	J	housing	housing	9	/	/

J connector (7 pin)
JIS-C-5432 Size 16
solder side view FV

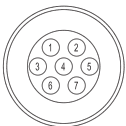

M connector (7 pin)
Amphenol MS3102-E-16-S
solder side view FV

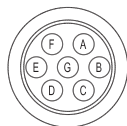

M12 connector (5 pin)
M12 A coded
solder side view FV

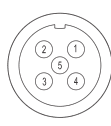

C connector (5 pin)
IEC 60130-9
solder side view FV

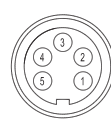

H connector (12 pin) - M23 CCW
Hummel 7.410.000000 -
7.002.912.603
solder side view FV



J connector (10 pin)
JIS-C-5432 Size 16
solder side view FV

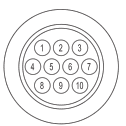

M connector (10 pin)
Amphenol MS3102-E-18-1
solder side view FV

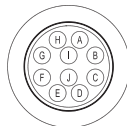

M12 connector (8 pin)
M12 A coded
solder side view FV

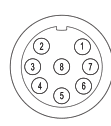

C connector (8 pin)
IEC 60130-9
solder side view FV



MECHANICAL SPECIFICATIONS

Bore diameter	∅ 6 / 8 / 10 mm
Enclosure rating	X = IP 54 (IEC 60529) S = IP 64 (IEC 60529)
Max rotation speed	IP 64 - 3000 rpm IP 54 - 6000 rpm
Shock	50 G, 11 ms (IEC 60068-2-27)
Vibration	10 G, 10 ... 2000 Hz (IEC 60068-2-6)
Moment of inertia	1 x 10 ⁻⁶ kgm ² (24 x 10 ⁻⁶ lbf ²)
Starting torque (at +20°C / +68°F)	< 0,01 Nm (1,42 Ozin)
Bearing stage material	EN-AW 2011 aluminum
Shaft material	1.4305 / AISI 303 stainless steel
Housing material	PA66 glass fiber reinforced / painted aluminum
Bearings	n.2 ball bearings
Bearings life	10 ⁹ revolutions
Operating temperature^{3,4}	-10° ... +60°C (+14° ... +140°F) -25° ... +85°C (-13° ... +185°F) ER series
Storage temperature⁴	-25° ... +70°C (-13° ... +158°F)
Weight	350 g (12,35 oz)

¹ as measured at the transducer without cable influences

² for further details refer to OUTPUT LEVELS on TECHNICAL BASICS section

³ measured on the transducer flange

⁴ condensation not allowed