

CATALOG

Photoelectric Sensors

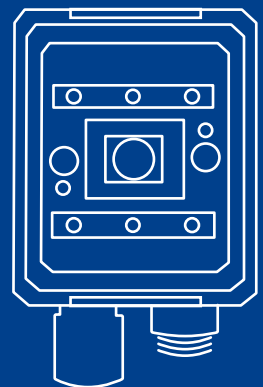
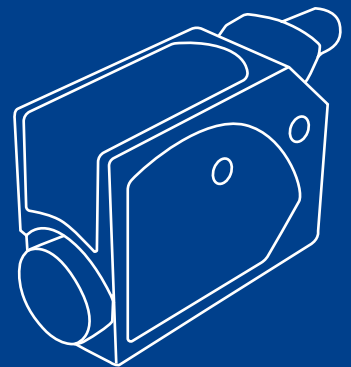
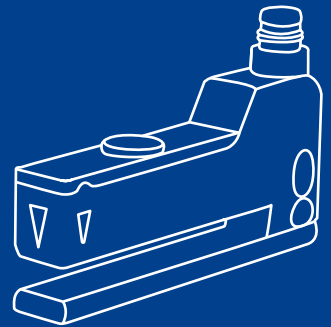

PHOTOELECTRIC SENSORS

Tubular, Miniature and Fiber Optic sensors for object detection in reduced space



IO-Link



IO-Link



IO-Link

Fork sensors for label detection



Contrast and Luminescence sensors for registration marks detection

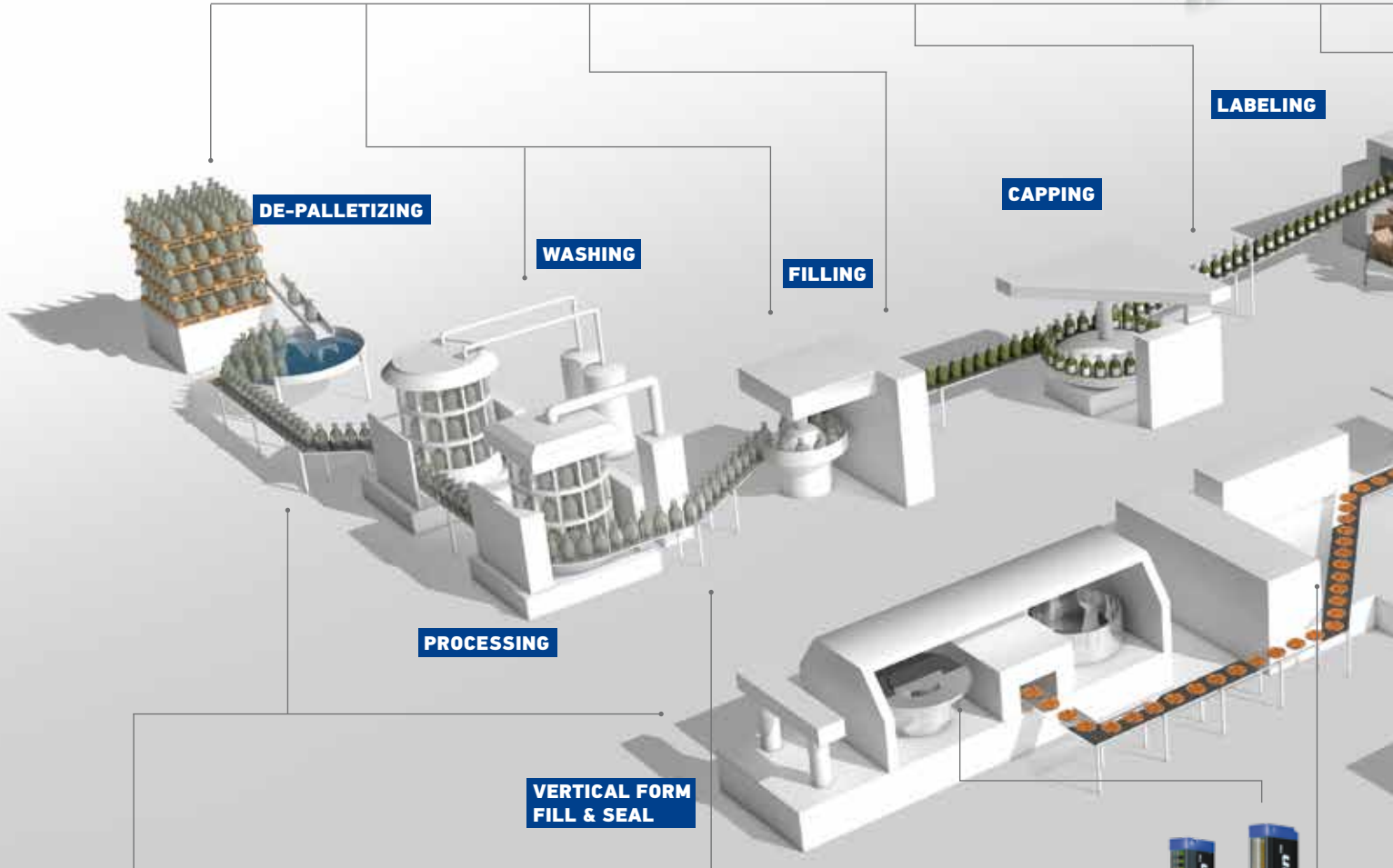

Extended range of universal compact sensors for object detection



Smart-VS: The Smart Vision Sensor can detect the presence/absence and orientation of various format objects

Dimensional sensors for height/width measurement and object positioning



Applications

- De-Palletizing
- Washing
- Filling
- Capping
- Labeling
- Case Packing
- Stretch-wrapping
- Palletizing
- Storage & Retrieval
- Cartoning
- Wrapping
- Vertical Form Fill & Seal
- Processing

Datalogic has more than 40 years of experience in the sensors and safety sector, developing their first product, a **Photoelectric Sensor**, in 1972. Today, Datalogic is one of the largest manufacturers of sensor and safety products worldwide.

Datalogic is the market leader in Italy for photoelectric sensors and safety light curtains, ranking among the **top-10 manufacturers** in Europe by market share.

Datalogic's **Sensors and Safety** portfolio solves customer applications in **Factory Automation**, specializing in Processing and Packaging machinery, and Automated Material Handling Systems related to manufacturing industries such as Automotive, Electronics, Pharmaceutical, Food & Beverage, Paper and Printing, Wood-working, Ceramics, Glass, and Textiles.

Area sensors for the detection of objects with different shape and dimensions



Maxi and Compact sensors for object detection



IO-Link

STRETCH-WRAPPING

PALLETIZING

CASE PACKING

STORAGE & RETRIEVAL

WRAPPING

CARTONING



TOF distance sensors for measurement and object positioning



IO-Link

Background suppression sensor with Infrared LED Emission TOF technology to detect objects with irregular surface and different colors avoiding surface reflections. The S65-M is very suitable for level detection in sorting applications for food, logistic and postal industries

PHOTOELECTRIC SENSORS PRODUCTS RANGE

UNIVERSAL FUNCTION	M18 TUBULAR	FIBER OPTIC	MINI SIZE	MIDI SIZE	MAXI SIZE	
	APPLICATION SPECIFIC FUNCTION					
	FORK	CONTRAST/COLOR	LUMINESCENCE	AREA/DIMENSION	DISTANCE	SMART VISION

INDEX

Photoelectric sensors	6
Selection chart	12
Reference guide	16
Miniature sensors	18
Tubular sensors	46
Midi sensors	62
Fiber optic sensors	70
Compact sensors	92
Maxi sensors	100
Area sensors	112
Dimension light sensors	116
Distance sensors	124
Fork sensors	140
Contrast sensors	148
Luminescence sensors	154
Vision sensors	158
Accessories	166
Complementary sensors	180



PHOTOELECTRIC SENSORS

PHOTOELECTRIC SENSORS

THROUGH BEAM

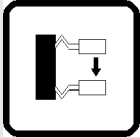
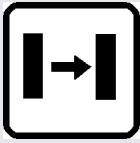

The light emitter and receiver are contained in two different housings and installed facing each other. The light beam released by the emitter directly hits the receiver; every object interrupting the beam is therefore detected. This system is used to obtain significant signal differences (when the light directly hits the receiver and when the object interrupts the beam) with the highest Excess Gain and the largest operating distance (up to 60 m). Moreover, these sensors can operate in the harshest working conditions, such as dirty or dusty environments. The through beam optic function typically operates in the dark mode: the output is activated when the object interrupts the light beam between emitter and receiver.

RETROREFLECTIVE

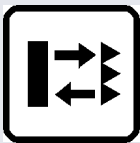

Both emitter and receiver are located inside the same housing for retro-reflective photoelectric sensors. Utilizing a prismatic reflector, the emitted light beam is reflected onto the receiver, detecting the object when it interrupts the light beam.

POLARIZED RETROREFLECTIVE

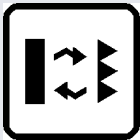

In polarized retroreflective sensors, the emitted light is polarized on a vertical plane through a polarization filter. The prismatic reflector rotates the light plane by 90°. A polarization filter placed on the receiver selects only the horizontal plane reflected by the prismatic reflector, ignoring the light reflected by other light sources. This technique guarantees a reliable signal reception, reaching significant distances-

RETROREFLECTIVE FOR TRANSPARENT

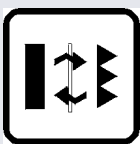

For the detection of transparent objects, such as PET bottles or Mylar sheets, a low-hysteresis polarized retroreflective model (which detects small signal differences) can be used.

These sensors elaborate the slight signal differences received when the light beam passes through a transparent object, avoiding false detections due to the nature of this kind of targets.

This technique mostly suits applications for the detection of objects positioned at considerable distances, where a prismatic reflector can be installed.

Typically, the operating distance proportionally increases with the reflector's dimensions.

DIFFUSE PROXIMITY

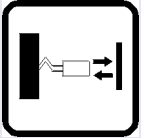

In photoelectric sensors with this optic function, both emitter and receiver are placed inside the same housing. These sensors work with weaker signals because the emitted light beam is reflected to the receiver by the object. As a consequence, the excess gain and the operating distance are reduced. However objects are detected without a prismatic reflector, making installations quick and easy.

FIXED FOCUS PROXIMITY

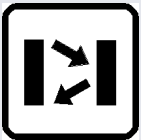

Fixed focus proximity sensors have a simple fixed background suppression distance, beyond which no objects are detected. The fixed triangulation of the optics greatly reduces the detection distance of reflective objects. The visible red emission simplifies the sensor's installation.

BACKGROUND SUPPRESSION

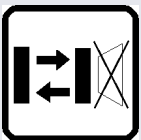

Background suppression sensors detect objects while avoiding reflections from the background. When the sensor is used for the first time, the proper background suppression distance has to be set through a distance adjustment trimmer. Once the background has been acquired, the objects can be detected regardless of their color. Background suppression sensors are not very reliable with highly clear, transparent or shiny objects.

BACKGROUND SUPPRESSION

FOR CLEAR DETECTION

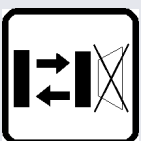

Background suppression technology often has difficulty to detect reliably transparent, clear, or shiny objects. These objects generate false detections due to their highly reflective surfaces. Datalogic's patented background suppression technology guarantees reliable and repeatable detection, avoiding false detections. These models are available with LED emission, ideal for reflections caused by moving surfaces such as conveyor belts, or with LASER emission for the detection of small objects on fixed or highly reflective backgrounds. These sensors can substitute a short distance polarized retroreflective sensor for transparent objects, since they do not require a prismatic reflector.

PHOTOELECTRIC SENSORS

CONTRAST



Contrast sensors distinguish the received light beams on the basis of their degrees of intensity, which depend on the color or material of the detected surfaces. A typical application of these sensors is the detection of colored registration marks used in packaging machines to synchronize the folding, cutting and welding phases. In presence of colored surfaces, the contrast is highlighted using a LED with colored light emission, typically a selectable red, green or blue LED. The white light emission allows to detect very slight contrasts in similar materials and colors.

COLOR



The color of an object is identified according to the different reflection coefficients obtained with the red (R), green (G) and blue (B) light emissions. For instance, yellow is characterized by R=50% G=50% B=0% reflections, orange by R=75% G=25% B=0%, pink by R=50% G=0% B=0%, the combinations are infinite. Color sensors cover a wide variety of applications, ranging from quality and process controls to automatic material handling for the identification, orientation, and selection of objects according to their color.

LUMINESCENCE



Luminescence sensors emit invisible ultraviolet light, which is reflected at a higher wavelength (minor energy) on the fluorescent and phosphorescent surface, shifting into the visible light spectrum.

The ultraviolet emission is modulated and the visible light reception is synchronized. The maximum immunity against external interferences, like reflections caused by very shiny surfaces, is obtained and fluorescent targets, invisible to the human eye, can be detected. Luminescence sensors are used in several industrial fields to detect items containing phosphorous such as labels on glass or mirrors, fluorescent marks marked on tiles, fluorescent glues on paper, cutting and sewing guides, as well as fluorescent paints or lubricants.

FORK

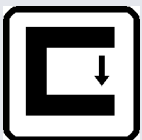

A fork sensor, is based on a particular model of the through beam sensor, where emitter and receiver are placed opposite to each other on the internal sides of an "U-shaped" housing. Any target passing through the internal slot interrupts the beam and is detected. The most typical fork sensor applications are hole/teeth detection on wheels, label detection on thin supports, and control of edge and continuity of sheets of labels or tapes. The emission is generally infrared or red light in order to detect colored registration marks on translucent films.

DISTANCE

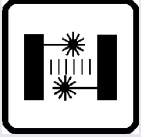

Datalogic distance sensors are based on Time of Flight (T.O.F.): the distance is calculated on the basis of the time between the moment the LASER pulse is generated and the moment the emitted light is reflected off the object, back to the sensor. These sensors are generally used to measure an object's distance within a selected range, while the output is linearly scaled to the analog signal. This technology provides high precision and fast measurements in many applications, such as automatic warehousing (to drive industrial vehicles and avoid collisions), packaging and material handling.

DIMENSION

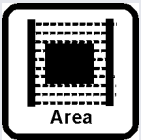

Area and Dimension light grids utilize several light beams for area or dimensional measurements of objects. An object's area and size are measured using parallel cross-beams, which identify obscured beams, providing accurate information to a host GUI or PC. Models of light grids vary by length to match each application requirements.

SMART VISION SENSOR



The Datalogic Smart Vision Sensor offers improved detection features with an easy setting procedure, without the need of specific machine vision skills. The application field addressed can vary from automotive for parts checking to food, beverage and cosmetic packaging, such as bottling with specific tools for: label presence; label printing, cap presence and orientation.



SELECTION CHART

UNIVERSAL PHOTOELECTRIC SENSORS

	MINIATURE				TUBULAR	MIDI
SECTION	S1N	S2N	S3N	S4N	S5N	S6N
PRODUCT LINE	SMall 	S100  IO-Link	S3Z 	S45 	S5N  IO-Link	S62 
OPERATING RANGE						
Through beam 	0...2 m	0...12 m	0...15 m 0...30 m 	0...15 m 0...20 m 	0...30 m 0...60 m 	0...25 m
Retroreflective 	0,05...1,5 m	0,01...8 m			0,1...5 m	0,1...13 m
Polarized retroreflective 	0,1...1 m	0,01...3 m 0,01...5,5 m	0,05...4 m 0,3...10 m 	0,1...7 m 0...2 m (coaxial) 0,1...15 m 	0,1...4,5 m 0,1...16 m 	0,1...8 m 0,3...20 m 
Retroreflective for transparent 			0...2 m	0...2 m	0,1...1,7 m	
Diffuse proximity 		2...300 mm 2...500 mm	5...150 mm 0...700 mm	0...800 mm 1...250 mm 	0...100 mm 0...400 mm 0...700 mm 0...350 mm 	0...900 mm 0...2000 mm 0...900 mm 
Fixed focus 	3...15 mm 3...20 mm 3...30 mm 3...50 mm	70 mm			100 mm	
Background suppression 		0...100 mm	0...300 mm 0...300 mm 	1...200 mm 3...400 mm 4...120 mm 	0...150 mm 0...100 mm	30...300 mm 60...600 mm 60...1200 mm 200...2000 mm 30...1500 mm 50...350 mm 
Fiber optic 					0...100 mm (through beam) 0...30 mm (diffuse proximity)	
Contrast/Color 				10 ±2 mm	10 ±2 mm	
Luminescence 					0...20 mm	
Page	18	22	32	38	46	62

(*) The maximum operating distance is determined by the optic fiber and accessory lens used and the response speed selected in the specific model

The table shows the maximum operating distance reached by different sensors models. Some measures indicate only the highest performances obtained by the corresponding sensor. Other operating distance values might be available for the same series and some optic functions might be carried out through LED or LASER emission, reaching different distances. For more specific information refer to the dedicated product page in this guide or download datasheets and manuals from our website (www.datalogic.com)

FIBER OPTIC				COMPACT				MAXI			
S7N		S8N		S9N		S10N					
S70		S8		S300 PA		S300 PR					
											
IO-Link		IO-Link									
0...1740 mm (*)		0...25 m		0...50 m		0...60 m					
				0,1...15 m							
		0...5 m		0,1...10 m		0,1...22 m					
		0...10 m 									
		0...0,8 m									
		0...2 m									
0...550 mm (*)		0...500 mm		50...2000 m		0...5000 mm					
		50...300 mm		0,2...2 m		400...2500 mm					
		20...200 mm 									
		9 ±2 mm									
		10...20 mm									
70		92		100		106					

IO-Link

IO-Link is a short distance, bi-directional, digital, point-to-point, industrial communication network standard IEC 61131-9 used for connecting sensors to either industrial fieldbus or Ethernet, in order to provide an enriched sets of data for economically optimizing industrial automated processes and operations.

An IO-Link system consists of an IO-Link master and one or more IO-Link devices, i.e. Photoelectric Sensors. The IO-Link master provides the interface to the higher-level controller (PLC) and controls the communication with the connected IO-Link devices.

An IO-Link master can have one or more IO-Link ports to which only one Device can be connected at a time. This can also be a "hub" which, as a concentrator, enables the connection of more intelligent sensors.

Intelligent, with regard to IO-Link, means that a device has identification data e.g. a type designation and a serial number or parameter data (sensitivities, switching delays or characteristic curves) that can be read or written via the IO-Link protocol. This allows parameters to be changed by the PLC during operation, for example. Intelligent also means that it can provide detailed diagnostic information.

IO-Link and the data transmitted with it are often used for preventive maintenance and servicing, e.g. it is possible to set an optical sensor in such a way that it reports via in good time if it threatens to become dirty. Cleaning no longer comes as a surprise and blocks production; it can now be put on a production break.

The parameters of the sensors and actuators are device- and technology-specific, which is why parameter information in the form of an IODD (IO Device Description) with the description language XML. The IO-Link community provides interfaces to an "IODD Finder", which can be used by engineering or master tools to present the appropriate IODD for a device.

ACCESSORIES

FIBER OPTIC	IO-LINK CONNECTIVITY	REFLECTORS	CONNECTORS
OF/OFA	MASTER IO-LINK	R	CS
			
86	166	174	178

APPLICATION PHOTOELECTRIC SENSORS

	AREA	DIMENSION		DISTANCE	
SECTION	AS	DS		DS	
PRODUCT LINE	AS1 	DS1 	DS2 	S67 	S65-M  IO-Link
OPERATING					
Slot (width) 					
Contrast 					
Luminescence 					
Contrast/Color 					
Area 	0,3...3 m				
Dimension 		0,15...4 m	0,3...10 m		
Distance 				50...300 mm (Y03) 100...600 mm (Y13)	0,3...5m (white 90%)
Vision 					
Page	112	116	120	124	130

(*) The maximum operating distance is determined by the lens used in the specific model

The table shows the maximum operating distance reached by different sensors models. Some measures indicate only the highest performances obtained by the corresponding sensor. Other operating distance values might be available for the same series and some optic functions might be carried out through LED or LASER emission, reaching different distances. For more specific information refer to the dedicated product page in this guide or download datasheets and manuals from our website (www.datalogic.com)

	FORK		CONTRAST/COLOR	LUMINESCENCE	VISION
	SR		TL	LD	SVS
S85 	SR23 	SRF 	TL46  IO-Link	LD46 	SMART VS 

RANGE					
	5 mm	30, 50, 80, 120 mm			
			9 ±3 mm (*)		
				10...50 mm (*)	
0,2...20 m					
					50...150 mm
134	140	144	148	154	158

REFERENCE GUIDE

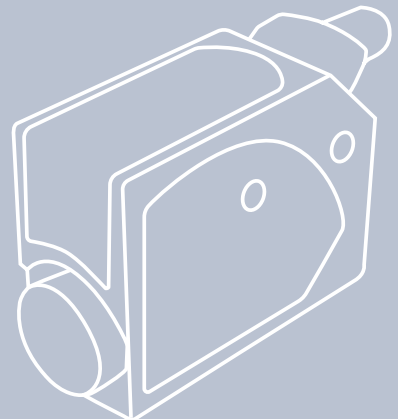
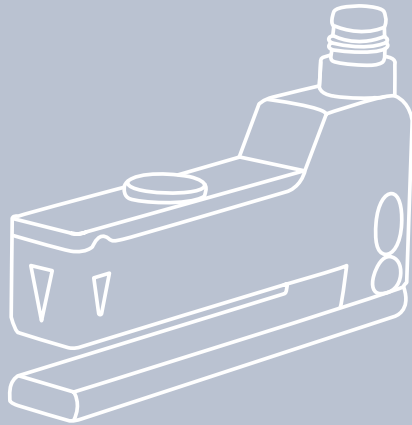
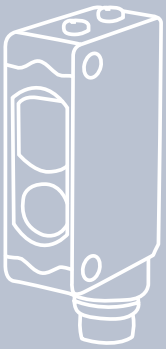

SM-ALL



COMPLETE LINE OF AMPLIFIED SUBMINIATURE PHOTOELECTRIC SENSORS

- 15mm, 20mm, 30mm and 50mm fixed focus proximity
- 1,5m retroreflective and 1m polarized retroreflective
- 2m through beam models
- Amplified NPN or PNP output with NO-NC output

APPLICATIONS

- Processing and Packaging machinery
- Electronics assembling
- Beverage & Bottling
- Vending machines



SM-ALL		
Through beam	0...2 m	
Retroreflective (on R2 reflector)	0,05...1,5 m	
Polarized retroreflective	0,1...1 m	
Fixed focus	3...15 mm	
	3...20 mm	
	3...30 mm	
	3...50 mm	
Power supply	Vdc	10...30 V
	Vac	
	Vac/dc	
Output	PNP	•
	NPN	•
	NPN/PNP	
	relay	
	other	
Connection	cable	•
	connector	
	pig-tail	
Approximate dimensions (mm)	8x23x12	
Housing material	Polycarbonate	
Mechanical protection	IP67	

TECHNICAL DATA

Power supply	10 ... 30 Vdc (limit values)
Ripple	10% max.
Consumption (output current excluded)	20 mA max.
Light emission	red LED 640 nm
Operating mode	LIGHT mode on N.O. output/DARK mode on N.C. output yellow OUTPUT LED excl. mod. G00
Indicators	green POWER LED
Output	PNP or NPN; NO; NC
Output current	50 mA max.
Saturation voltage	1,25 V max. (NPN), 1,45 V max. (PNP)
Response time	850 µs 1,3 ms (mod. SM...F00/G00)
Switching frequency	590 Hz 385 Hz (mod. SM...F00/G00)
Connection	2 m cable -2,5 mm
Dielectric strength	500 Vac, 1 min between electronics and housing
Insulating resistance	>20 MΩ, 500 Vdc between electronics and housing
Electrical protection	class 2
Mechanical protection	IP67
Ambient light rejection	according to EN 60947-5-2
Vibrations	0,5 mm amplitude, 10 ... 55 Hz frequency, for every axis (EN60068-2-6)
Shock resistance	11 ms (30 G) 6 shock for every axis (EN60068-2-27)
Housing material	Polycarbonate
Lens material	PMMA, glass (mod. B00)
Operating temperature	-20 ... 55 °C
Storage temperature	-30 ... 75 °C
Weight	22 g

DIMENSIONS

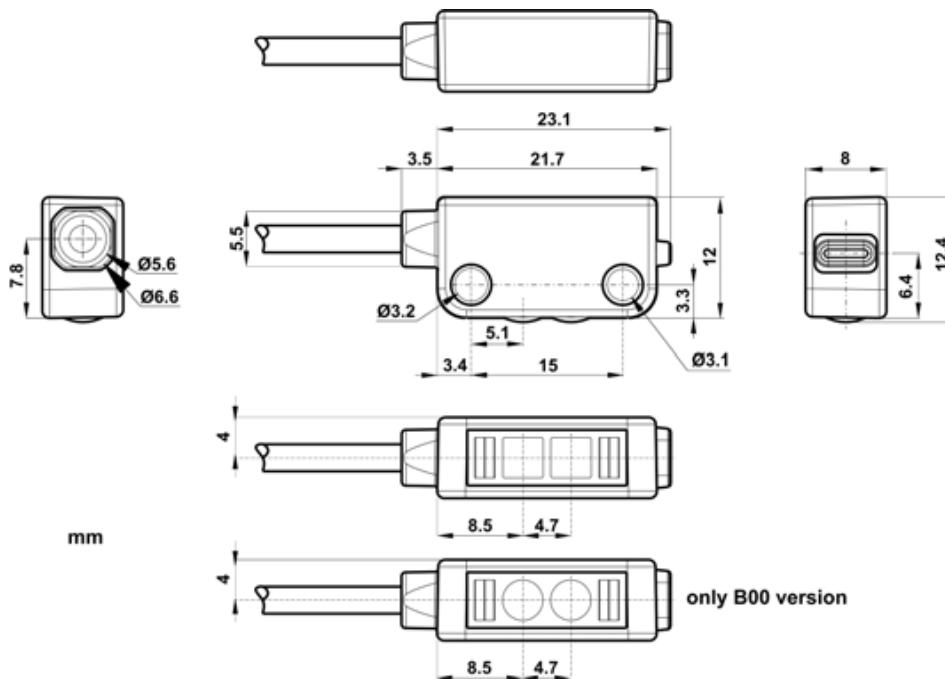

CONNECTIONS

INDICATORS AND SETTINGS

CABLE

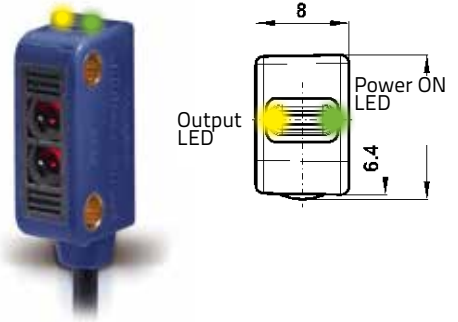
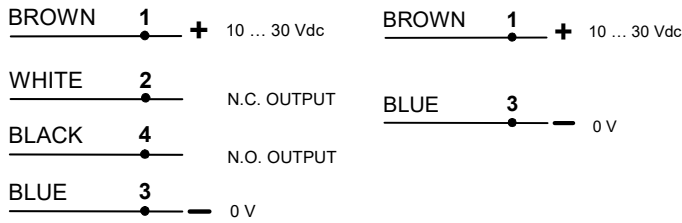

DETECTIONS DIAGRAMS

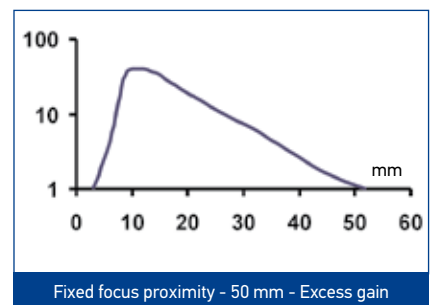
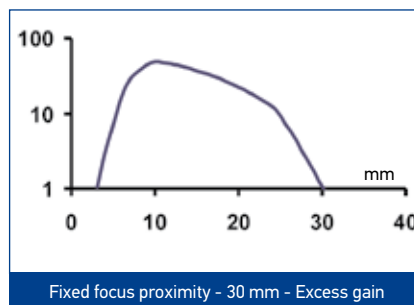
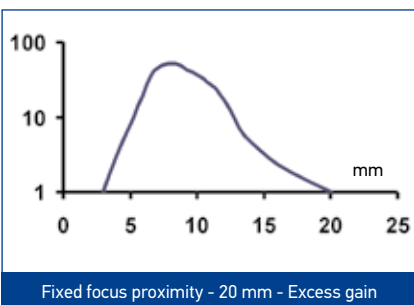
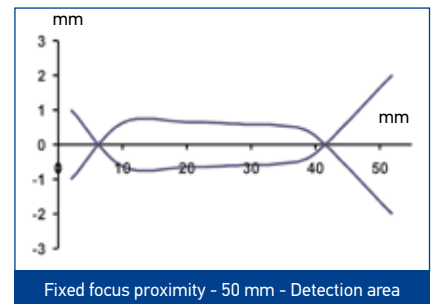
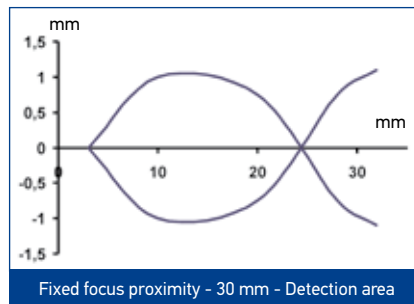
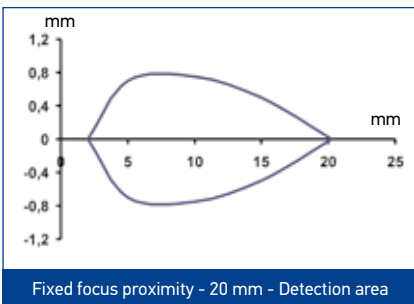
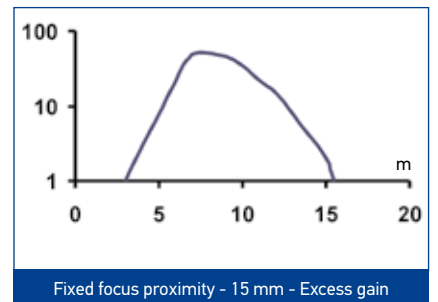
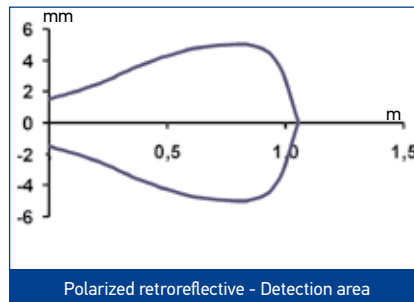
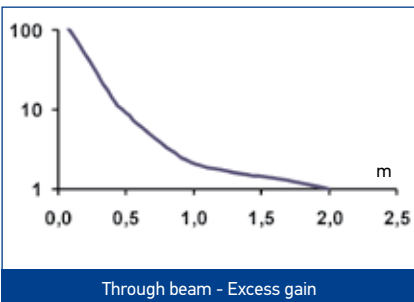
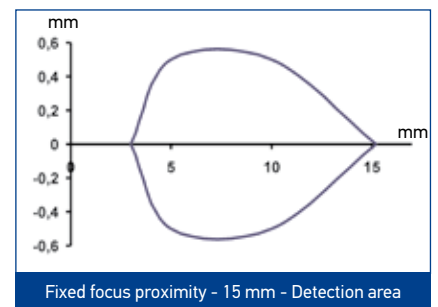
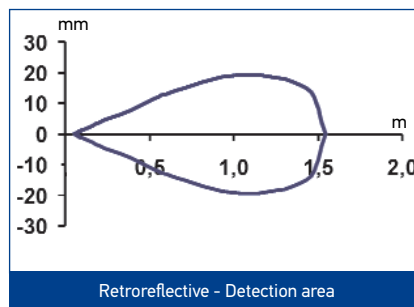
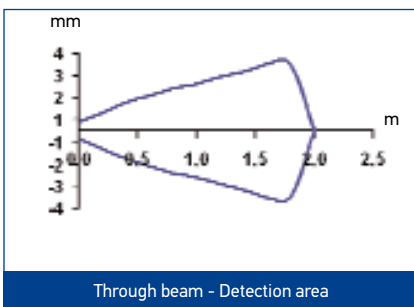

MODEL SELECTION AND ORDER INFORMATION

OPTIC FUNCTION	OPERATING DISTANCE	CONNECTION	OUTPUT	MODEL	ORDER NO.	
Retroreflective	0,05...1,5 m	2m Cable	PNP	SM-PR-2-A00-PP	95B000060	
			NPN	SM-PR-2-A00-NN	95B000070	
Polarized retroreflective	0,1...1 m	2m Cable	PNP	SM-PR-2-B00-PP	95B000080	
			NPN	SM-PR-2-B00-NN	95B000090	
Fixed focus (short distance)	15 mm	2m Cable	PNP	SM-PR-2-D00-PP	95B000020	
			NPN	SM-PR-2-D00-NN	95B000030	
Fixed focus (normal distance)	20 mm		PNP	SM-PR-2-D10-PP	95B000140	
			NPN	SM-PR-2-D10-NN	95B000150	
Fixed focus (medium distance)	30 mm		PNP	SM-PR-2-D20-PP	95B000040	
			NPN	SM-PR-2-D20-NN	95B000050	
Fixed focus (long distance)	50 mm		PNP	SM-PR-2-D30-PP	95B000000	
			NPN	SM-PR-2-D30-NN	95B000010	
Through beam receiver	0...2 m		2m Cable	PNP	SM-PR-2-F00-PP	95B000120
				NPN	SM-PR-2-F00-NN	95B000130
		-		SM-PR-2-G00-XG	95B000160	

ACCESSORIES

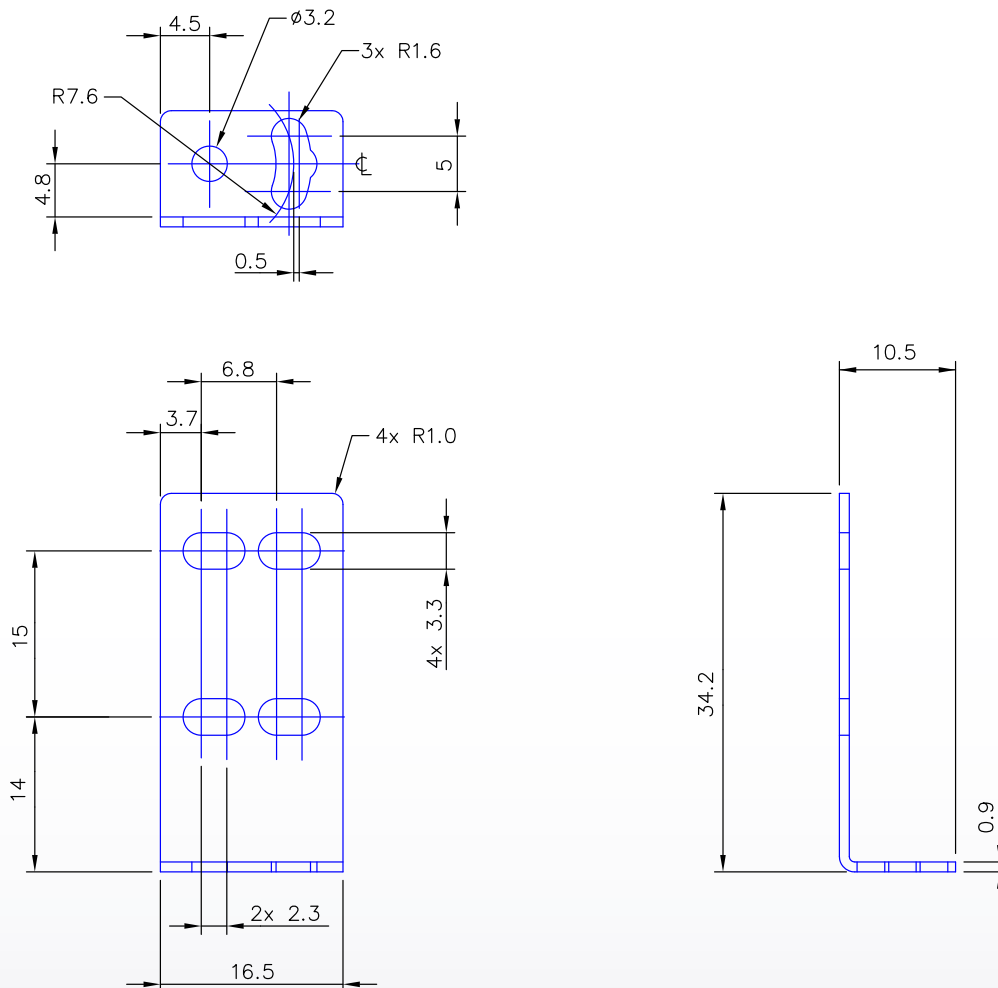

MODEL	DESCRIPTION	ORDER NO.
ST-5049	right angle bracket	95ACC6650

S100

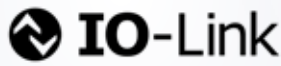

New ASIC



THE UNIVERSAL MINIATURE PHOTOELECTRIC SENSOR

- Two threaded front mounting holes
- Two slotted rear mounting holes
- Anti-tampering sensor (no adjustment)
- High speed high resolution RGB contrast sensor available
- Transparent object detection
- M8 connector and cable models
- PNP or NPN models with Light/Dark selection by wire
- Plastic housing, IP67 mechanical protection
- IO-Link COM2 communication protocol
- IO-Link V1.1.2 version
- IO-Link extended parametrization for monitoring and maintenance

APPLICATIONS

- Processing and packaging machines
- Conveyors
- Automatic warehousing
- Intralogistic lines
- Bottling
- Cosmetic and Pharma machinery
- Industry 4.0 application compliant

S100

Through beam		12 m
Retroreflective		7 m
Polarized Retroreflective (long range)		5,5 m
Polarized Retroreflective (short range)		3 m
Transparent Retroreflective (short range)		500 mm
Transparent Retroreflective (long range)		2 m
Diffused proximity (short range)		300 mm
Diffused proximity (long range)		500 mm
Fixed focus		70 mm
Background Suppression (short range)		100 mm
Background Suppression (long range)		200 mm
RGB Mark Reader		12,5mm+/-2mm
Power supply	Vdc	10...30 Vdc
Output	PNP	•
	NPN	•
Connectivity	IO-Link	IO-Link V1.1.2 Smart Sensor Profile Fully programmable double output stage through IO-Link parametrization
Connection	cable	2 m cable, 4 wires
	connector	M8 conn., 4-pole
Approximate dimensions (mm)		32x20x12
Housing material		Plastic
Mechanical protection		IP67

TECHNICAL DATA

Power supply	10 ... 30 Vdc
Ripple	10% max.
Consumption (output current excluded)	35 mA max. (mod. S100...W) 30 mA max. (mod. S100...B/M/ T IO-Link) red LED 632 nm (mod. S100...B/C/D/M01) IR LED 860 nm (mod. S100...A/G/Txx/M10) RGB LED (mod. S100-W00)
Light emission	
Spot size	1.5mm x 6.5mm (mod. S100-W00)
Setting	remote teach-in (mod. S100...Mxx/Txx/W00)
Operating mode	LIGHT/DARK selectable by wire (mod. S100...A/B/C/D/F) yellow OUTPUT LED (excl. mod. G) green POWER LED (mod. S100...G)
Indicators	PNP or NPN
Output	Fully programmable output stage only in IO-Link model Pin 2 I/O programmable only for IO-Link models
Output current	100 mA
IO-Link Connectivity	V1.1.2
IO-Link COM	COM2
IO-Link min cycle	2.3ms
Saturation voltage	2 V max.
Response time	2 ms (mod. S100...FG) 1 ms (mod. S100...A/Bxx/C/D/Mxx/Txx/T IO-Link), 500µs (B IO-Link), 25µs (W00-xx)
Switching frequency	250 Hz (mod. S100...FG) 500 Hz (mod. S100...A/Bxx/C/D/Mxx/Txx/T IO-Link), 1KHz (B IO-Link), 20kHz (W00-xx)
Jitter	13µs(W00-xx)
Connection	2 m cable Ø 3,5 mm, M8 4-pole connector
Dielectric strength	500 Vac, 1 min between electronics and housing
Insulating resistance	>20 MΩ, 500 Vdc between electronics and housing
Mechanical protection	IP67
Ambient light rejection	according to EN 60947-5-2
Vibrations	0,5 mm amplitude, 10 ... 55 Hz frequency, for every axis (EN60068-2-6)
Shock resistance	11 ms (30 G) 6 shock for every axis (EN60068-2-27)
Housing material	ABS body, PMMA indicators cover
Lens material	PC lens, PMMA window
Operating temperature	-25... 55 °C
Storage temperature	-40 ... 70 °C
Weight	50 g max. cable vers., 10 g max. connector vers.

DIMENSIONS

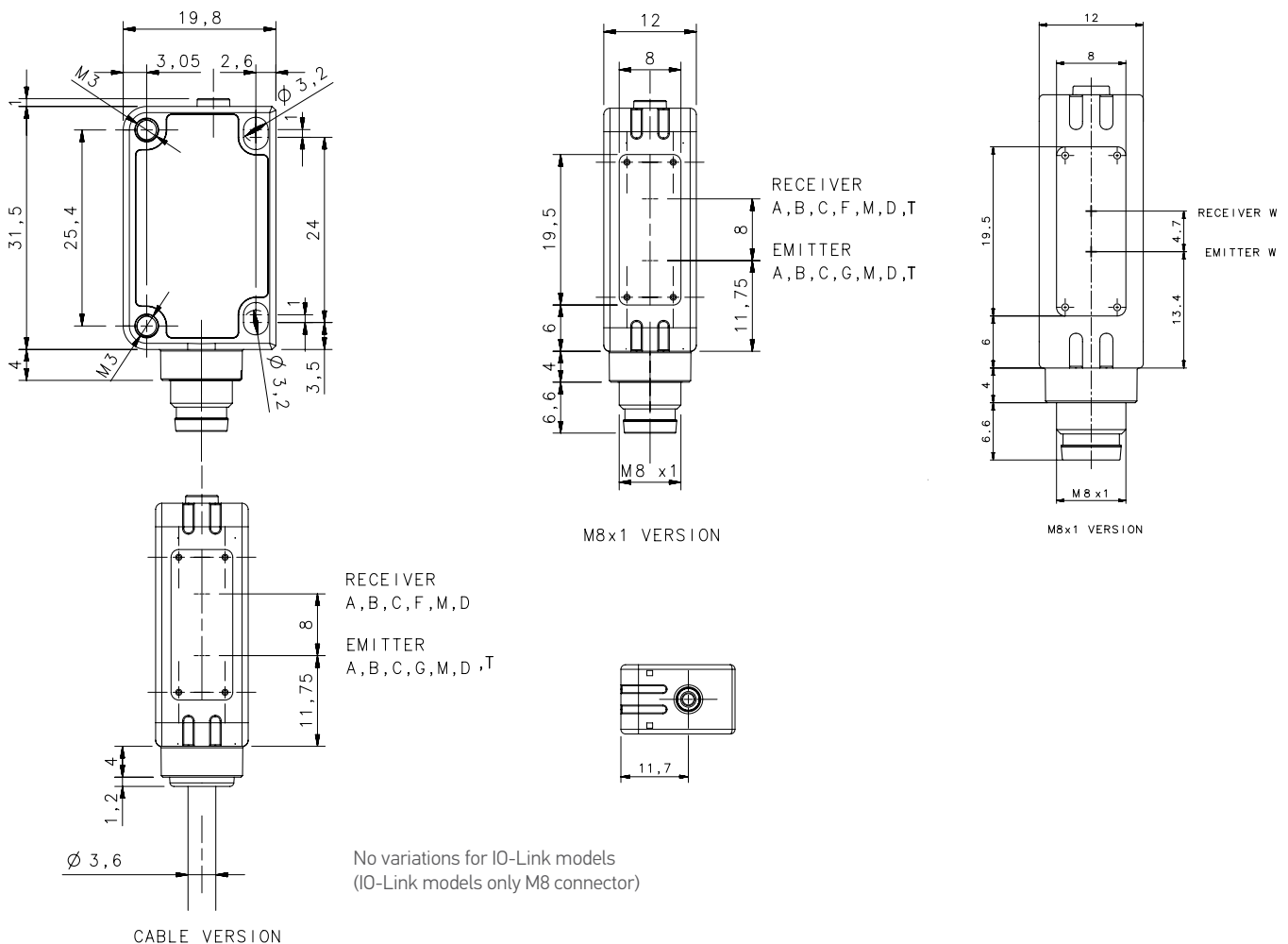

CONNECTIONS

M8 CONNECTOR

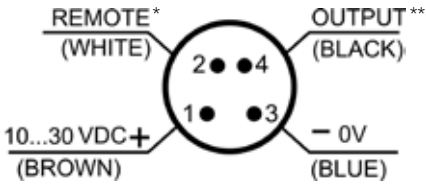

CABLE

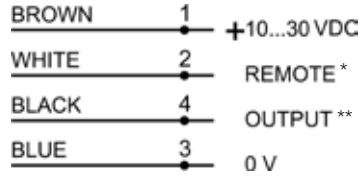

S100-PR-5-(B10, M10, T10, W00)-OZ

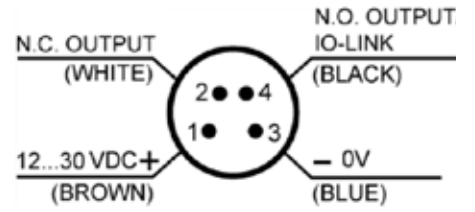

*REMOTE: Light/Dark selection (S100-...-A-B-C-D-F), External Teach-in (S100-...-Mxx/Txx/W00)
 **OUTPUT: PNP or NPN depends on the model

Pin 2 I/O programmable only for IO-Link models

INDICATORS AND SETTINGS

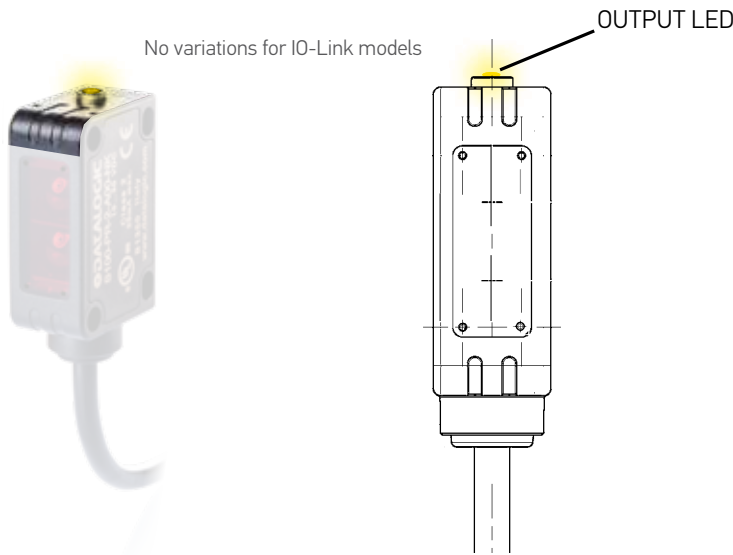

DETECTION DIAGRAMS

THROUGH BEAM

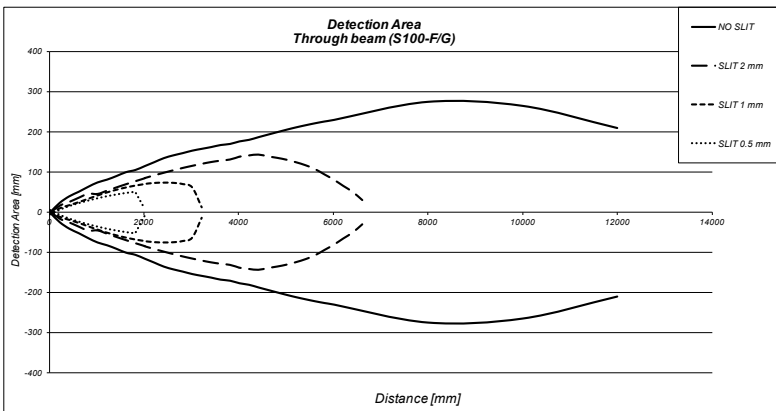

	max. operating distance
NO SLIT	12 m
2 mm SLIT	6,7 m
1 mm SLIT	3,2 m
0,5 mm SLIT	2 m

DIFFUSE PROXIMITY

	SHORT RANGE (S100-...-C0)	LONG RANGE (S100-...-C1)
Recommended operating distance (on White 90% target)	10...240 mm	2...400 mm
Maximum operating distance (White 90% target)	1...300 mm	0...500 mm
Maximum operating distance (Grey 18% target)	20...150 mm	10...280 mm
Maximum operating distance (Black 6% target)	30...80 mm	20...160 mm
Difference White-Grey	50%	50%
Difference White-Black	75%	75%
Hysteresis	20%	20%

DIFFUSE (SHORT RANGE: S100-C00)

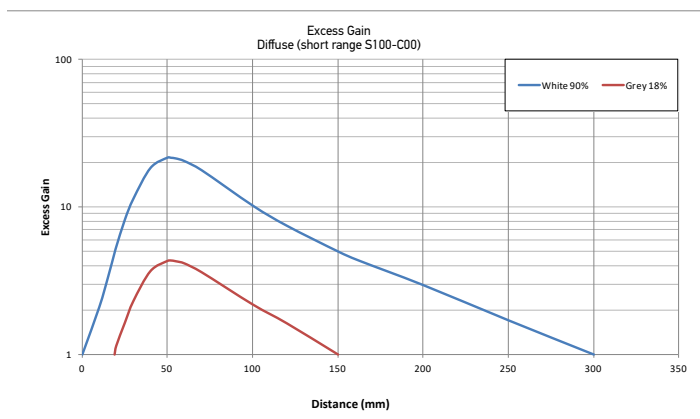
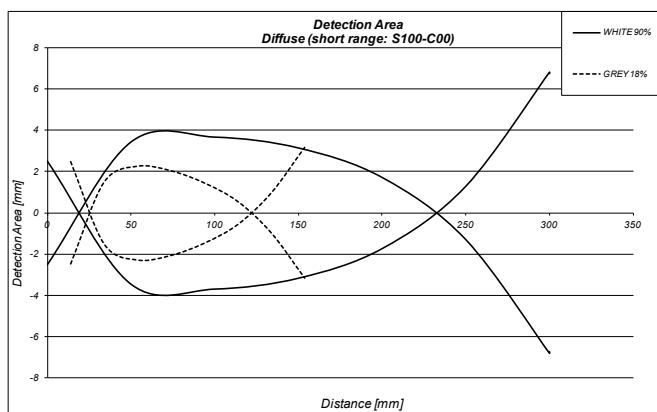

DIFFUSE (LONG RANGE: S100-C10)

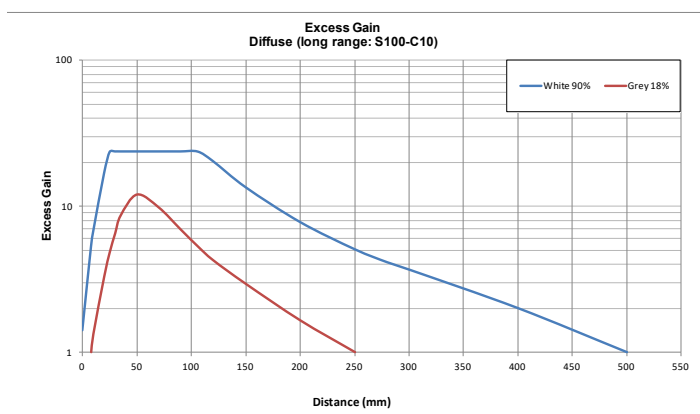
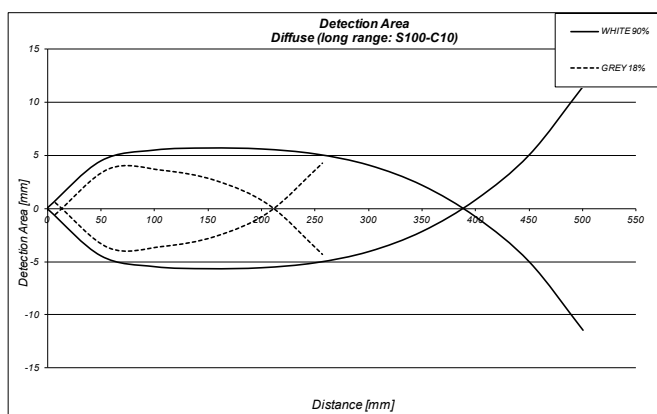

POLARIZED RETROREFLECTIVE

REFLECTOR	TYPE	SHORT RANGE (S100-...-B00)	LONG RANGE (S100-...-B10) IO-Link
R1	circular (23 mm)	0,2..0,8 m	0,02..2 m
R2	circular (48 mm)	0,03..2 m	0,01..4,5 m
R3	rectangular (18x54 mm)	0,03..1,5 m	0,01..3 m
R4	rectangular (47x47 mm)	0,03..2,5 m	0,01..4,5 m
R5	circular (75 mm)	0,01..3 m	0,01..5,5 m
R6	rectangular (36x55 mm)	0,03..1,8 m	0,01..4 m
RT3970	self-adhesive tape (60x40 mm)	0,2..0,8 m	0,05..1,8 m



	max. operating distance			
	SHORT RANGE (S100-...-B00)		LONG RANGE (S100-...-B10) IO-Link	
	with R5 reflector	with R2 reflector	with R5 reflector	with R2 reflector
NO SLIT	0,02 ... 3 m	0,02 ... 2 m	0,1...5,5 m	0,01...4,5 m
2 mm SLIT	0,05 ... 1,5 m	0,05 ... 0,8 m	0,2...4 m	0,03...3 m
1 mm SLIT	-	-	0,3...2,5 m	0,05...1,5 m
0,5 mm SLIT	-	-	0,5...1,2 m	0,07...0,7 m

POLARIZED RETROREFLECTIVE (SHORT RANGE: S100-B00)

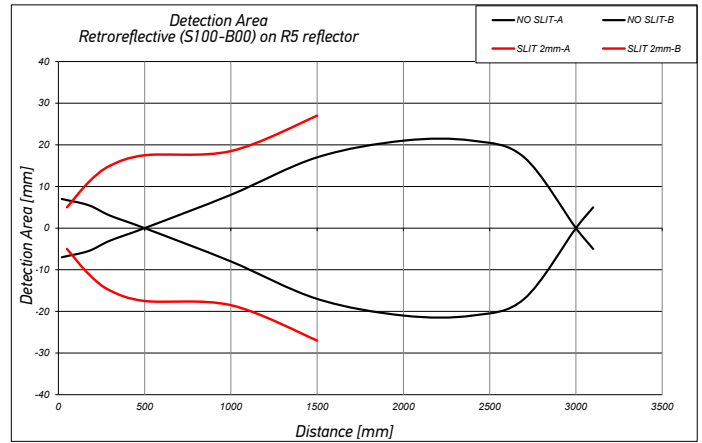
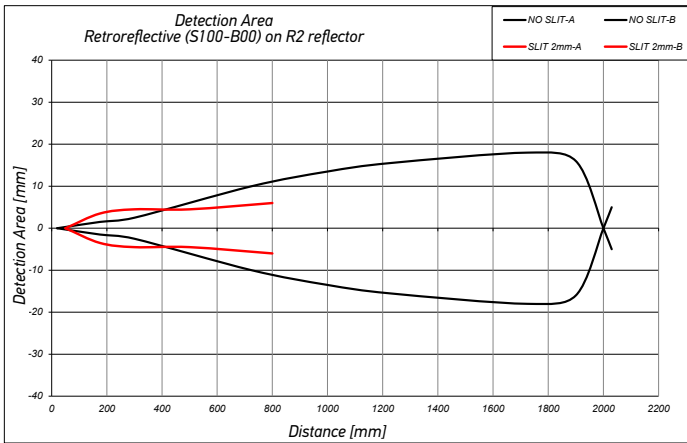

IO-Link POLARIZED RETROREFLECTIVE (LONG RANGE: S100-PR-5-B10-PK, ...-OZ)

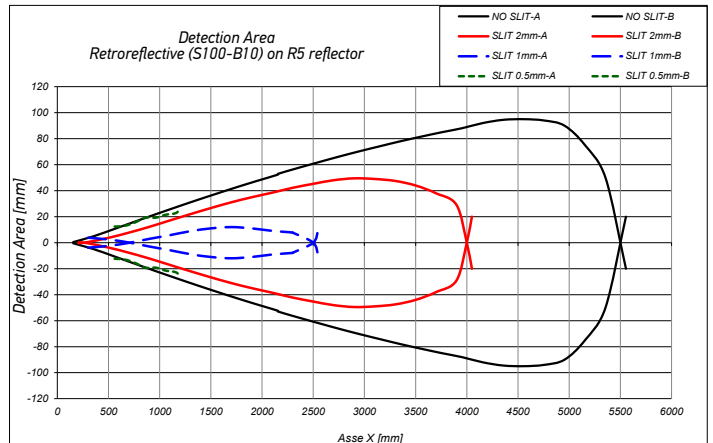
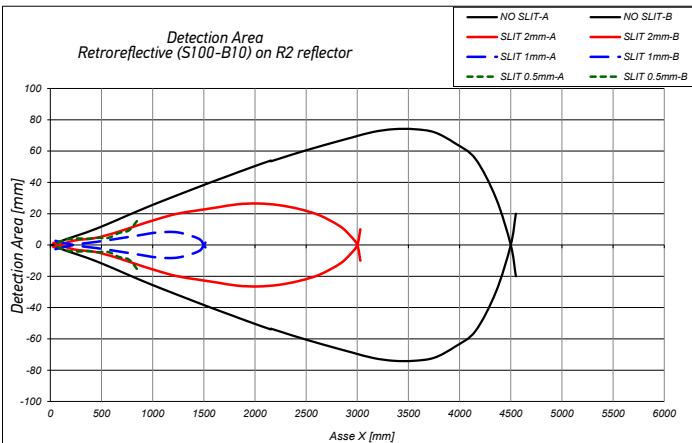

RETROREFLECTIVE (INFRARED)

REFLECTOR	TYPE	(S100-...-A00)
R1	circular (23 mm)	0.03..3 m
R2	circular (48 mm)	0.01..6 m
R3	rectangular (18x54 mm)	0.01..3.5 m
R4	rectangular (47x47 mm)	0.01..5 m
R5	circular (75 mm)	0.01..7 m
R6	rectangular (36x55 mm)	0.01..6 m
RT3970	self-adhesive tape (60x40 mm)	0,05..2 m



	max. operating distance	
	with R5 reflector	with R2 reflector
NO SLIT	7 m	6 m
2 mm SLIT	4,7 m	3,4 m
1 mm SLIT	2,7 m	2,3 m
0,5 mm SLIT	1,5 m	1 m

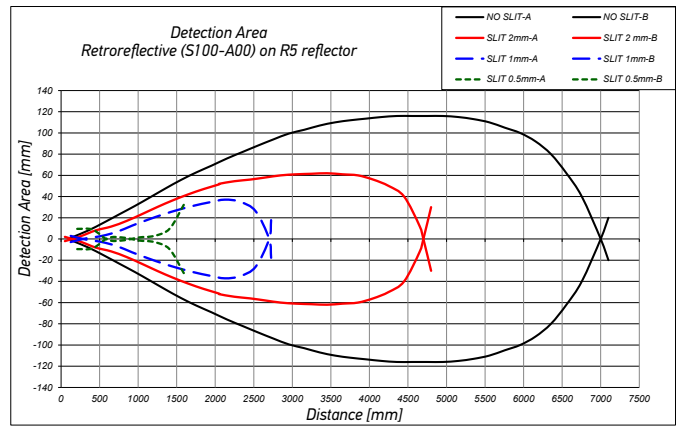
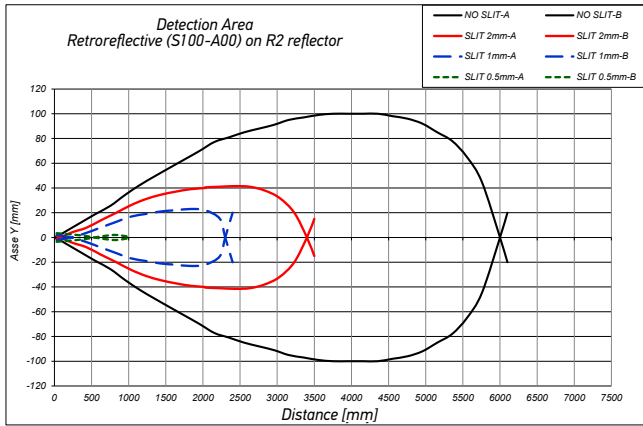

FIXED FOCUS

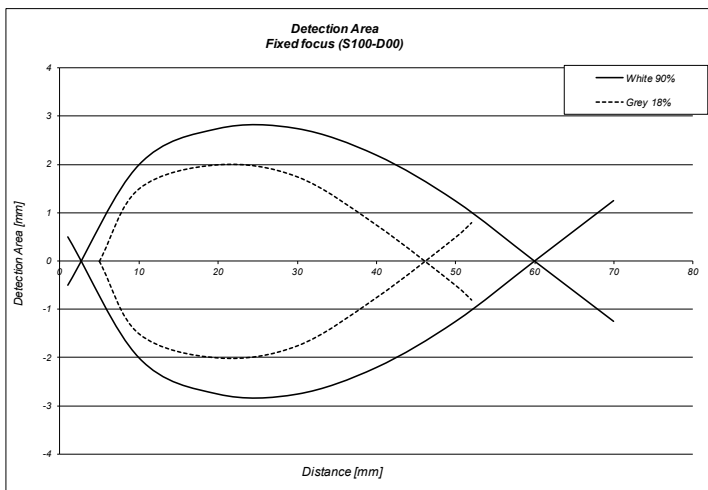

Focus point	70 mm
Maximum operating distance (White 90%)	70 mm
Maximum operating distance (Grey 18%)	55 mm
Difference White/Black	25%

RETROREFLECTIVE FOR TRANSPARENT (INFRARED)

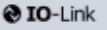
REFLECTOR	TYPE	SHORT RANGE (S100-...-T00)	LONG RANGE (S100-...-T10)	LONG RANGE (S100-...-T10) 
R1	circular (23 mm)	0.1...0.3 m	0.4...1 m	0.1...1 m
R2	circular (48 mm)	0.1...0.5 m	0.8...2 m	0.1...2 m
R3	rectangular (18x54 mm)	0.1...0.3 m	0.4...1 m	0.1...1 m
R4	rectangular (47x47 mm)	0.1...0.5 m	0.8...2 m	0.1...2 m
R5	circular (75 mm)	0.1...0.8 m	0.8...2.5 m	0.1...2.5 m
R6	rectangular (36x55 mm)	0.1...0.5 m	0.8...2m	0.1...2m
RT3970	self-adhesive tape (60x40 mm)	0.15...0.3 m	0.1...0.8 m	0.1...0.8 m



	max. operating distance				
	SHORT RANGE (S100-...-T00)		LONG RANGE (S100-...-T10)		LONG RANGE (S100-...-T10) 
	with R5 reflector	with R2 reflector	with R5 reflector	with R2 reflector	with R2 reflector
NO SLIT	0.1...0.8 m	0.1...0.5 m	0.8...2.5 m	0.8...2 m	0.1...2 m
2 mm SLIT	0.1...0.5 m	0.1...0.3 m	0.5...1.8 m	0.5...1.6 m	0.1...1.6 m
1 mm SLIT	-	-	-	-	-
0,5 mm SLIT	-	-	-	-	-

TRANSPARENT RETROREFLECTIVE (SHORT RANGE: S100-T00)

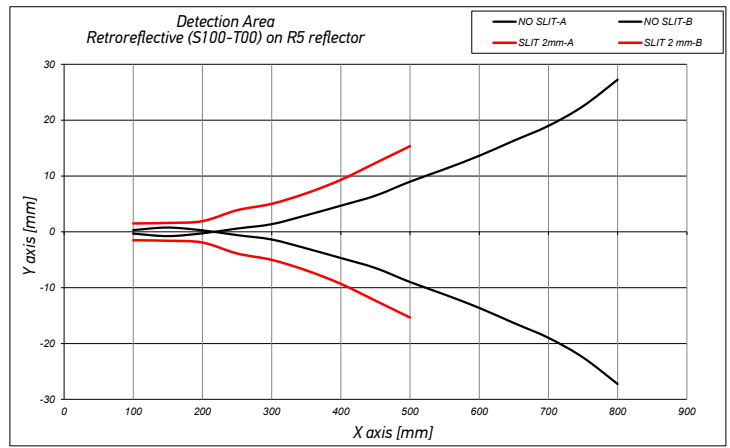
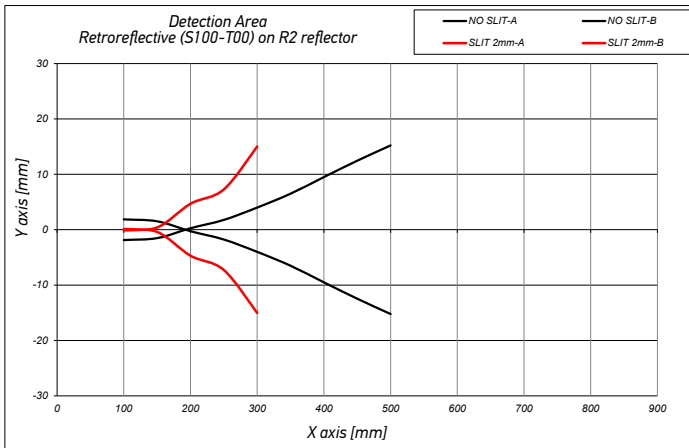

TRANSPARENT RETROREFLECTIVE (LONG RANGE: S100-PR-5-T10-PH, ...OZ)

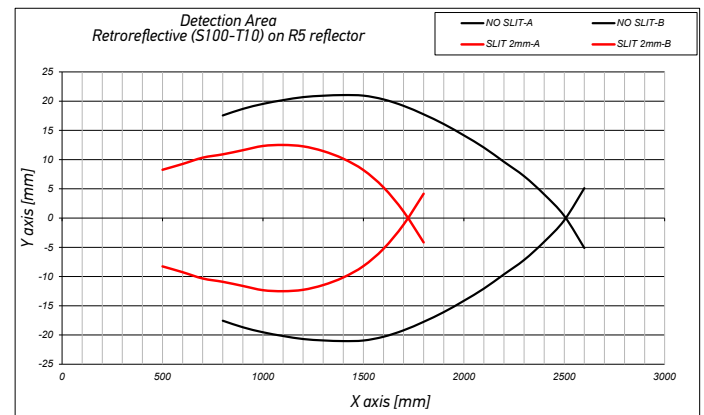
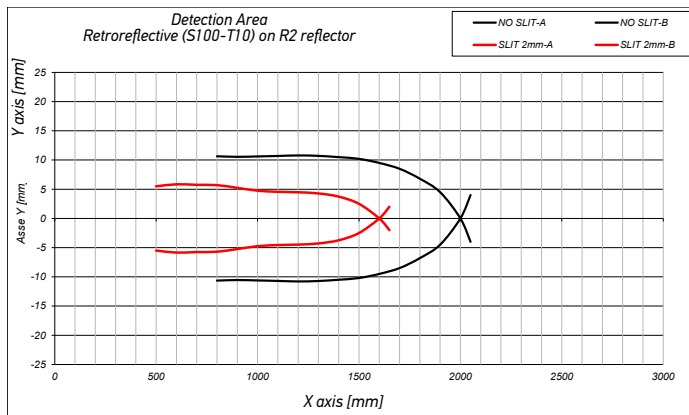

BACKGROUND SUPPRESSION

Operating distances (background suppression)	30...100 mm	30...200 mm	
	S100...M00	S100...M10	S100...M10 
Maximum operating distance (White 90%)	0...150 mm	10...250 mm	10...210 mm
Maximum operating distance (Grey 18%)	10...110 mm	10...135 mm	10...180 mm
Maximum operating distance (Black 6%)	10...80 mm	10...110 mm	10...125 mm
Difference White 90%/White 90%	< 5%	< 10%	< 10%
Difference White 90%/Grey 18%	< 15%	< 32%	< 23%
Difference White 90%/Black 6%	< 25%	< 45%	< 35%

BACKGROUND SUPPRESSION (SHORT RANGE: S100-M00)

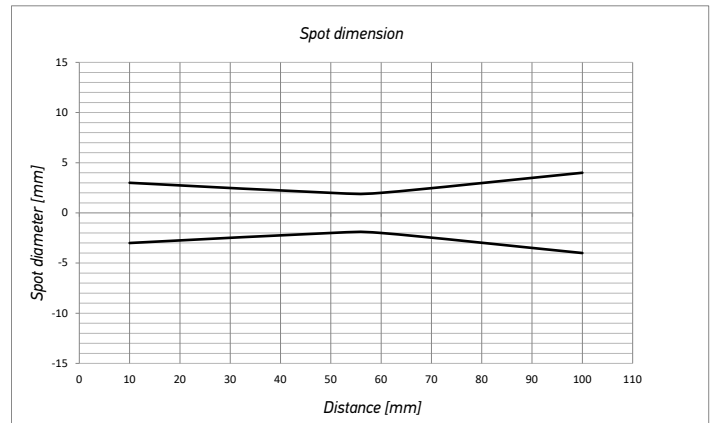
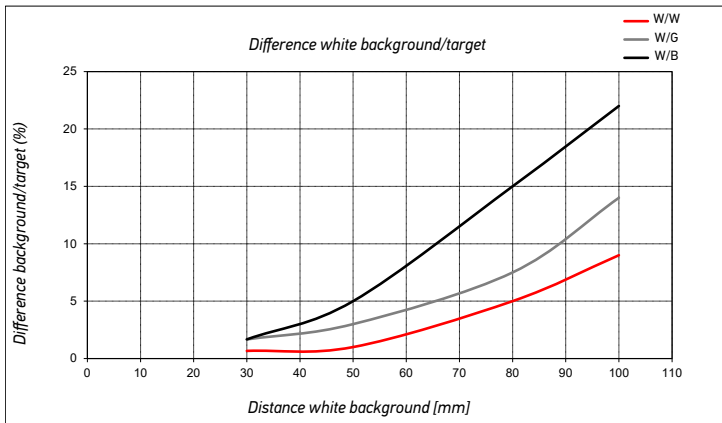

BACKGROUND SUPPRESSION (LONG RANGE: S100-PR-5-M10-PH)

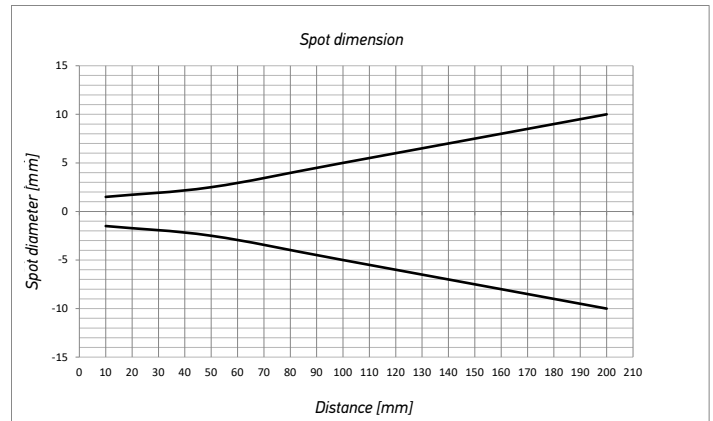
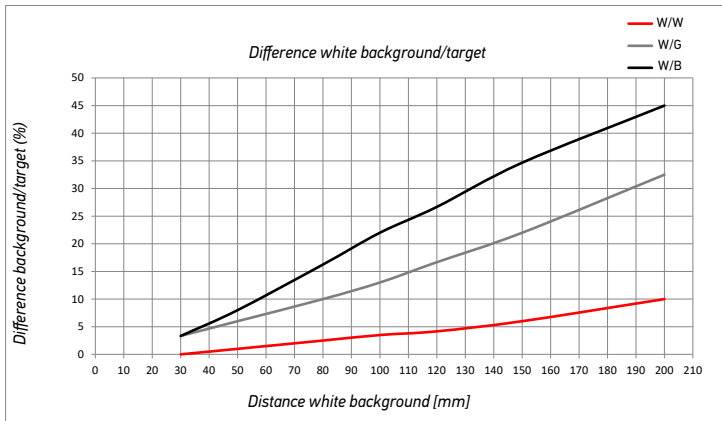

BACKGROUND SUPPRESSION (LONG RANGE: S100-PR-5-M10-OZ)

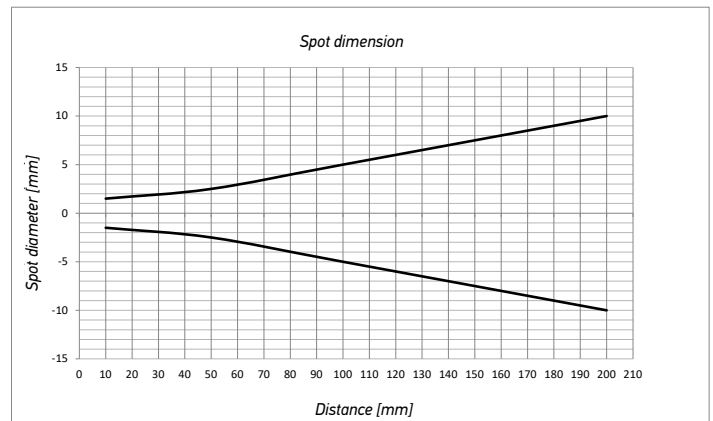
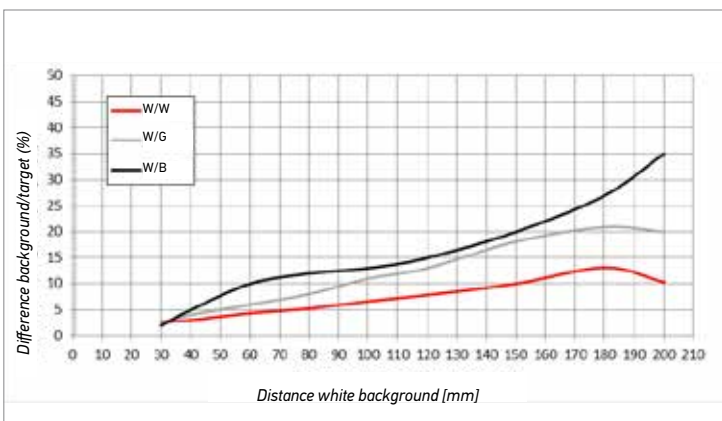

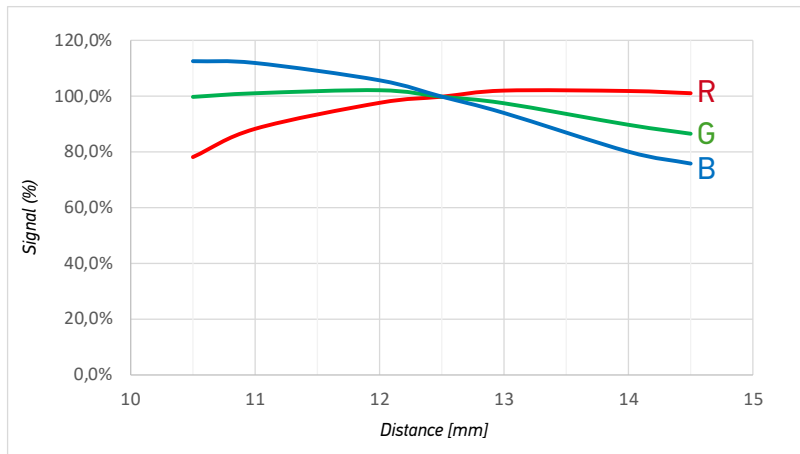

MODEL SELECTION AND ORDER INFORMATION

OPTIC FUNCTION	EMISSION	OPERATING DISTANCE	CONNECTION	OUTPUT	MODEL	ORDER NO.
Through beam	IR	12 m	2 m cable	NPN	S100-PR-2-FG00-NK	950811100
				PNP	S100-PR-2-FG00-PK	950811110
			M8 connector	NPN	S100-PR-5-FG00-NK	950811240
				PNP	S100-PR-5-FG00-PK	950811250
Retroreflective	IR	7 m	2 m cable	NPN	S100-PR-2-A00-NK	950811000
				PNP	S100-PR-2-A00-PK	950811010
			M8 connector	NPN	S100-PR-5-A00-NK	950811140
				PNP	S100-PR-5-A00-PK	950811150
Polarized Retroreflective (short)	RED	2 m	2 m cable	NPN	S100-PR-2-B00-NK	950811020
				PNP	S100-PR-2-B00-PK	950811030
			M8 connector	NPN	S100-PR-5-B00-NK	950811160
				PNP	S100-PR-5-B00-PK	950811170
Polarized Retroreflective (long)	RED	5 m	2 m cable	NPN	S100-PR-2-B10-NK	950811280
				PNP	S100-PR-2-B10-PK	950811290
			M8 connector	NPN	S100-PR-5-B10-NK	950811300
				PNP	S100-PR-5-B10-PK	950811310
				S100-PR-5-B10-OZ	950810001	
Transparent Retroreflective (short)	IR	500 mm	2 m cable	NPN	S100-PR-2-T00-NH	950811330
				PNP	S100-PR-2-T00-PH	950811320
			M8 connector	NPN	S100-PR-5-T00-NH	950811350
				PNP	S100-PR-5-T00-PH	950811340
Transparent Retroreflective (long)	IR	2 m	2 m cable	NPN	S100-PR-2-T10-NH	950811370
				PNP	S100-PR-2-T10-PH	950811360
			M8 connector	NPN	S100-PR-5-T10-NH	950811390
				PNP	S100-PR-5-T10-PH	950811380
				S100-PR-5-T10-OZ	950810002	
Diffuse proximity (short)	RED	300 mm	2 m cable	NPN	S100-PR-2-C00-NK	950811040
				PNP	S100-PR-2-C00-PK	950811050
			M8 connector	NPN	S100-PR-5-C00-NK	950811180
				PNP	S100-PR-5-C00-PK	950811190
Diffuse proximity (long)	RED	500 mm	2 m cable	NPN	S100-PR-2-C10-NK	950811060
				PNP	S100-PR-2-C10-PK	950811070
			M8 connector	NPN	S100-PR-5-C10-NK	950811200
				PNP	S100-PR-5-C10-PK	950811210
Fixed focus	RED	70 mm	2 m cable	NPN	S100-PR-2-D00-NK	950811080
				PNP	S100-PR-2-D00-PK	950811090
			M8 connector	NPN	S100-PR-5-D00-NK	950811220
				PNP	S100-PR-5-D00-PK	950811230
Background suppression (short range)	RED	30...100 mm	2 m cable	NPN	S100-PR-2-M00-NH	950811120
				PNP	S100-PR-2-M00-PH	950811130
			M8 connector	NPN	S100-PR-5-M00-NH	950811260
				PNP	S100-PR-5-M00-PH	950811270
Background suppression (long range)	IR	30...200 mm	2 m cable	NPN	S100-PR-2-M10-NH	950811420
				PNP	S100-PR-2-M10-PH	950811430
			M8 connector	NPN	S100-PR-5-M10-NH	950811400
				PNP	S100-PR-5-M10-PH	950811410
				S100-PR-5-M10-OZ	950810003	
Mark Reader	RGB	12mm +/-2mm	M8 connector	PNP	S100-PR-5-W00-PK	950810005
					S100-PR-5-W00-OZ	950810004

ACCESSORIES

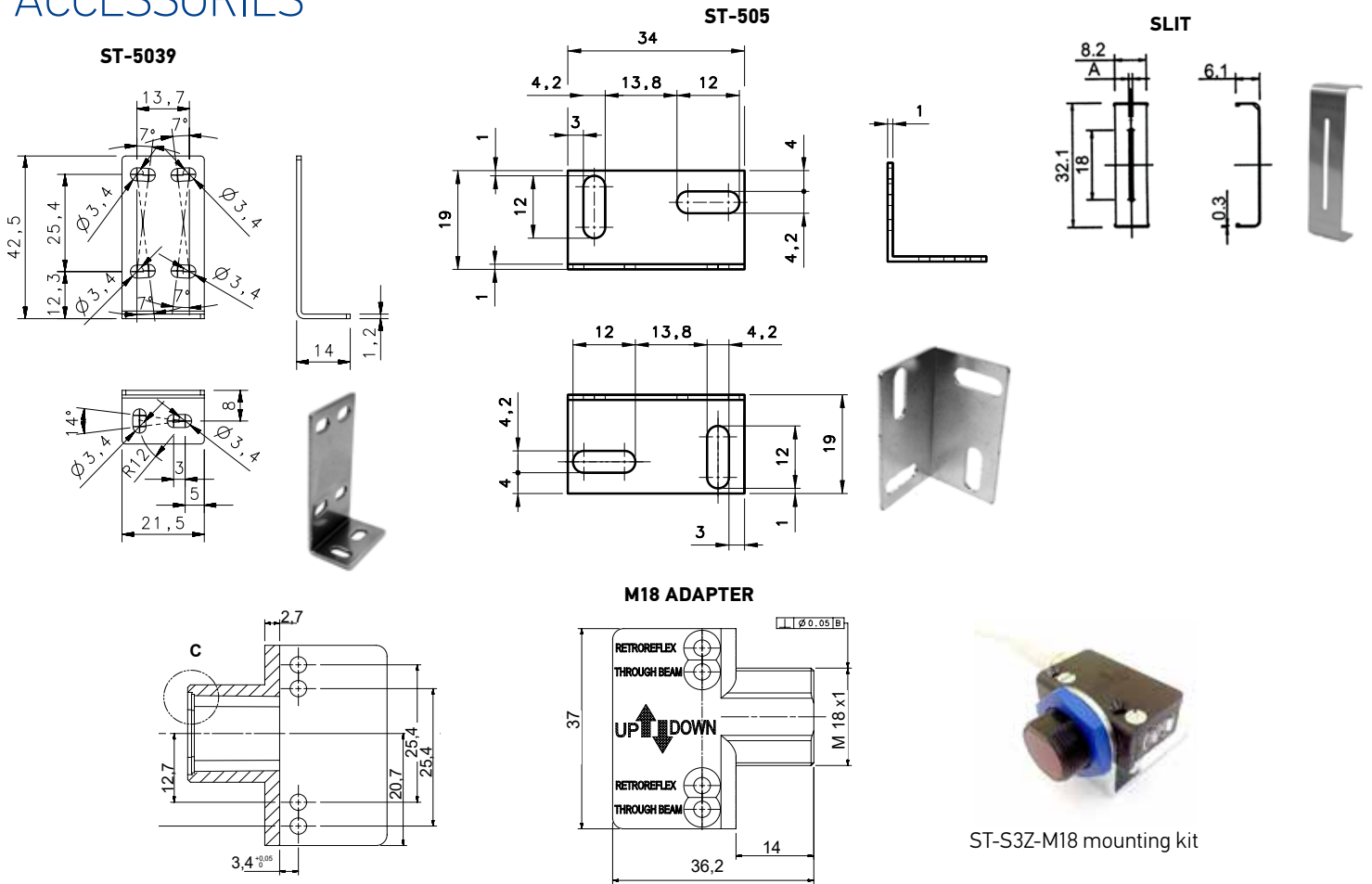

TYPE	MODEL	DESCRIPTION	ORDER NO.
Mounting bracket	ST-505	lateral mounting	95ACC2800
	ST-5039	L-shaped bracket	95ACC2270
Slit	S100-SLIT-05	0,5x19 mm SLIT	95ACC3450
	S100-SLIT-1	1x19 mm SLIT	95ACC3460
	S100-SLIT-2	2x19 mm SLIT	95ACC3470
M18 adapter	ST-S3Z-M18 mounting kit	M18 THREADED ADAPTER NOSE	95ACC7850

IO-LINK CONNECTIVITY		
MODEL	DESCRIPTION	ORDER No.
CBX-8IOL-EIP	CBX-8IOL-EIP 8P IOL M12 EIP MASTER	95ACC8180
CBX-8IOL-PNIO	CBX-8IOL-PNIO 8P IOL M12 PROFINET MASTER	95ACC8190

CABLES					
TYPE	DESCRIPTION	LENGTH	MODEL	ORDER NO.	
Axial M8 Connector	4-pole, grey, P.V.C.	3 m	CS-B1-02-G-03	95A251420	
		5 m	CS-B1-02-G-05	95A251430	
		7 m	CS-B1-02-G-07	95A251440	
		10 m	CS-B1-02-G-10	95A251480	
Radial M8 Connector	4-pole, P.U.R.	2 m	CS-B1-02-R-02	95A251620	
		5 m	CS-B1-02-R-05	95A251640	
		4-pole, grey, P.V.C.	3 m	CS-B2-02-G-03	95A251450
			5 m	CS-B2-02-G-05	95A251460
7 m	CS-B2-02-G-07		95A251470		
Axial M12 F/M8 M Connector	4-pole, double headed	10 m	CS-B2-02-G-10	95A251530	
		2 m	CS-B2-02-R-02	95A251630	
		5 m	CS-B2-02-R-05	95A251650	
		3 m	CS-H1-02-B-03	95ACC0008	

S3Z



ADVANCED GLOBAL STYLE MINIATURE PHOTOELECTRIC SENSOR



- 50-250 mm background suppression
- 0.7 m proximity, 150 mm with narrow beam
- 4 m polarized retroreflective
- 15 m through beam
- Light and dark trimmer models
- Standard 3-wire output configuration

APPLICATIONS

- Processing and Packaging machinery
- Electronics assembling
- Transportation lines, material handling
- Automatic warehouses
- Cosmetics and Pharmaceutical industry
- Small part detection with maximum accuracy



S3Z		
Through beam	0...15 m 0...30 m (class 1 LASER)	
Polarized retroreflective	0.05...4 m 0,3...10 m (class 1 LASER)	
Retroreflective for transparent (on R2 reflector)	0...2 m	
Diffuse proximity	0...700 mm 50...150 mm (narrow beam)	
Background suppression	50...250 mm 40...300 mm (class 1 LASER)	
Power supply	Vdc	10...30 V
	Vac	
	Vac/dc	
Output	PNP	•
	NPN	•
	NPN/PNP	
	relay	
	other	
Connection	cable	•
	connector	•
	pig-tail	
Approximate dimensions (mm)	11x31x19	
Housing material	PC/PBT	
Mechanical protection	IP67	

TECHNICAL DATA

Consumption (output current excluded)	30 mA max. (LED mod.) 35 mA max. (Laser mod.)
Light emission	red LED 650 nm (mod. S3Z...T51) red LED 665 nm (mod. S3Z...B01/C01) red LED 670 nm (mod. S3Z...M01) IR LED 850 nm (mod. S3Z...C11) IR LED 870 nm (mod. S3Z...F01/G00) red Laser 650 nm (mod. S3Z...B01/F01/G00/M01)
Setting	sensitivity trimmer, 6 turns screw (mod. S3Z...M01), one turn sensitivity trimmer
Operating mode	LIGHT/DARK trimmer (Laser mod. S3Z...-PP, -NN), LIGHT (mod. S3Z...-PL, -NL), DARK (mod. S3Z...-PD, -ND)
Indicators	yellow OUTPUT LED, green STABILITY LED (mod. S3Z...B01/C01/C11/F01), POWER ON LED (mod. S3Z...G00)
Output	PNP or NPN (short circuit protection)
Output current	100 mA max.
Saturation voltage	2 V max. (LED mod.) 1,5 V max. (Laser mod.)
Response time	1 ms max. (LED mod.) 250 µs max. (Laser mod.)
Switching frequency	500 Hz max. (LED mod.) 2 kHz max. (Laser mod.)
Connection	2 m cable Ø 3,5 mm, M8 4-pole connector
Dielectric strength	500 Vac 1 min., between electronics and housing
Insulating resistance	>20 MΩ 500 Vdc, between electronics and housing
Mechanical protection	IP67
Ambient light rejection	according to EN 60947-5-2
Vibration	0.5 mm amplitude, 10 ... 55 Hz frequency, for every axis (EN60068-2-6)
Shock resistance	11 ms (30 G) 6 shock for every axis (EN60068-2-27)
Housing material	body PBT, indicators cover PC
Lens material	PMMA, PC (mod. S3Z...B01)
Operating temperature	-25 ... 55 °C (LED mod.), -10 ... 55 °C (Laser mod.)
Storage temperature	-40 ... 70 °C (LED mod.), -25 ... 70 °C (Laser mod.)
Weight	50 g max. cable vers. , 10 g max. conn. vers.

DIMENSIONS

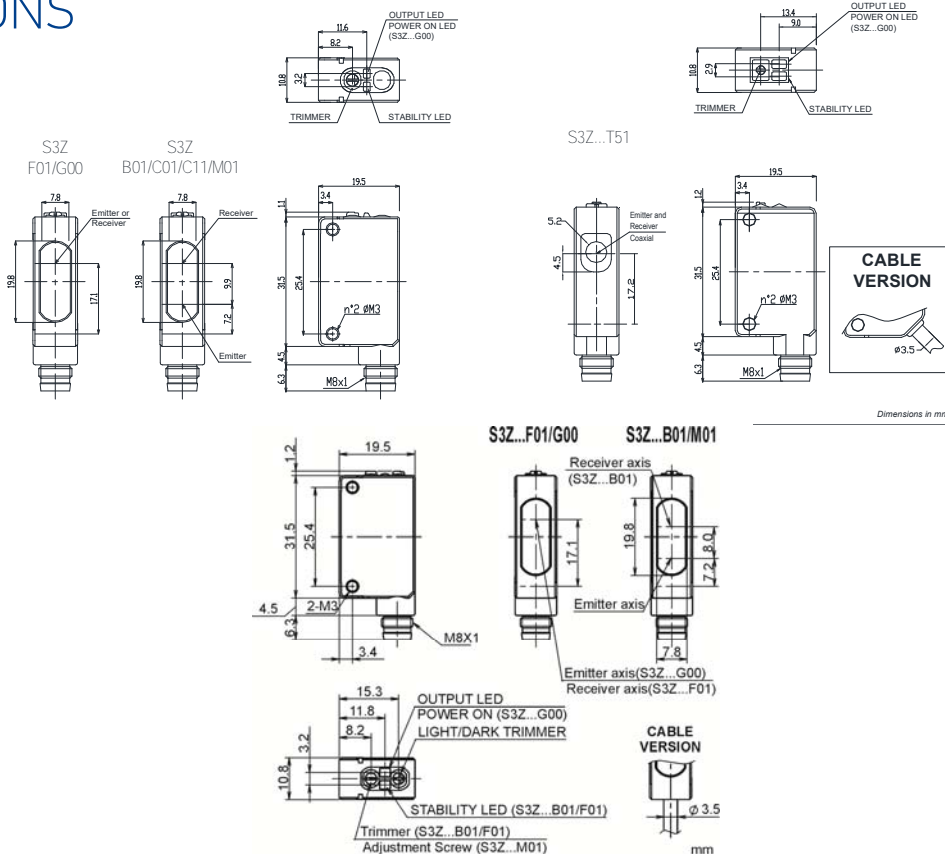

CONNECTIONS

CABLE

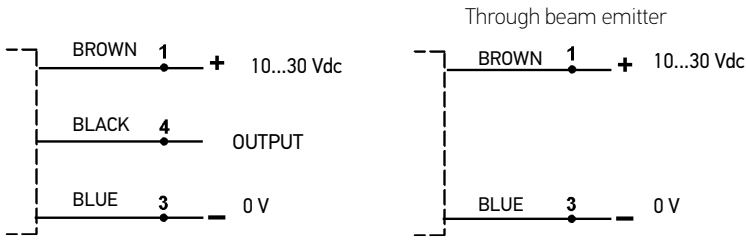

M8 CONNECTOR

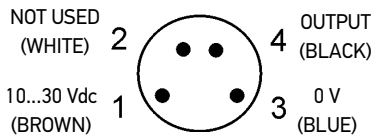

INDICATORS AND SETTINGS

S3Z...F01/G00/B01/C01/M01

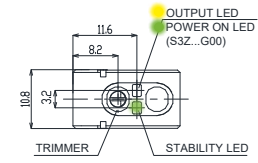

S3Z...T51

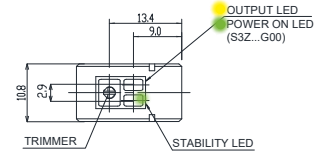

S3Z...F01/G00/B01/M01/S3Z...-PP, -NN

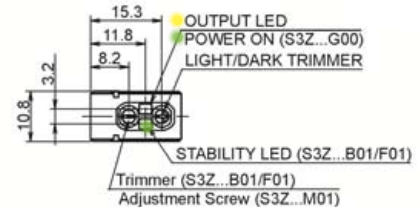
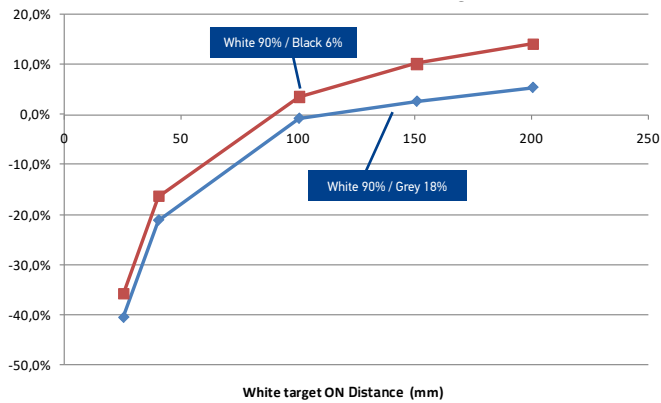
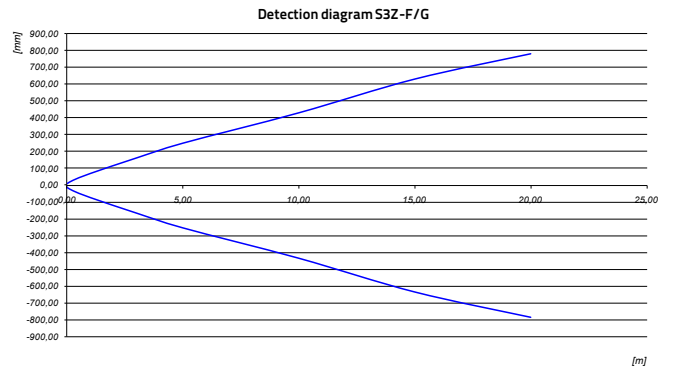

DIAGRAM LED MODELS

BACKGROUND SUPPRESSION - DISTANCE DIFFERENCE VS REFLECTANCE TARGET



THROUGH BEAM - DETECTION AREA



POLARIZED RETROREFLECTIVE - DETECTION AREA

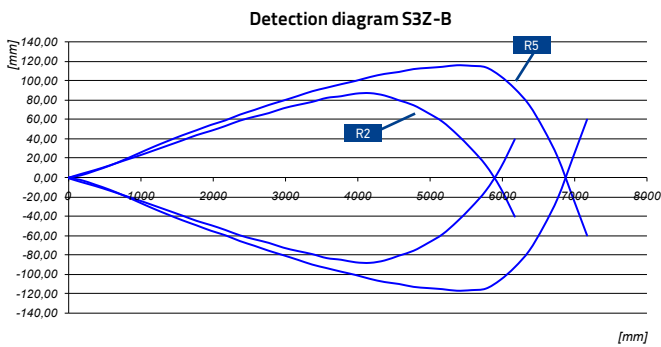

DIFFUSE PROXIMITY - DETECTION AREA

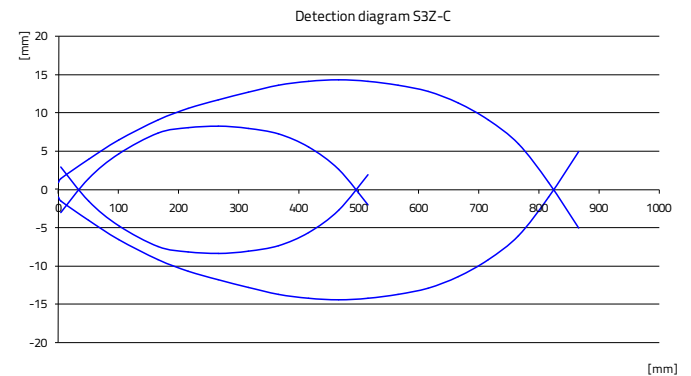

NARROW BEAM PROXIMITY - DETECTION AREA

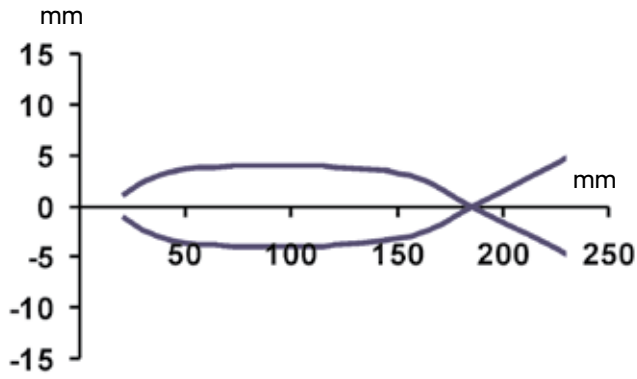

POLARIZED RETROREFLECTIVE FOR TRANSPARENT - DETECTION AREA

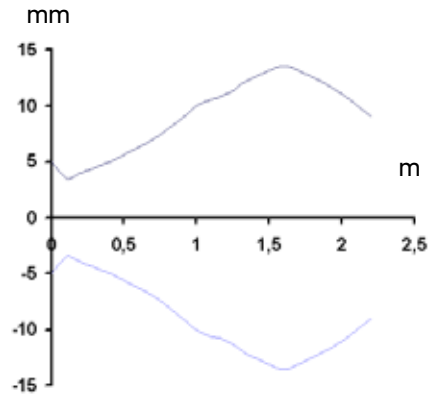

DIAGRAMS LASER MODELS

BACKGROUND SUPPRESSION - DETECTION AREA

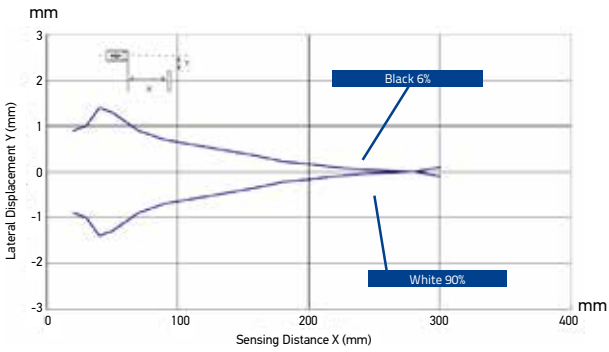

BACKGROUND SUPPRESSION - SPOT DIMENSION

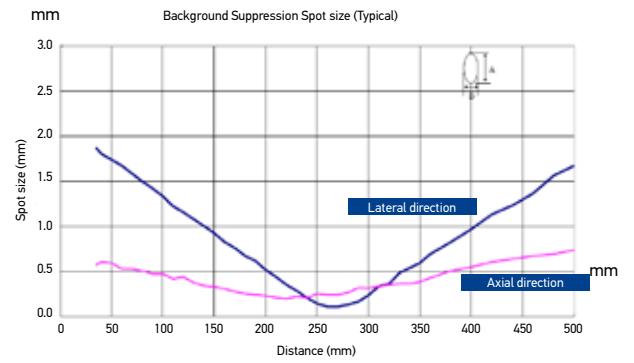

POLARIZED RETROREFLECTIVE - DETECTION AREA

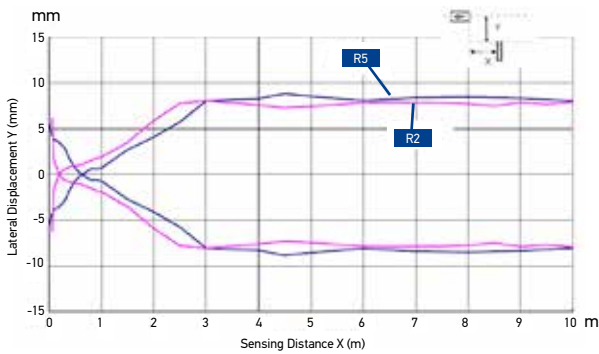

POLARIZED RETROREFLECTIVE - EXCESS GAIN

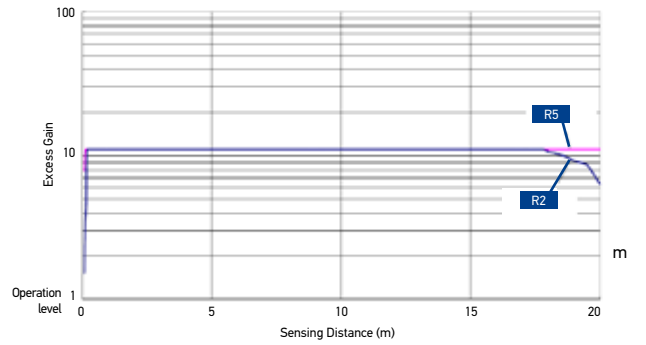

THROUGH BEAM - DETECTION AREA

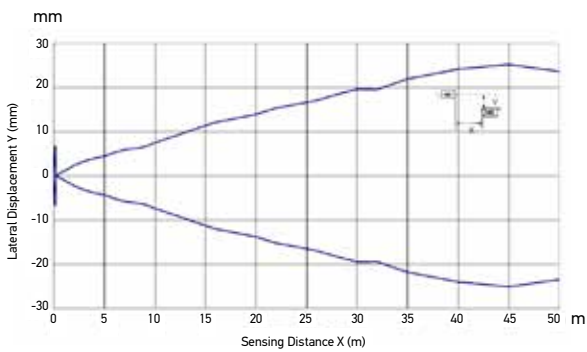

THROUGH BEAM - EXCESS GAIN

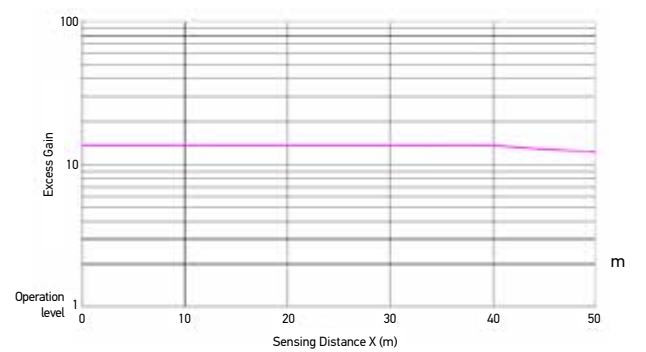

MODEL SELECTION AND ORDER INFORMATION

OPTIC FUNCTION	EMISSION	CONNECTION	OUTPUT	MODEL	ORDER NO.		
Narrow beam diffuse proximity	LED	2 m Cable	PNP - LIGHT	S3Z-PR-2-C01-PL	95B010040		
		M8 Connector	PNP - LIGHT	S3Z-PR-5-C01-PL	95B010050		
		2 m Cable	PNP - DARK	S3Z-PR-2-C01-PD	95B010060		
		M8 Connector	PNP - DARK	S3Z-PR-5-C01-PD	95B010070		
		2 m Cable	NPN - LIGHT	S3Z-PR-2-C01-NL	95B010200		
		M8 Connector	NPN - LIGHT	S3Z-PR-5-C01-NL	95B010210		
		2 m Cable	NPN - DARK	S3Z-PR-2-C01-ND	95B010220		
		M8 Connector	NPN - DARK	S3Z-PR-5-C01-ND	95B010230		
		2 m Cable	PNP - LIGHT/DARK	S3Z-PR-2-C01-PP	95B010670		
		M8 Connector	PNP - LIGHT/DARK	S3Z-PR-5-C01-PP	95B010690		
Long diffuse proximity	LED	2 m Cable	PNP - LIGHT	S3Z-PR-2-C11-PL	95B010001		
		M8 Connector	PNP - LIGHT	S3Z-PR-5-C11-PL	95B010011		
		2 m Cable	PNP - DARK	S3Z-PR-2-C11-PD	95B010021		
		M8 Connector	PNP - DARK	S3Z-PR-5-C11-PD	95B010031		
		2 m Cable	NPN - LIGHT	S3Z-PR-2-C11-NL	95B010161		
		M8 Connector	NPN - LIGHT	S3Z-PR-5-C11-NL	95B010171		
		2 m Cable	NPN - DARK	S3Z-PR-2-C11-ND	95B010181		
		M8 Connector	NPN - DARK	S3Z-PR-5-C11-ND	95B010191		
		2 m Cable	PNP - LIGHT/DARK	S3Z-PR-2-C11-PP	95B010630		
		M8 Connector	PNP - LIGHT/DARK	S3Z-PR-5-C11-PP	95B010650		
Polarized retroreflective	LED	2 m Cable	PNP - LIGHT	S3Z-PR-2-B01-PL	95B010081		
		M8 Connector	PNP - LIGHT	S3Z-PR-5-B01-PL	95B010091		
		2 m Cable	PNP - DARK	S3Z-PR-2-B01-PD	95B010101		
		M8 Connector	PNP - DARK	S3Z-PR-5-B01-PD	95B010111		
		2 m Cable	NPN - LIGHT	S3Z-PR-2-B01-NL	95B010241		
		M8 Connector	NPN - LIGHT	S3Z-PR-5-B01-NL	95B010251		
		2 m Cable	NPN - DARK	S3Z-PR-2-B01-ND	95B010261		
		M8 Connector	NPN - DARK	S3Z-PR-5-B01-ND	95B010271		
		2 m Cable	PNP - LIGHT/DARK	S3Z-PR-2-B01-PP	95B010590		
		M8 Connector	PNP - LIGHT/DARK	S3Z-PR-5-B01-PP	95B010610		
Polarized retroreflective	LASER	2 m Cable	NPN - LIGHT/DARK	S3Z-PR-2-B01-NN	95B010580		
		M8 Connector	NPN - LIGHT/DARK	S3Z-PR-5-B01-NN	95B010600		
		2 m Cable	PNP - LIGHT/DARK	S3Z-PH-2-B01-P	95B010440		
		M8 Connector	PNP - LIGHT/DARK	S3Z-PH-5-B01-P	95B010460		
		2 m Cable	NPN - LIGHT/DARK	S3Z-PH-2-B01-N	95B010450		
		M8 Connector	NPN - LIGHT/DARK	S3Z-PH-5-B01-N	95B010470		
		Through beam	LED	2 m Cable	PNP - LIGHT	S3Z-PR-2-FG01-PL	95B010121
				M8 Connector	PNP - LIGHT	S3Z-PR-5-FG01-PL	95B010131
				2 m Cable	PNP - DARK	S3Z-PR-2-FG01-PD	95B010141
				M8 Connector	PNP - DARK	S3Z-PR-5-FG01-PD	95B010151
2 m Cable	NPN - LIGHT			S3Z-PR-2-FG01-NL	95B010281		
M8 Connector	NPN - LIGHT			S3Z-PR-5-FG01-NL	95B010291		
2 m Cable	NPN - DARK			S3Z-PR-2-FG01-ND	95B010301		
M8 Connector	NPN - DARK			S3Z-PR-5-FG01-ND	95B010311		
2 m Cable	PNP - LIGHT/DARK			S3Z-PR-2-FG01-PP	95B010710		
M8 Connector	PNP - LIGHT/DARK			S3Z-PR-5-FG01-PP	95B010730		
Through beam	LASER	2 m Cable	NPN - LIGHT/DARK	S3Z-PR-2-FG01-NN	95B010700		
		M8 Connector	NPN - LIGHT/DARK	S3Z-PR-5-FG01-NN	95B010720		
		2 m Cable	PNP - LIGHT/DARK	S3Z-PH-2-FG01-P	95B010520		
		M8 Connector	PNP - LIGHT/DARK	S3Z-PH-5-FG01-P	95B010540		
		2 m Cable	NPN - LIGHT/DARK	S3Z-PH-2-FG01-N	95B010530		
		M8 Connector	NPN - LIGHT/DARK	S3Z-PH-5-FG01-N	95B010550		
		Background suPpression	LED	2 m Cable	PNP - LIGHT	S3Z-PR-2-M01-PL	95B010331
				M8 Connector	PNP - LIGHT	S3Z-PR-5-M01-PL	95B010351
				2 m Cable	NPN - LIGHT	S3Z-PR-2-M01-NL	95B010321
				M8 Connector	NPN - LIGHT	S3Z-PR-5-M01-NL	95B010341
2 m Cable	PNP - LIGHT/DARK			S3Z-PR-2-M01-PP	95B010750		
M8 Connector	PNP - LIGHT/DARK			S3Z-PR-5-M01-PP	95B010770		
2 m Cable	NPN - LIGHT/DARK			S3Z-PR-2-M01-NN	95B010740		
M8 Connector	NPN - LIGHT/DARK			S3Z-PR-5-M01-NN	95B010760		
2 m Cable	PNP - LIGHT/DARK			S3Z-PH-2-M01-P	95B010480		
M8 Connector	PNP - LIGHT/DARK			S3Z-PH-5-M01-P	95B010500		
Polarized retroreflective for transparent	LED	2 m Cable	NPN - LIGHT/DARK	S3Z-PH-2-M01-N	95B010490		
		M8 Connector	NPN - LIGHT/DARK	S3Z-PH-5-M01-N	95B010510		
		2 m Cable	NPN - DARK	S3Z-PR-2-T51-ND	95B010390		
		2 m Cable	PNP - DARK	S3Z-PR-2-T51-PD	95B010380		
		M8 Connector	NPN - DARK	S3Z-PR-5-T51-ND	95B010370		
		M8 Connector	PNP - DARK	S3Z-PR-5-T51-PD	95B010360		

S45



HIGH PERFORMANCE EUROPEAN STYLE MINIATURE SENSOR ALL-IN-ONE FAMILY



- Red LED and Laser emissions
- Precise risk free laser class 1 emission
- Diffused LED proximity 800mm
- Background Suppression 400mm
- Retroreflective Class 1 Laser 15m/Red LED 7m
- Through beam Class 1 Laser 20m/Red LED 15m
- IP69K housing
- 2m Cable or metal M8 4 pole version
- PNP or NPN output with remote teach in input
- High speed RGB and white emission contrast sensor
- High precision distance sensor up to 200 mm



APPLICATIONS

- Processing and Packaging machinery
- Cosmetic and Pharmaceutical industry
- Electronics assembling
- Conveyor lines, material handling
- Automotive industry
- Print and paper industry
- Small part detection with maximum accuracy

S45		
Through beam	20m. (Laser Class1) 15m. (Red Led)	
Polarized Retroreflective	15m. (Laser Class1) 7m. (Red Led)	
Autocollimated Retroreflective for Transparent objects	2m. (Red Led)	
Autocollimated Retroreflective	2m. (Red Led)	
Diffused proximity	250mm. (Laser Class1) 800mm. (Red Led)	
Background suppressor	120mm. (Laser Class 1) 200mm. (Red Led) 400mm. (Red Led)	
Distance sensor	80mm. (Red Led) 200mm. (Red Led)	
Contrast Sensor	12mm. (White) 12mm. (RGB)	
Power Supply	Vdc	10...30Vdc
	Vac	(13...30Vdc Y models)
	Vac/Vdc	
Output	PNP	•
	NPN	•
	NPN/PNP	
	relay	
	other	Push Pull (Wxx, Yxx), Analog 0...10 V (Yxx)
Connection	cable	•
	connector	•
	pig-tail	
Approximate dimensions (mm)	34mm. x 20mm. X 12mm.	
Housing material	ABS(Housing), PMMA (Optics)	
Mechanical protection	IP67 & IP69K	

TECHNICAL DATA

Power supply	10...30Vdc (13...30Vdc Y models)
Ripple	10% max.
Consumption (Load current excluded)	≤ 30 mA
Light emission	Red LED 632 nm, Red Laser 650 nm
Setting	Push Button TEACH-IN
Indicators	LED Green Operating Volatage LED Yellow Output Status
Output	NPN, PNP, Push Pull (Wxx, Yxx), Analog 0...10 V (Yxx)
Output current	100 mA
Saturation voltage	2 V max
Response time	500 μs 333 μs (C03 Laser) 250 μs (F/G Laser) 50 μs (W03, W33) 20 μs (W13, W43)
Switching frequency	≤ 1000Hz ≤ 1500Hz (C03 Laser) ≤ 2000 Hz (F/G Laser) ≤ 10 kHz (W03, W33) ≤ 25 kHz (W13, W43)
Connection	Plastic M8 4-pole connector, Metal M8 4-pole connector 2 m cable
Dielectric strength	500 Vac, 1min between electronic and housing
Insulating resistance	>20M OHM, 500 Vdc between electronic and housing
Electrical protection	class 2
Mechanical protection	IP67 & IP69K
Ambient light rejection	according to EN 60947-5-2
Vibrations	0,5mm amplitude, 10...55Hz frequency , for every axis (EN60068-2-6)
Shock resistance	11 ms (30G) 6 shock for every axis (EN60068-2-27)
Housing material	ABS
Lens material	PMMA
Operating temperature	-20...+60 °C
Storage temperature	-20...+80 °C
Weight	10g. with connector, 40g. with cable

DIMENSIONS

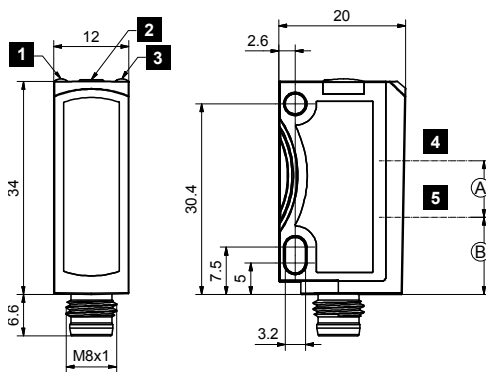

	S45-PR-2(5)-M03 S45-PR-5-Y03	S45-PR-2(5)-M13 S45-PR-5-Y13	S45-PR-2(5)-C03 S45-PR-B03	S45-PH-5-M03	S45-PH-5-C03 S45-PH-B03	S45-PR-G00	S45-PH-G00	S45-PR(PH)-F03
A	9	11.75	10.8	8.8	8.8	11.5	13.5	
B	12.3	11	11.5	12.5	13.5			22.3

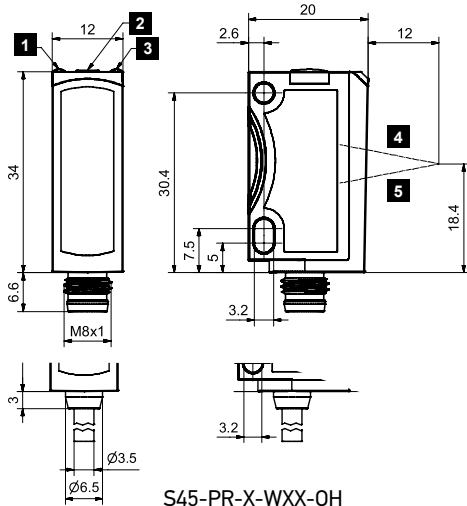

S45-PR-X-WXX-OH

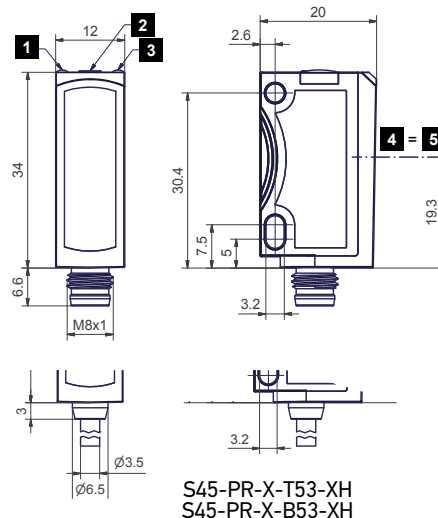

S45-PR-X-T53-XH
S45-PR-X-B53-XH

1	Yellow LED 1)
2	Button
3	Green LED 2)
4	Receiver axis
5	Emitter axis

1) switching output indicator
2) operating voltage indicator

CONNECTIONS

CABLE

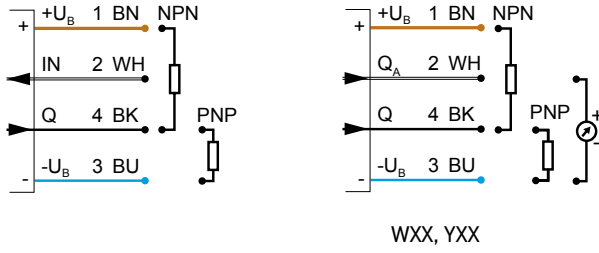

M8 CONNECTOR

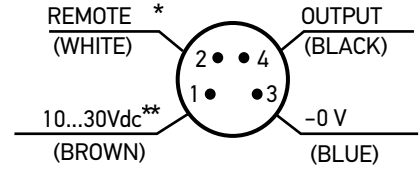

* Analog out YXX

** 13...30Vdc Y models

INDICATORS AND SETTINGS

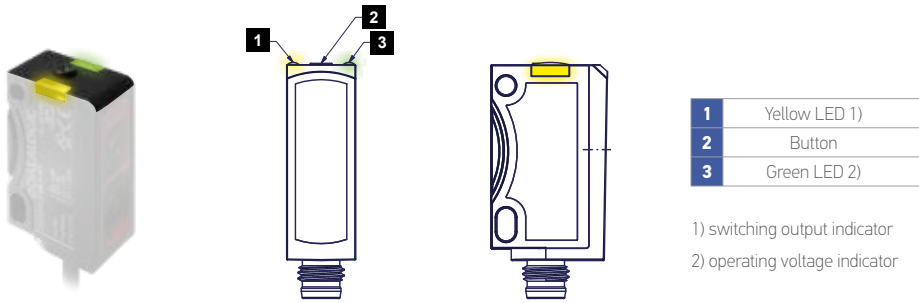

DETECTION DIAGRAMS

BACKGROUND SUPPRESSOR

DETECTION SPOT SIZE

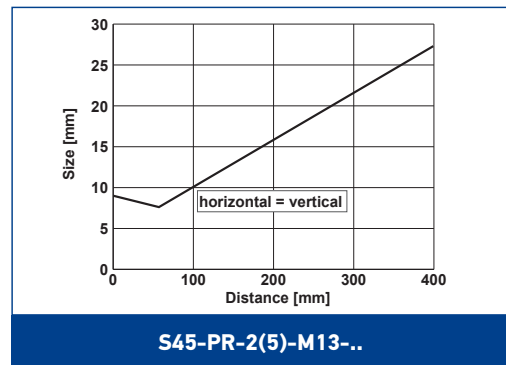
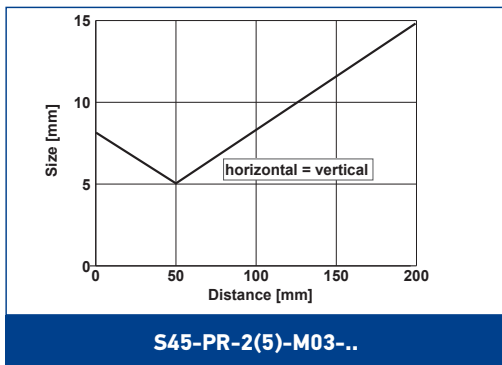

B/W SHIFT

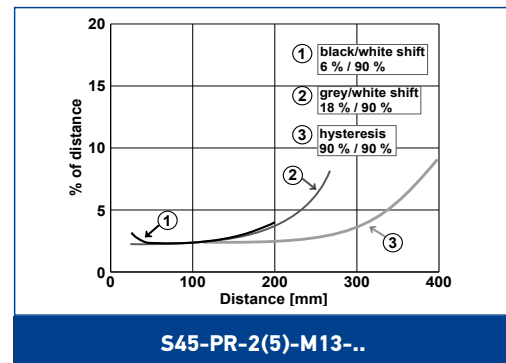
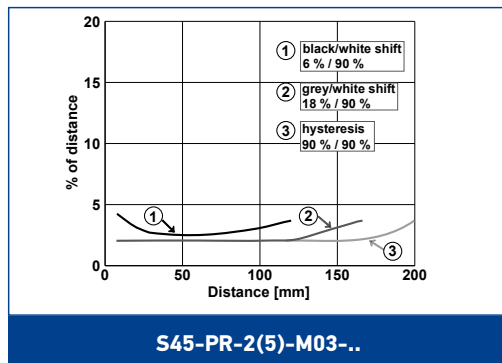

ENERGETIC DIFFUSED

DETECTION SPOT SIZE

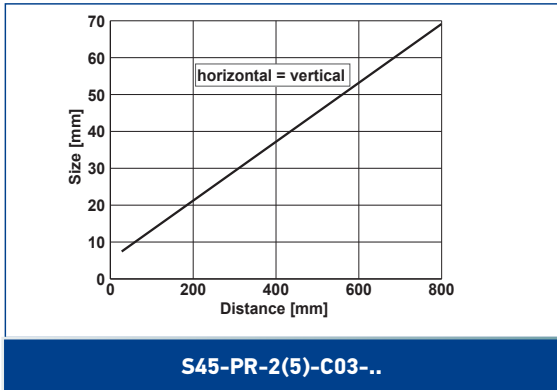

EXCESS GAIN

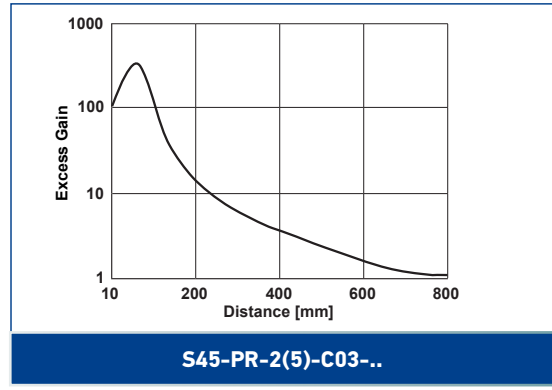

RETROREFLECTIVE POLARIZED

DETECTION SPOT SIZE

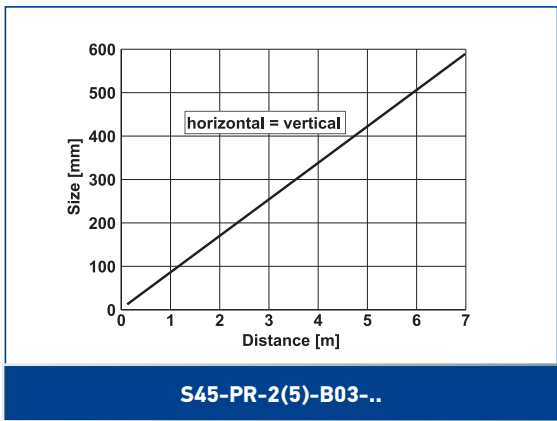

EXCESS GAIN

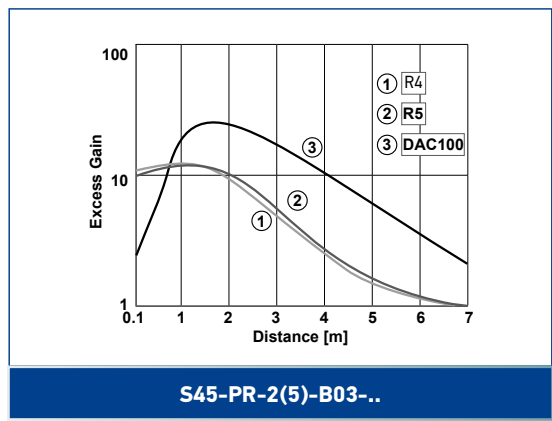

COAXIAL RETROREFLECTIVE POLARIZED

DETECTION SPOT SIZE

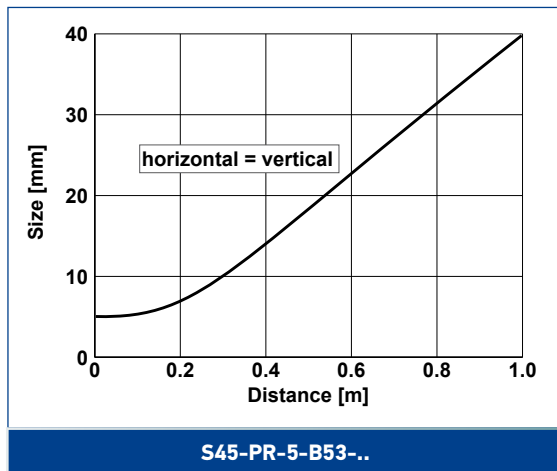

RETROREFLECTIVE FOR TRANSPARENT

DETECTION SPOT SIZE

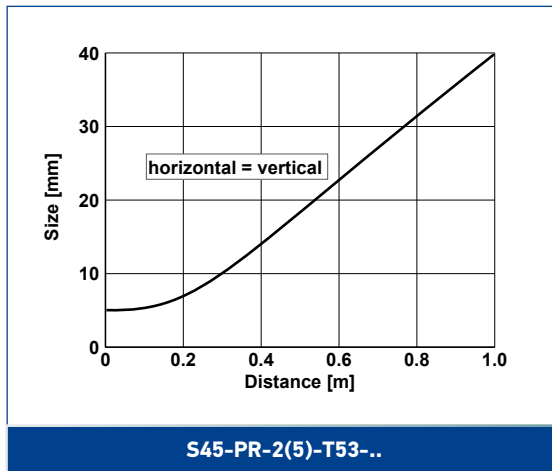

THROUGH BEAM

DETECTION SPOT SIZE

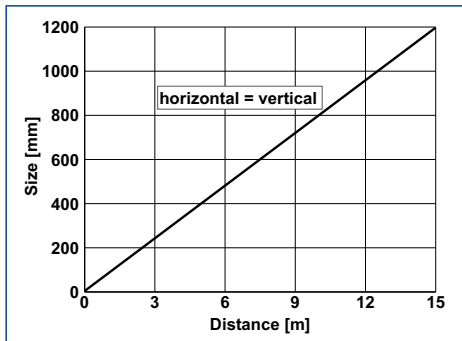

S45-PR-2(5)-F03-../S45-PR-2(5)-G00-XE

EXCESS GAIN

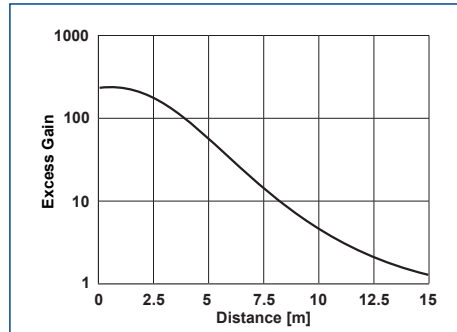

S45-PR-2(5)-F03-../S45-PR-2(5)-G00-XE

LASER BACKGROUND SUPPRESSOR

DETECTION SPOT SIZE

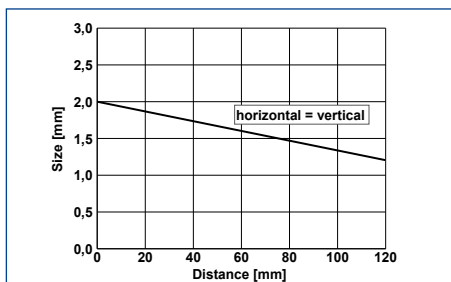

S45-PH-5-M03-..

B/W SHIFT

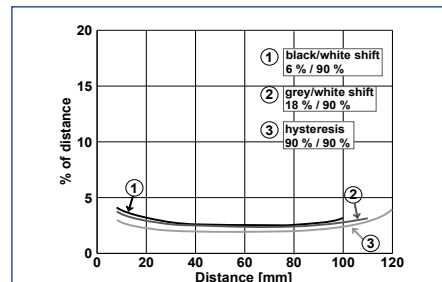

S45-PH-5-M03-..

LASER ENERGETIC DIFFUSED

DETECTION SPOT SIZE

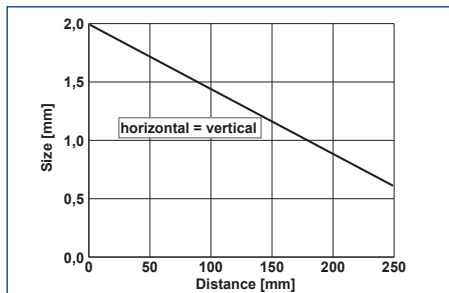

S45-PH-5-C03-..

EXCESS GAIN

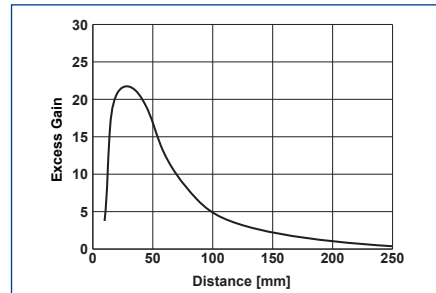

S45-PH-5-C03-..

LASER RETROREFLECTIVE POLARIZED

DETECTION SPOT SIZE

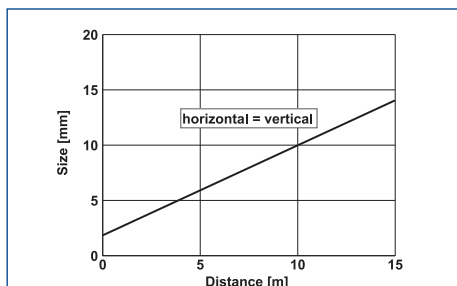

S45-PH-5-B03-..

EXCESS GAIN

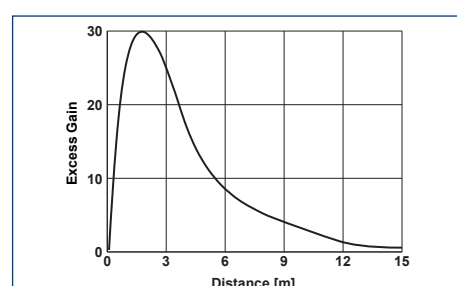

S45-PH-5-B03-..

LASER THROUGH BEAM

DETECTION SPOT SIZE

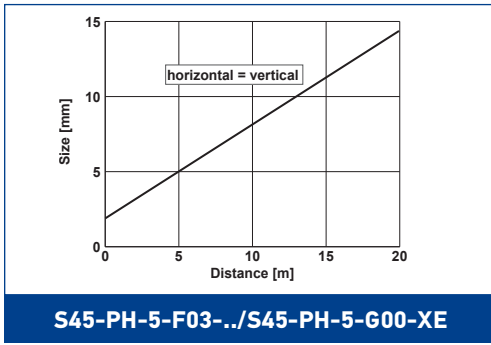

EXCESS GAIN

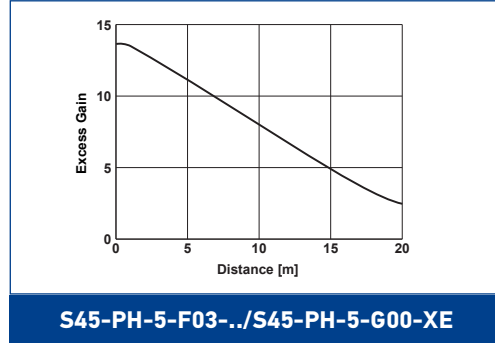

CONTRAST SENSOR

READING DIAGRAM

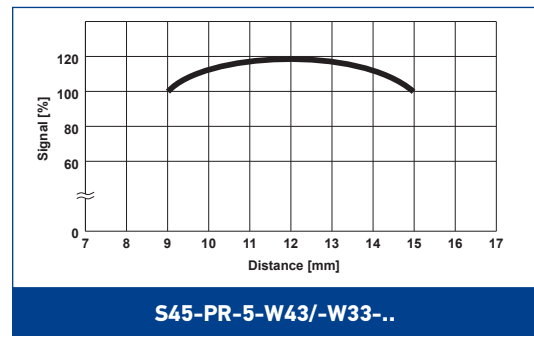
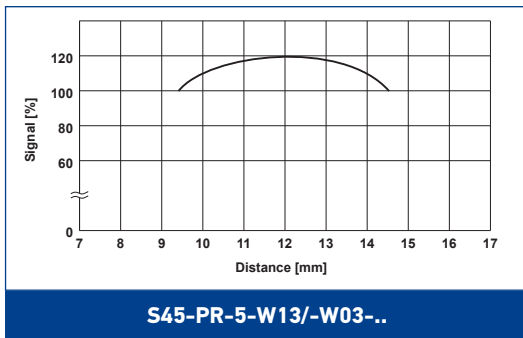

DISTANCE SENSOR

DETECTION SPOT SIZE

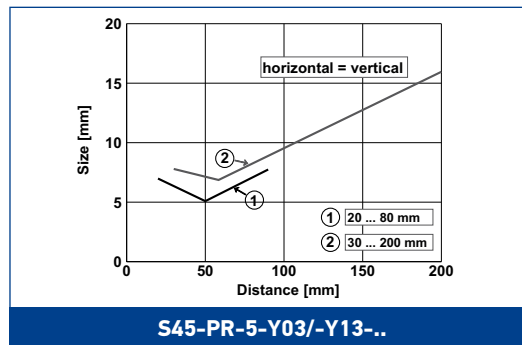

READING DIAGRAM

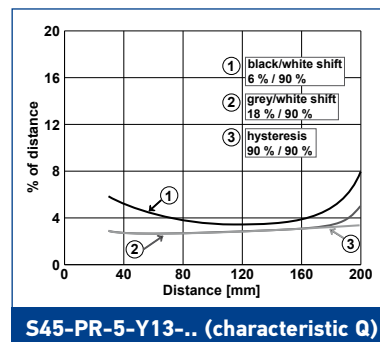
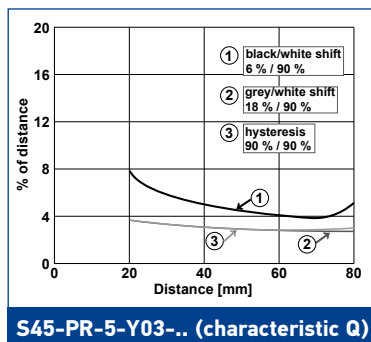

MODEL SELECTION AND ORDER INFORMATION

OPTIC FUNCTION	EMISSION	CONNECTION	OUTPUT	MODEL	ORDER NO.
Diffused proximity	LED	2m Cable	PNP	S45-PR-2-C03-PH	950411220
			NPN	S45-PR-2-C03-NH	950411210
		M8	PNP	S45-PR-5-C03-PH	950411240
			NPN	S45-PR-5-C03-NH	950411230
	LASER	M8	PNP	S45-PH-5-C03-PH	950411260
			NPN	S45-PH-5-C03-NH	950411250
Polarized Retroreflective	LED	2m Cable	PNP	S45-PR-2-B03-PH	950411100
			NPN	S45-PR-2-B03-NH	950411090
		M8	PNP	S45-PR-5-B03-PH	950411120
			NPN	S45-PR-5-B03-NH	950411110
	LASER	M8	PNP	S45-PH-5-B03-PH	950411140
			NPN	S45-PH-5-B03-NH	950411130
Polarized retroreflective autocollimated for transparent	LED	2m Cable	PNP	S45-PR-2-T53-PH	950411160
			NPN	S45-PR-2-T53-NH	950411150
		M8	PNP	S45-PR-5-T53-PH	950411180
			NPN	S45-PR-5-T53-NH	950411170
Polarized retroreflective autocollimated	LED	M8	PNP	S45-PR-5-B53-PH	950411200
			NPN	S45-PR-5-B53-NH	950411190
Through beam	LED	2m Cable	-	S45-PR-2-G00-XE	950411000
			PNP	S45-PR-2-F03-PH	950411020
			NPN	S45-PR-2-F03-NH	950411010
		M8	-	S45-PR-5-G00-XE	950411030
			PNP	S45-PR-5-F03-PH	950411050
			NPN	S45-PR-5-F03-NH	950411040
	LASER	M8	-	S45-PH-5-G00-XE	950411060
			PNP	S45-PH-5-F03-PH	950411080
			NPN	S45-PH-5-F03-NH	950411070
Background suppressor 200mm	LED	2m Cable	PNP	S45-PR-2-M03-PH	950411280
			NPN	S45-PR-2-M03-NH	950411270
		M8	PNP	S45-PR-5-M03-PH	950411300
			NPN	S45-PR-5-M03-NH	950411290
Background suppressor 400mm	LED	2m Cable	PNP	S45-PR-2-M13-PH	950411320
			NPN	S45-PR-2-M13-NH	950411310
		M8	PNP	S45-PR-5-M13-PH	950411340
			NPN	S45-PR-5-M13-NH	950411330
Background suppressor laser	LASER	M8	PNP	S45-PH-5-M03-PH	950411360
			NPN	S45-PH-5-M03-NH	950411350
Distance sensor	LED	M8	PNP	S45-PR-5-Y03-PV	950411380
			NPN	S45-PR-5-Y03-NV	950411370
Distance sensor	LED	M8	PNP	S45-PR-5-Y13-PV	950411400
			NPN	S45-PR-5-Y13-NV	950411390
Contrast Sensor 10kHz	WHITE	M8	PUSH-PULL	S45-PR-5-W03-OH	950411420
	RGB		PUSH-PULL	S45-PR-5-W13-OH	950411410
Contrast Sensor 25kHz	WHITE	M8	PUSH-PULL	S45-PR-5-W33-OH	950411440
	RGB		PUSH-PULL	S45-PR-5-W43-OH	950411430

ACCESSORIES

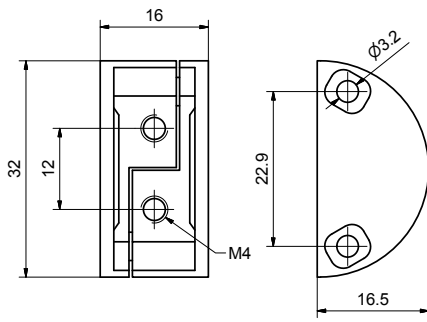

ST-S45-DVT

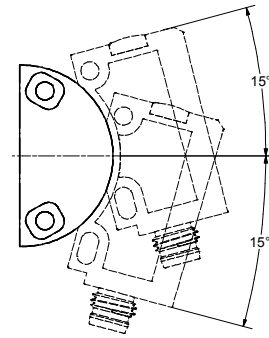

ST-S45-DVT

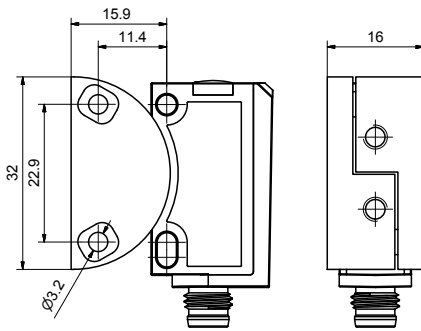

ST-S45-DVT

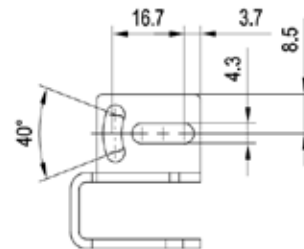
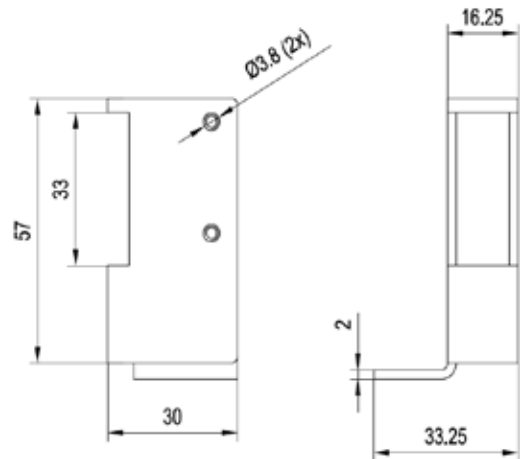

ST-MINI-PRO

MODEL	DESCRIPTION	ORDER NO.
ST-S45-DVT	S45 DOVE TAIL BRACKET	95ACC7970
ST-MINI-PRO	MINI PROTECTIVE BRACKET	95ACC7980

CABLES

TYPE	DESCRIPTION	LENGTH	MODEL	ORDER No.
Axial M8 Connector	4-pole, grey, P.V.C.	3 m	CS-B1-02-G-03	95A251420
		5 m	CS-B1-02-G-05	95A251430
		7 m	CS-B1-02-G-07	95A251440
		10 m	CS-B1-02-G-10	95A251480
	4-pole, P.U.R.	2 m	CS-B1-02-R-02	95A251620
		5 m	CS-B1-02-R-05	95A251640
Radial M8 Connector	4-pole, grey, P.V.C.	3 m	CS-B2-02-G-03	95A251450
		5 m	CS-B2-02-G-05	95A251460
		7 m	CS-B2-02-G-07	95A251470
		10 m	CS-B2-02-G-10	95A251530
	4-pole, P.U.R.	2 m	CS-B2-02-R-02	95A251630
		5 m	CS-B2-02-R-05	95A251650

S5N

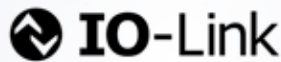

EXTENDED RANGE OF STANDARD “ONE FOR ALL” PHOTOELECTRIC TUBULAR M18 SENSORS

- All optic functions
- Improved EMI immunity
- Improved ambient light immunity
- Improved laser safety level
- M18 flat plastic with universal mounting
- Available in M18 metal housing
- Axial or radial optics, cable or connector
- Standard 4-wire NO-NC NPN or PNP output
- IO-Link connectivity V1.1 with double channel



APPLICATIONS

- Processing and Packaging machinery
- Conveyor lines, material handling
- Ceramics intralogistics
- Automated warehousing

S5N

Through beam	0...25 m	
	0...60 m (class 1 LASER)	
Retroreflective (on R2 reflector)	0,1...4 m	
Polarized retroreflective	0,1...4 m	
	0,1...16 m (class 1 LASER)	
Retroreflective for transparent (on R2 reflector)	0,1...1,3 m	
Diffuse proximity	short distance 0...100 mm	
	medium distance 0...400 mm	
	long distance 0...700 mm	
	long distance LASER 0...350 mm	
Fixed focus	100 mm	
Background suppression	50...150 mm	
Through beam with fiber optic	0...100 mm	
Diffuse proximity with fiber optic	0...30 mm	
Contrast sensor	10 ±2 mm	
Luminescence sensor	0...20 mm	
Power supply	Vdc	10...30 V
	Vac	
	Vac/dc	
Output	PNP	•
	NPN	•
	NPN/PNP	
	relay	
	other	IO-Link v 1.1
Connection	cable	•
	connector	•
	pig-tail	
Approximate dimensions (mm)	M18x 55/68	
Housing material	PBT, nickel plated brass	
Mechanical protection	IP67	

TECHNICAL DATA

Power supply	10 ... 30 Vdc (limit values)
Ripple	2 Vpp max.
Consumption (output current excluded)	35 mA max. (mod. S5N...A00/B01/C01/C10/C21/D00/E01/T01)
	30 mA max. (mod. S5N...F01/M03)
	25 mA max. (mod. S5N...W03/U03)
Light emission	red LED 630 nm (mod. S5N...D00/E01, S5N-PA/MA...M03)
	red LED 660 nm (mod. S5N...B01/T01)
	red LED 670 nm (mod. S5N-PS/MS...M03)
	IR LED 880 nm (mod. S5N...A00/C01/C10/C21/G00)
	white LED 400-700 nm (mod. S5N...W03)
	UV LED 370 nm (mod. S5N...U03)
	red Laser 650 nm (mod. S5N...G00/F01/B01/C01)
Setting	sensitivity trimmer (mod. B01/C01/C21/E01/F01/T01)
	teach-in push-button (mod. M03/W03/U03)
Operating mode	LIGHT mode on N.O. output / DARK mode on N.C. output (mod.S5N...C01/C10/C21/D00/M03/U03)
	DARK mode on N.O. output / LIGHT mode on N.C. output (mod.S5N...A00/B01/E01/F01/T01/W03)
Indicators	yellow OUTPUT LED (S5N, excl. mod. G00)
	green STABILITY LED (mod. S5N...B01/C01/C21/E01/F01), POWER LED (mod. S5N...G00)
	green/red READY/ERROR LED (mod. S5N...M03/W03/U03)
Output	PNP or NPN; NO; NC (mod. S5N) IO-Link v 1.1 (mod.S5N...OZ)
IO-Link interface	(mod.S5N...OZ) v 1.1, com 2, 38,4 kBaud, 32 bit process data, 5 ms cycle time LED emission model, 8 ms cycle time LASER emission model
Output current	100 mA max.
Saturation voltage	2 V max.
Response time	0,5 ms (mod. S5N...A00/B01/T01/C10/C21/C01/D00/E01/U03)
	2 ms (mod. S5N...F01/G00)
	1 ms (mod. S5N...M03)
	100 µs (mod. S5N...W03)
	333 µs (Laser mod. S5N)
Switching frequency	1 kHz (mod. S5N...A00/B01/T01/C10/C21/C01/D00/E01/U03)
	250 Hz (mod. S5N...F01/G00)
	500 Hz (mod. S5N...M03)
	5 kHz (mod. S5N...W03)
	1,5 kHz (Laser mod. S5N)
Connection	2 m cable Ø- 4 mm, M12 4-pole connector
Dielectric strength	500 Vac, 1 min between electronics and housing
Insulating resistance	>20 MΩ, 500 Vdc between electronics and housing
Electrical protection	class 2
Mechanical protection	IP67
Ambient light rejection	according to EN 60947-5-2
Vibrations	0,5 mm amplitude, 10 ... 55 Hz frequency, for every axis (EN60068-2-6)
Shock resistance	11 ms (30 G) 6 shock for every axis (EN60068-2-27)
Housing material	Plastic version PBT
	Metal version nickel plated brass
Lens material	PMMA
Operating temperature	-25 ... 55 °C
	(Laser mod.) -10 ... 50 °C
Storage temperature	-25 ... 70 °C
Weight	Plastic version 75 g max. cable vers. (90 g max. mod. M03), 25 g max. conn. vers. (40 g max. mod. M03)
	Metal version 110 g max. cable vers. (125 g max. mod. M03), 60 g max. conn. vers. (75 g max. mod. M03)

DIMENSIONS

PLASTIC

AXIAL VERSION

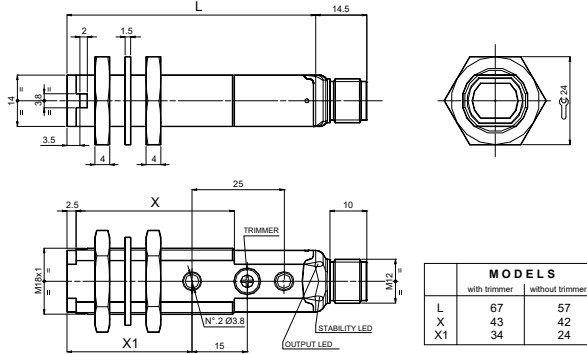

RADIAL VERSION

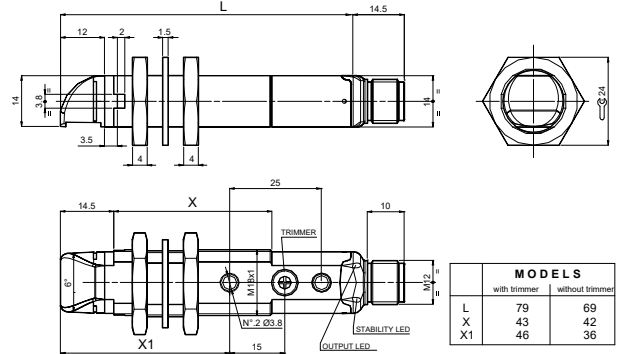

FIBRE OPTIC VERSION

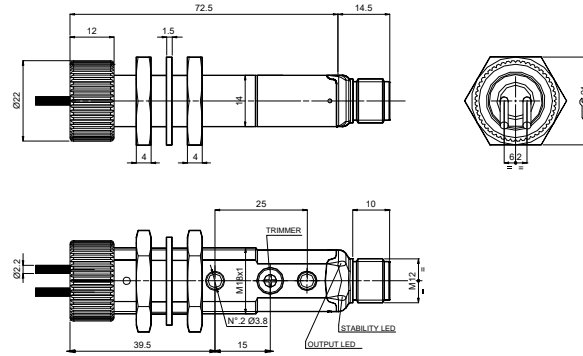

METAL

AXIAL VERSION

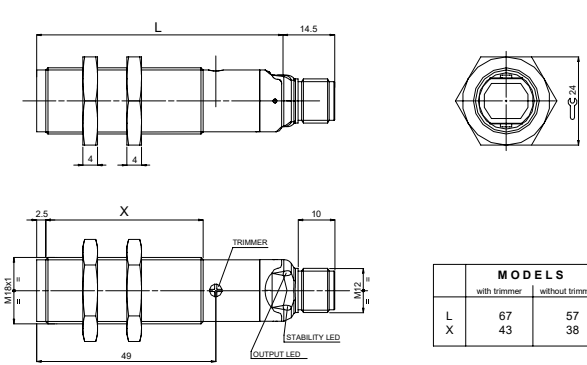

RADIAL VERSION

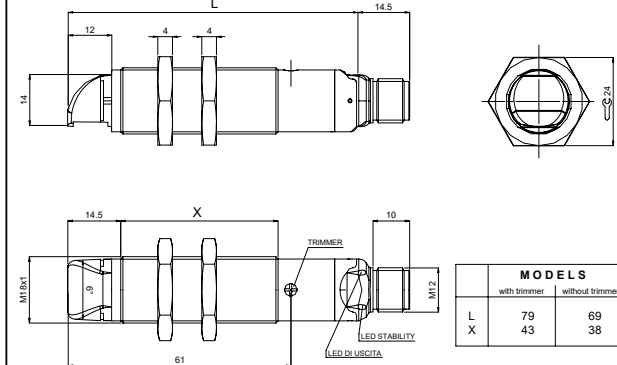

FIBRE OPTIC VERSION

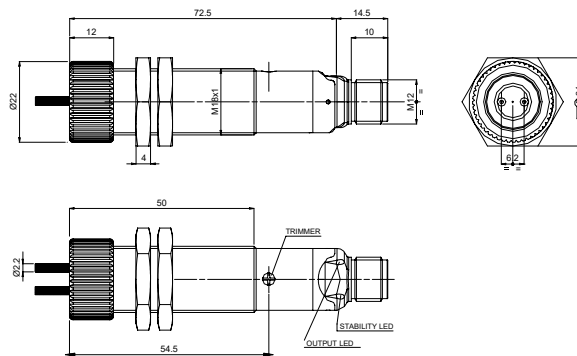

CONNECTIONS

CABLE

Through beam emitter

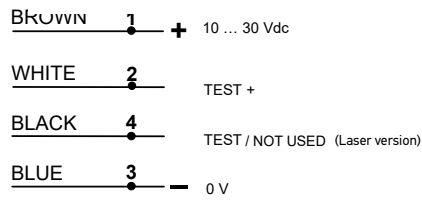
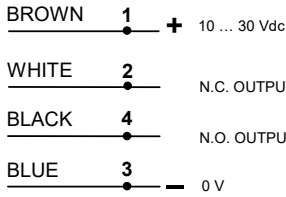

M12 CONNECTOR

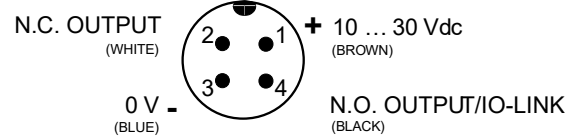
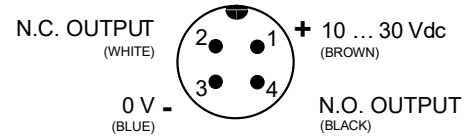

INDICATORS AND SETTINGS

S5N-XX...A00/B01/C01/C21/E01/F01/T01



- A** OUTPUT status LED Yellow
STABILITY LED Green (Only Receiver)
POWER ON LED Green (Only Emitter)
- B** Adjustment trimmer (receiver)

Single-turn trimmer for sensitivity adjustment. Rotate in a clockwise direction to increase the operating distance.

S5N-XX-U03

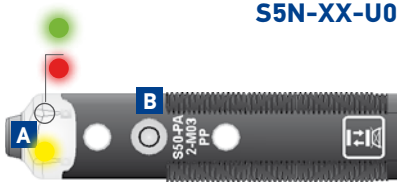

- A** OUTPUT status LED Yellow
READY LED Green
LED Red error
- B** Teach-in push-button

S5N-XX-M03/W03



- A** OUTPUT status LED Yellow
READY LED Green
- B** Teach-in push-button

Teach-in button for setting. EASYtouch™ provides two setting modes: standard or fine, both obtained by pressing the push-button only once. Please refer to instructions manual for operating details.

S5N-XX-A00/C10/D00



- A00/C10
- A** OUTPUT status LED Yellow

G00
OUTPUT status LED yellow (Only Emitter G00)

S5N DETECTION DIAGRAMS

THROUGH BEAM (G/F) INFRARED EMISSION

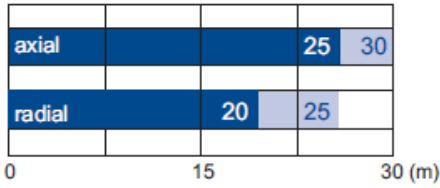

■ Recommended operating distance
 ■ Maximum operating distance

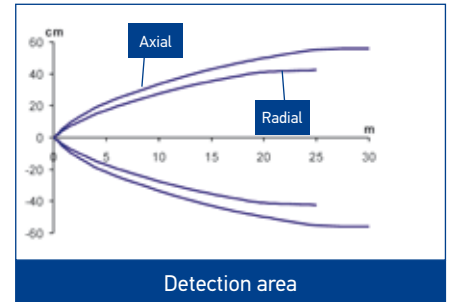
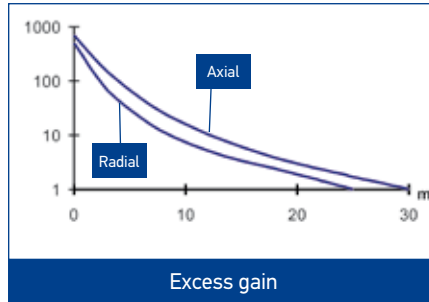

THROUGH BEAM (G/F) LASER RED EMISSION

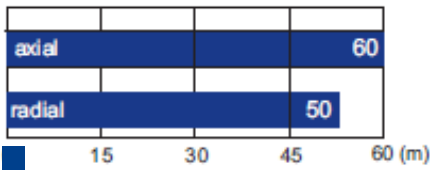

Operating distance

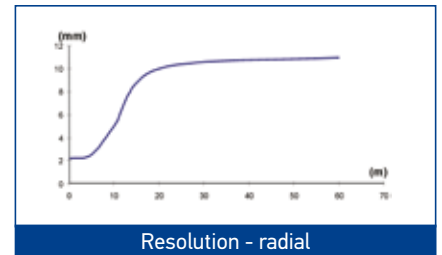
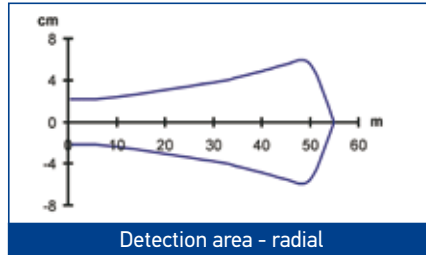
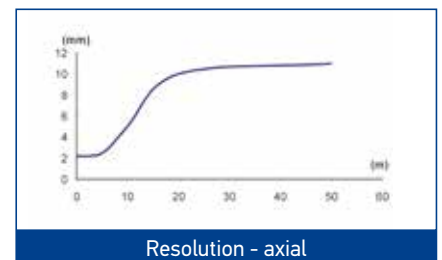
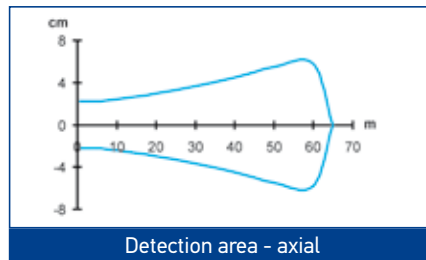

RETROREFLECTIVE (A) INFRARED EMISSION



■ Operating distance

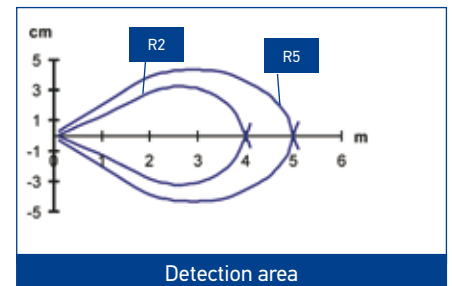
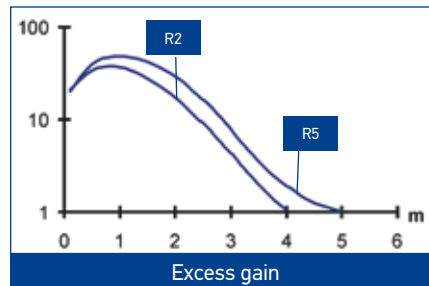

RETROREFLECTIVE POLARIZED (B) RED EMISSION

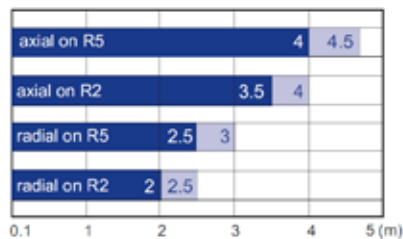

■ Recommended operating distance
 ■ Maximum operating distance

High efficiency reflectors can be used to obtain larger operating distances. Refer to **Reflectors** (A.01).

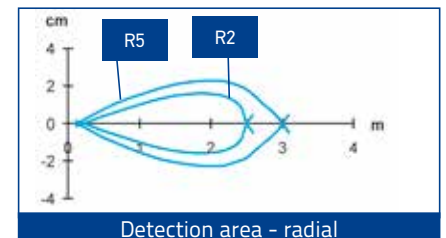
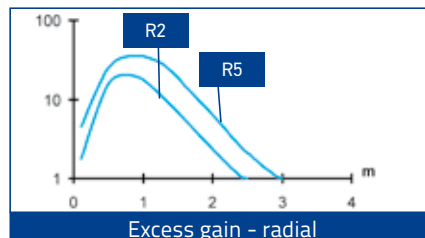
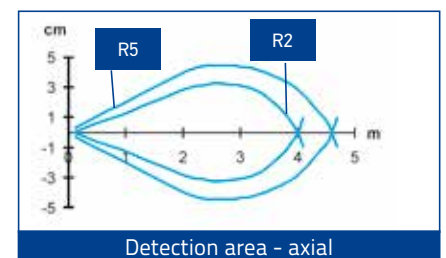
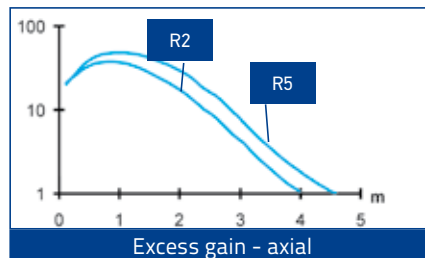

RETROREFLECTIVE POLARIZED (B) LASER RED EMISSION

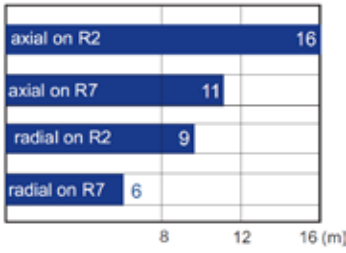

■ Operating distance

High efficiency reflectors can be used to obtain larger operating distances. Refer to **Reflectors** (A.01).

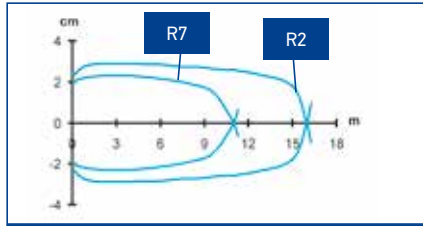

Detection area - axial

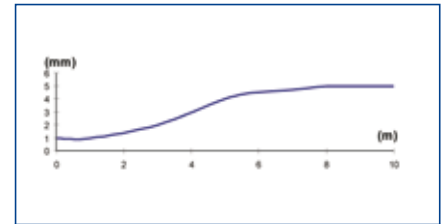

Resolution on R7 reflector - axial

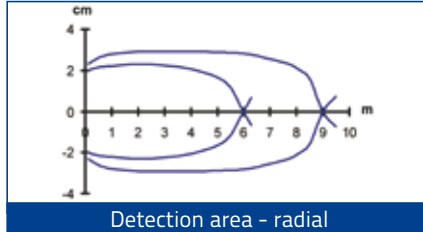

Detection area - radial

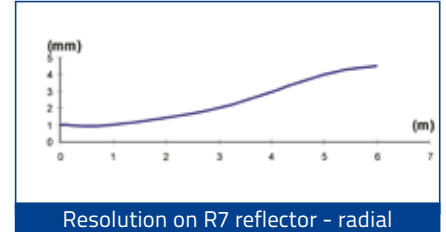

Resolution on R7 reflector - radial

RETROREFLECTIVE TRANSPARENT (T) RED EMISSION

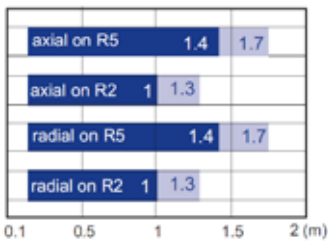

■ Recommended operating distance
 ■ Maximum operating distance

High efficiency reflectors can be used to obtain larger operating distances. Refer to **Reflectors**.

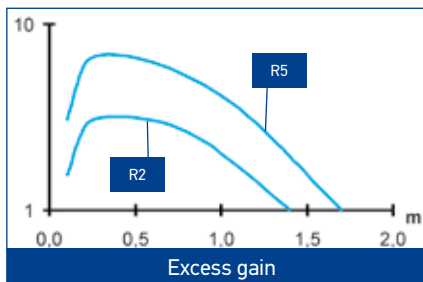

Excess gain

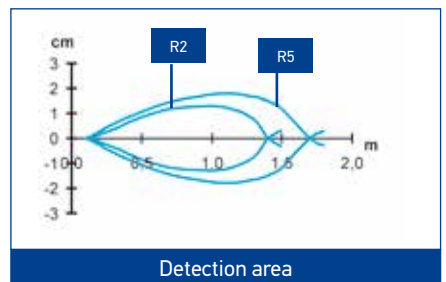

Detection area

ENERGETIC DIFFUSED (C) SHORT INFRARED EMISSION

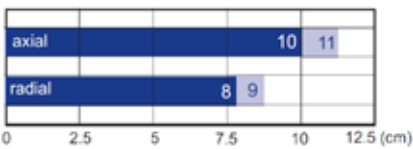

■ Recommended operating distance
 ■ Maximum operating distance

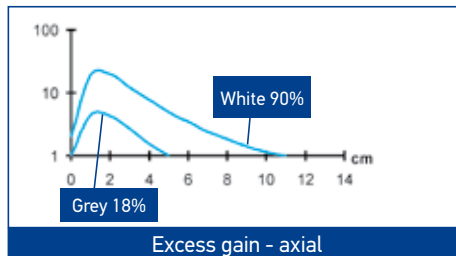

Excess gain - axial

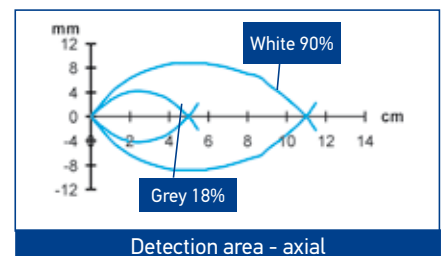

Detection area - axial

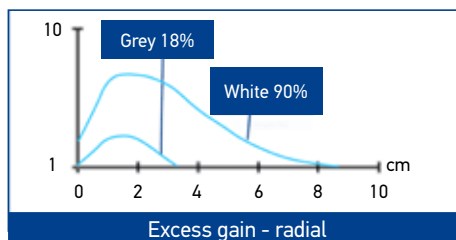

Excess gain - radial

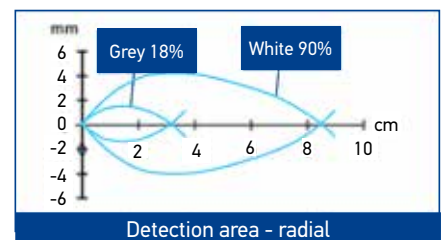

Detection area - radial

ENERGETIC DIFFUSED (C) MID INFRARED EMISSION

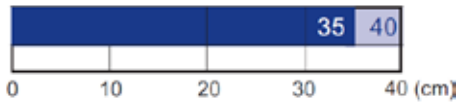

Recommended operating distance
 Maximum operating distance

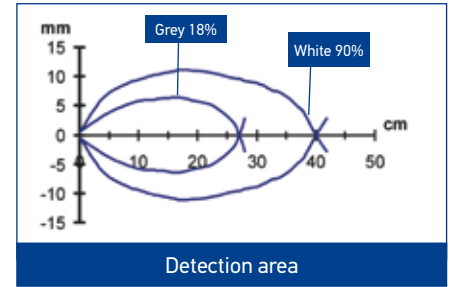
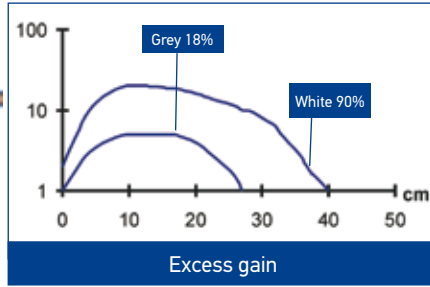

ENERGETIC DIFFUSED (C) LONG INFRARED EMISSION

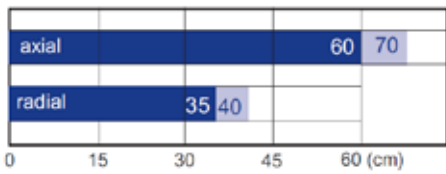

Recommended operating distance
 Maximum operating distance

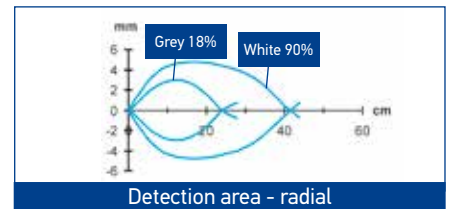
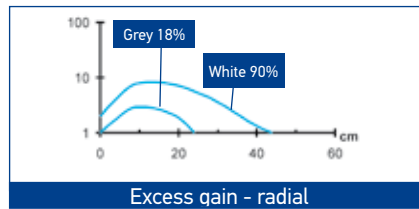
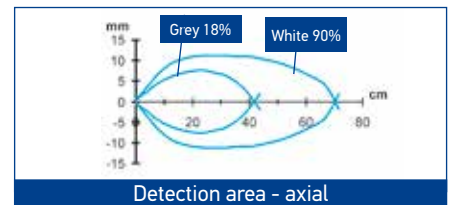
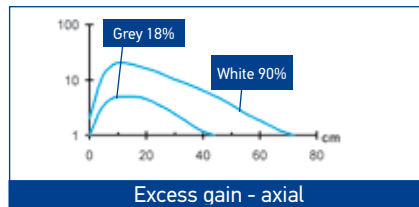

FIXED FOCUS (D) RED EMISSION

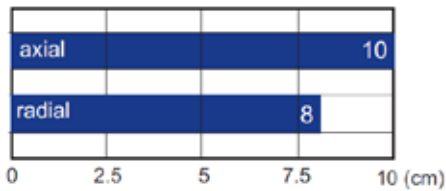

Operating distance

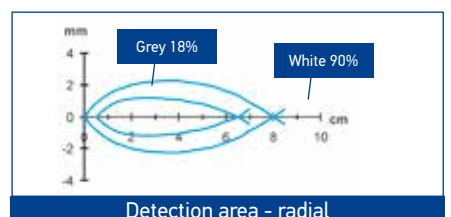
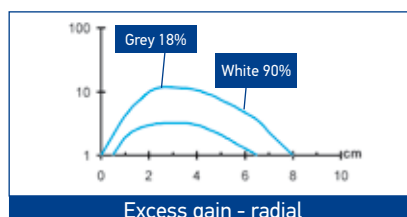
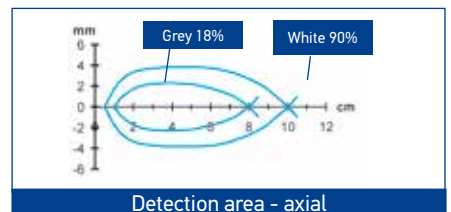
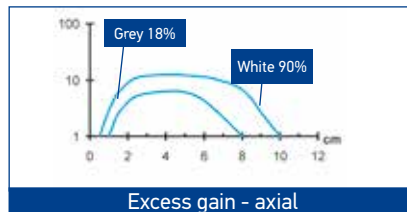

DIFFUSED (C) LASER RED EMISSION

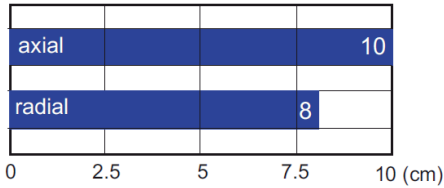

Operating distance

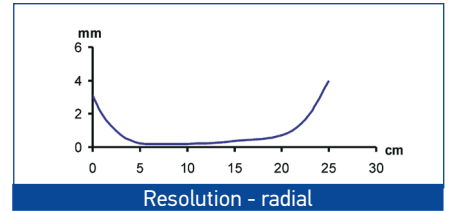
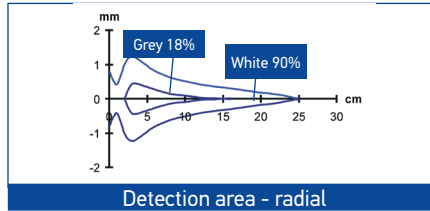
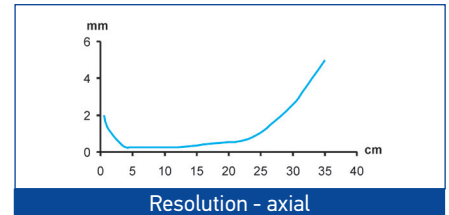
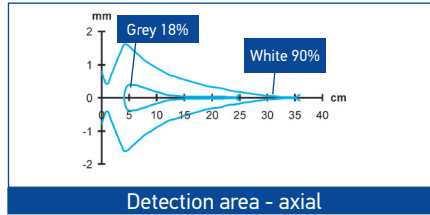

BACKGROUND SUPPRESSOR (M) AXIAL RED EMISSION

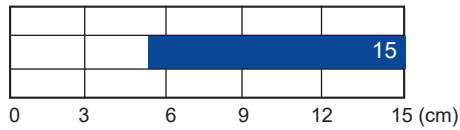

Operating distance

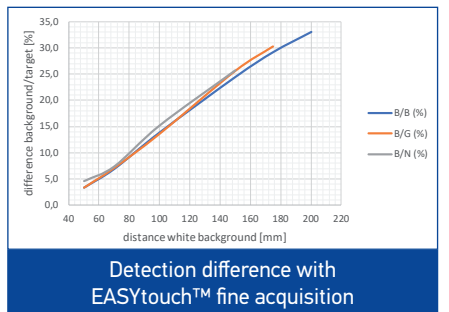
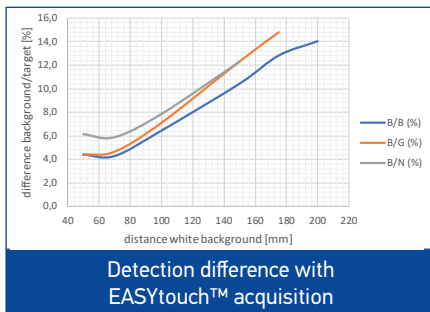

BACKGROUND SUPPRESSOR (M) RADIAL RED EMISSION

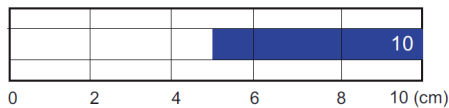

Operating distance

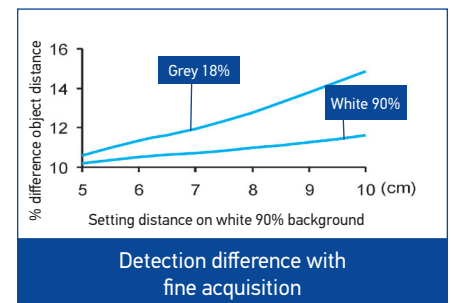
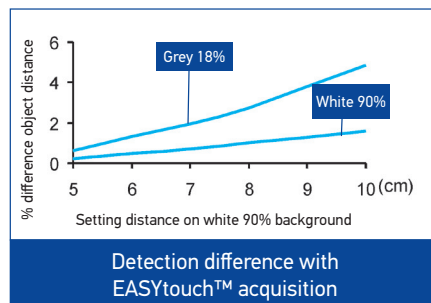

FIBER OPTIC (E) RED EMISSION

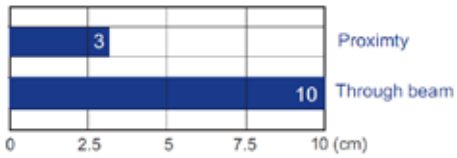

Operating distance with standard fibers

Standard Fiber-optics:
OF-42-ST-20 proximity
OF-43-ST-20 through beam

High efficiency fiber-optics or accessory lenses can be used to obtain larger operating distances.

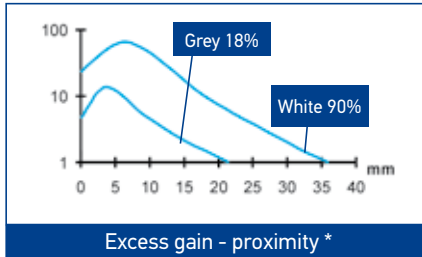

Excess gain - proximity *

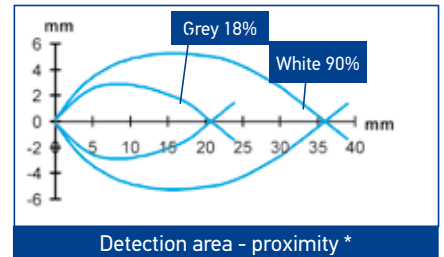

Detection area - proximity *

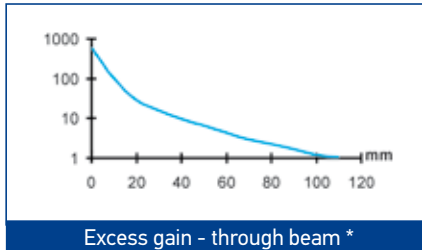

Excess gain - through beam *

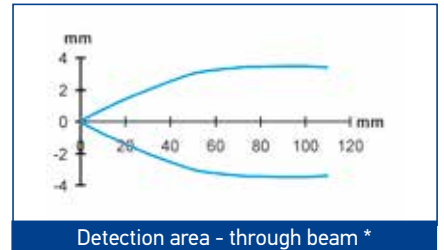

Detection area - through beam *

* standard Fiber-optics

MARK READER (W) WHITE EMISSION

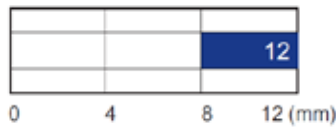

Operating distance

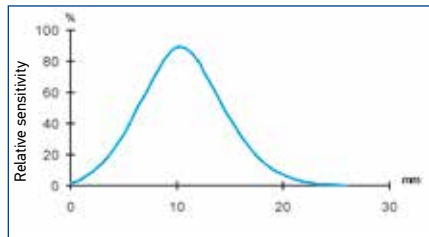

Operating distance

LUMINESCENCE (U) UV EMISSION





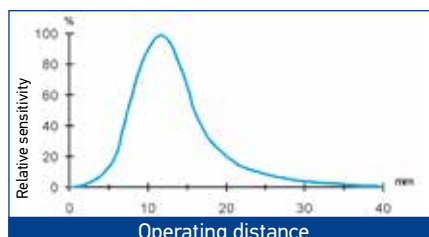

Operating distance





Operating distance



MODEL SELECTION AND ORDER INFORMATION

S5N PLASTIC MODELS					
OPTIC FUNCTION	EMISSION	CONNECTION	OUTPUT	MODEL	ORDER No.
Retroreflective	LED, Axial optic	2m Cable	NPN	S5N-PA-2-A00-NN	952002091
			PNP	S5N-PA-2-A00-PP	952002081
		M12 Connector	NPN	S5N-PA-5-A00-NN	952002111
			PNP	S5N-PA-5-A00-PP	952002101
Polarized retroreflective	LED, Axial optic	2m Cable	NPN	S5N-PA-2-B01-NN	952001611
			PNP	S5N-PA-2-B01-PP	952001011
		M12 Connector	NPN	S5N-PA-5-B01-NN	952001501
			PNP	S5N-PA-5-B01-PP	952001021
			 IO-Link	S5N-PA-5-B01-OZ	952002200
	LED, Radial optic	2m Cable	NPN	S5N-PR-2-B01-NN	952001781
			PNP	S5N-PR-2-B01-PP	952001031
		M12 Connector	NPN	S5N-PR-5-B01-NN	952001721
			PNP	S5N-PR-5-B01-PP	952001041
	LASER, Axial optic	2m Cable	NPN	S5N-PL-2-B01-NN	952001871
			PNP	S5N-PL-2-B01-PP	952001361
		M12 Connector	NPN	S5N-PL-5-B01-NN	952001841
			PNP	S5N-PL-5-B01-PP	952001371
			 IO-Link	S5N-PL-5-B01-OZ	952002250
	LASER, Radial optic	2m Cable	NPN	S5N-PH-2-B01-NN	952001951
			PNP	S5N-PH-2-B01-PP	952001941
		M12 Connector	NPN	S5N-PH-5-B01-NN	952001971
			PNP	S5N-PH-5-B01-PP	952001961
Long Diffuse proximity	LED, Axial optic	2m Cable	NPN	S5N-PA-2-C01-NN	952001621
			PNP	S5N-PA-2-C01-PP	952001051
		M12 Connector	NPN	S5N-PA-5-C01-NN	952001511
			PNP	S5N-PA-5-C01-PP	952001061
			 IO-Link	S5N-PA-5-C01-OZ	952002210
	LED, Radial optic	2m Cable	NPN	S5N-PR-2-C01-NN	952001791
			PNP	S5N-PR-2-C01-PP	952001071
		M12 Connector	NPN	S5N-PR-5-C01-NN	952001731
			PNP	S5N-PR-5-C01-PP	952001081
	LASER, Axial optic	2m Cable	NPN	S5N-PL-2-C01-NN	952001881
			PNP	S5N-PL-2-C01-PP	952001381
		M12 Connector	NPN	S5N-PL-5-C01-NN	952001851
			PNP	S5N-PL-5-C01-PP	952001391
			 IO-Link	S5N-PL-5-C01-OZ	952002260
	LASER, Radial optic	2m Cable	NPN	S5N-PH-2-C01-NN	952001991
			PNP	S5N-PH-2-C01-PP	952001981
		M12 Connector	NPN	S5N-PH-5-C01-NN	952002011
			PNP	S5N-PH-5-C01-PP	952002001
Short Diffuse proximity	LED, Axial optic	2m Cable	NPN	S5N-PA-2-C10-NN	952001631
			PNP	S5N-PA-2-C10-PP	952001241
		M12 Connector	NPN	S5N-PA-5-C10-NN	952001521
			PNP	S5N-PA-5-C10-PP	952001251
	LED, Radial optic	2m Cable	NPN	S5N-PR-2-C10-NN	952001801
			PNP	S5N-PR-2-C10-PP	952001491
		M12 Connector	NPN	S5N-PR-5-C10-NN	952001741
			PNP	S5N-PR-5-C10-PP	952001481
Medium Diffuse proximity	LED, Axial optic	2m Cable	NPN	S5N-PA-2-C21-NN	952002171
			PNP	S5N-PA-2-C21-PP	952002161
		M12 Connector	NPN	S5N-PA-5-C21-NN	952002191
			PNP	S5N-PA-5-C21-PP	952002181
	LED, Axial optic	2m Cable	NPN	S5N-PA-2-D00-NN	952001641
			PNP	S5N-PA-2-D00-PP	952001091
Fixed focus	M12 Connector	NPN	S5N-PA-5-D00-NN	952001531	
		PNP	S5N-PA-5-D00-PP	952001101	
	LED, Radial optic	2m Cable	NPN	S5N-PR-2-D00-NN	952001811
			PNP	S5N-PR-2-D00-PP	952001111
M12 Connector	NPN	S5N-PR-5-D00-NN	952001751		
	PNP	S5N-PR-5-D00-PP	952001121		

S5N PLASTIC MODELS

Fiber optic	LED, Axial optic	2m Cable	NPN	S5N-PA-2-E01-NN	952001651
			PNP	S5N-PA-2-E01-PP	952001131
		M12 Connector	NPN	S5N-PA-5-E01-NN	952001541
			PNP	S5N-PA-5-E01-PP	952001141
Through beam receiver	LED, Axial optic	2m Cable	NPN	S5N-PA-2-F01-NN	952001661
			PNP	S5N-PA-2-F01-PP	952001151
	M12 Connector	NPN	S5N-PA-5-F01-NN	952001551	
		PNP	S5N-PA-5-F01-PP	952001161	
	LED, Radial optic	2m Cable	NPN	S5N-PR-2-F01-NN	952001821
			PNP	S5N-PR-2-F01-PP	952001171
	M12 Connector	NPN	S5N-PR-5-F01-NN	952001761	
		PNP	S5N-PR-5-F01-PP	952001181	
	LASER, Axial optic	2m Cable	NPN	S5N-PL-2-F01-NN	952001891
			PNP	S5N-PL-2-F01-PP	952001401
	M12 Connector	NPN	S5N-PL-5-F01-NN	952001861	
		PNP	S5N-PL-5-F01-PP	952001411	
LASER, Radial optic	2m Cable	NPN	S5N-PH-2-F01-NN	952002031	
		PNP	S5N-PH-2-F01-PP	952002021	
M12 Connector	NPN	S5N-PH-5-F01-NN	952002051		
	PNP	S5N-PH-5-F01-PP	952002041		
Through beam emitter	LED, Axial optic	2m Cable	-	S5N-PA-2-G00-XG	952001191
		M12 Connector	-	S5N-PA-5-G00-XG	952001201
	LED, Radial optic	2m Cable	-	S5N-PR-2-G00-XG	952001211
		M12 Connector	-	S5N-PR-5-G00-XG	952001221
	LASER, Axial optic	2m Cable	-	S5N-PL-2-G00-XG	952001421
		M12 Connector	-	S5N-PL-5-G00-XG	952001431
	LASER, Radial optic	2m Cable	-	S5N-PH-2-G00-XG	952002061
		M12 Connector	-	S5N-PH-5-G00-XG	952002071
Background suppression	LED, Axial optic	2m Cable	NPN	S5N-PA-2-M03-NN	952001671
			PNP	S5N-PA-2-M03-PP	952001231
		M12 Connector	NPN	S5N-PA-5-M03-NN	952001561
			PNP	S5N-PA-5-M03-PP	952001001
	LED, Radial optic	M12 Connector	 IO-Link	S5N-PA-5-M03-OZ	952002230
			PNP	S5N-PS-5-M03-PP	952001931
		2m Cable	NPN	S5N-PS-5-M03-NN	952001921
			PNP	S5N-PS-2-M03-PP	952001911
Retroreflective for transparent	LED, Axial optic	2m Cable	NPN	S5N-PA-2-T01-NN	952001691
			PNP	S5N-PA-2-T01-PP	952001261
		M12 Connector	NPN	S5N-PA-5-T01-NN	952001581
			PNP	S5N-PA-5-T01-PP	952001271
	LED, Radial optic	2m Cable	 IO-Link	S5N-PA-5-T01-OZ	952002220
			NPN	S5N-PR-2-T01-NN	952001831
		M12 Connector	PNP	S5N-PR-2-T01-PP	952001281
			NPN	S5N-PR-5-T01-NN	952001771
		2m Cable	PNP	S5N-PR-5-T01-PP	952001291
			NPN	S5N-PA-2-U03-NN	952001701
Luminescence	LED, Axial optic	2m Cable	PNP	S5N-PA-2-U03-PP	952001301
			M12 Connector	NPN	S5N-PA-5-U03-NN
Contrast	LED, Axial optic	2m Cable		PNP	S5N-PA-5-U03-PP
			NPN	S5N-PA-2-W03-NN	952001711
		M12 Connector	PNP	S5N-PA-2-W03-PP	952001321
			NPN	S5N-PA-5-W03-NN	952001601
			PNP	S5N-PA-5-W03-PP	952001331
			 IO-Link	S5N-PA-5-W03-OZ	952002240

S5N METAL MODELS

OPTIC FUNCTION	EMISSION	CONNECTION	OUTPUT	MODEL	ORDER No.
Retroreflective	LED, Axial optic	2m Cable	NPN	S5N-MA-2-A00-NN	952022091
			PNP	S5N-MA-2-A00-PP	952022081
		M12 Connector	NPN	S5N-MA-5-A00-NN	952022111
			PNP	S5N-MA-5-A00-PP	952022101
Polarized retroreflective	LED, Axial optic	2m Cable	NPN	S5N-MA-2-B01-NN	952021501
			PNP	S5N-MA-2-B01-PP	952021001
		M12 Connector	NPN	S5N-MA-5-B01-NN	952021661
			PNP	S5N-MA-5-B01-PP	952021201
	LED, Radial optic	2m Cable	 IO-Link	S5N-MA-5-B01-OZ	952022160
			NPN	S5N-MR-2-B01-NN	952021601
		M12 Connector	PNP	S5N-MR-2-B01-PP	952021141
			NPN	S5N-MR-5-B01-NN	952021761
	LASER, Axial optic	2m Cable	PNP	S5N-MR-5-B01-PP	952021341
			NPN	S5N-ML-2-B01-NN	952021821
		M12 Connector	PNP	S5N-ML-2-B01-PP	952021401
			NPN	S5N-ML-5-B01-NN	952021851
	LASER, Radial optic	2m Cable	PNP	S5N-ML-5-B01-PP	952021441
			 IO-Link	S5N-ML-5-B01-OZ	952022180
		M12 Connector	NPN	S5N-MH-2-B01-NN	952021951
			PNP	S5N-MH-2-B01-PP	952021941
Long Diffuse proximity	LED, Axial optic	2m Cable	NPN	S5N-MH-5-B01-PP	952021961
			PNP	S5N-MH-5-B01-PP	952021961
		M12 Connector	NPN	S5N-MH-5-B01-NN	952021971
			PNP	S5N-MH-5-B01-PP	952021961
	LED, Radial optic	2m Cable	NPN	S5N-MA-2-C01-NN	952021511
			PNP	S5N-MA-2-C01-PP	952021011
		M12 Connector	NPN	S5N-MA-5-C01-NN	952021671
			PNP	S5N-MA-5-C01-PP	952021211
	LASER, Axial optic	2m Cable	 IO-Link	S5N-MA-5-C01-OZ	952022200
			NPN	S5N-MR-2-C01-NN	952021611
		M12 Connector	PNP	S5N-MR-2-C01-PP	952021151
			NPN	S5N-MR-5-C01-NN	952021771
	LASER, Radial optic	2m Cable	PNP	S5N-MR-5-C01-PP	952021351
			NPN	S5N-ML-2-C01-NN	952021831
		M12 Connector	PNP	S5N-ML-2-C01-PP	952021411
			NPN	S5N-ML-5-C01-NN	952021861
Short Diffuse proximity	2m Cable	PNP	S5N-ML-5-C01-PP	952021451	
		 IO-Link	S5N-ML-5-C01-OZ	952022190	
	M12 Connector	NPN	S5N-MH-2-C01-NN	952021991	
		PNP	S5N-MH-2-C01-PP	952021981	
Medium Diffuse proximity	2m Cable	NPN	S5N-MH-5-C01-NN	952022011	
		PNP	S5N-MH-5-C01-PP	952022001	
	M12 Connector	NPN	S5N-MA-2-C10-NN	952021521	
		PNP	S5N-MA-2-C10-PP	952021021	
Short Diffuse proximity	2m Cable	NPN	S5N-MA-5-C10-NN	952021681	
		PNP	S5N-MA-5-C10-PP	952021221	
	M12 Connector	NPN	S5N-MR-2-C10-NN	952021621	
		PNP	S5N-MR-2-C10-PP	952021491	
Medium Diffuse proximity	2m Cable	NPN	S5N-MR-5-C10-NN	952021781	
		PNP	S5N-MR-5-C10-PP	952021481	
	M12 Connector	NPN	S5N-MA-2-C21-NN	952022131	
		PNP	S5N-MA-2-C21-PP	952022121	
Medium Diffuse proximity	LED, Axial optic	2m Cable	NPN	S5N-MA-5-C21-NN	952022151
		M12 Connector	PNP	S5N-MA-5-C21-PP	952022141

S5N METAL MODELS

Fixed focus	LED, Axial optic	2m Cable	NPN	S5N-MA-2-D00-NN	952021531	
			PNP	S5N-MA-2-D00-PP	952021031	
	M12 Connector	NPN	S5N-MA-5-D00-NN	952021691		
		PNP	S5N-MA-5-D00-PP	952021231		
	LED, Radial optic	2m Cable	NPN	S5N-MR-2-D00-NN	952021631	
			PNP	S5N-MR-2-D00-PP	952021161	
	M12 Connector	NPN	S5N-MR-5-D00-NN	952021791		
Fiber optic	LED, Axial optic	2m Cable	PNP	S5N-MR-5-D00-PP	952021361	
			NPN	S5N-MA-2-E01-NN	952021881	
	M12 Connector	NPN	S5N-MA-2-E01-PP	952021041		
		PNP	S5N-MA-5-E01-NN	952021891		
		PNP	S5N-MA-5-E01-PP	952021241		
		NPN	S5N-MA-2-F01-NN	952021541		
Through beam receiver	LED, Axial optic	2m Cable	PNP	S5N-MA-2-F01-PP	952021051	
			NPN	S5N-MA-5-F01-NN	952021701	
	M12 Connector	PNP	S5N-MA-5-F01-PP	952021251		
		NPN	S5N-MR-2-F01-NN	952021641		
	LED, Radial optic	2m Cable	PNP	S5N-MR-2-F01-PP	952021171	
			NPN	S5N-MR-5-F01-NN	952021801	
	M12 Connector	PNP	S5N-MR-5-F01-PP	952021371		
		NPN	S5N-ML-2-F01-NN	952021841		
	LASER, Axial optic	2m Cable	PNP	S5N-ML-2-F01-PP	952021421	
			NPN	S5N-ML-5-F01-NN	952021871	
	M12 Connector	PNP	S5N-ML-5-F01-PP	952021461		
		NPN	S5N-MH-2-F01-NN	952022031		
	LASER, Radial optic	2m Cable	PNP	S5N-MH-2-F01-PP	952022021	
			NPN	S5N-MH-5-F01-NN	952022051	
		M12 Connector	PNP	S5N-MH-5-F01-PP	952022041	
	Through beam emitter	LED, Axial optic	2m Cable	-	S5N-MA-2-G00-XG	952021061
			M12 Connector	-	S5N-MA-5-G00-XG	952021261
		LED, Radial optic	2m Cable	-	S5N-MR-2-G00-XG	952021181
M12 Connector			-	S5N-MR-5-G00-XG	952021381	
LASER, Axial optic		2m Cable	-	S5N-ML-2-G00-XG	952021431	
		M12 Connector	-	S5N-ML-5-G00-XG	952021471	
LASER, Radial optic	2m Cable	-	S5N-MH-2-G00-XG	952022061		
	M12 Connector	-	S5N-MH-5-G00-XG	952022071		
Background suppression	LED, Axial optic	2m Cable	NPN	S5N-MA-2-M03-NN	952021551	
			PNP	S5N-MA-2-M03-PP	952021071	
	M12 Connector	PNP	S5N-MA-5-M03-PP	952021271		
		 IO-Link	S5N-MA-5-M03-OZ	952022170		
	LED, Radial optic	M12 Connector	PNP	S5N-MS-5-M03-PP	952021931	
		2m Cable	PNP	S5N-MS-2-M03-PP	952021911	
Retroreflective for transparent	LED, Axial optic	2m Cable	NPN	S5N-MA-2-T01-NN	952021571	
			PNP	S5N-MA-2-T01-PP	952021091	
	M12 Connector	NPN	S5N-MA-5-T01-NN	952021731		
		PNP	S5N-MA-5-T01-PP	952021291		
	LED, Radial optic	2m Cable	NPN	S5N-MR-2-T01-NN	952021651	
			PNP	S5N-MR-2-T01-PP	952021191	
	M12 Connector	NPN	S5N-MR-5-T01-NN	952021811		
		PNP	S5N-MR-5-T01-PP	952021391		
Luminescence	LED, Axial optic	M12 Connector	PNP	S5N-MA-5-U03-PP	952021301	
Contrast	LED, Axial optic	2m Cable	PNP	S5N-MA-2-W03-PP	952021111	
		M12 Connector	NPN	S5N-MA-5-W03-NN	952021751	
			PNP	S5N-MA-5-W03-PP	952021311	

ACCESSORIES

ST-5010

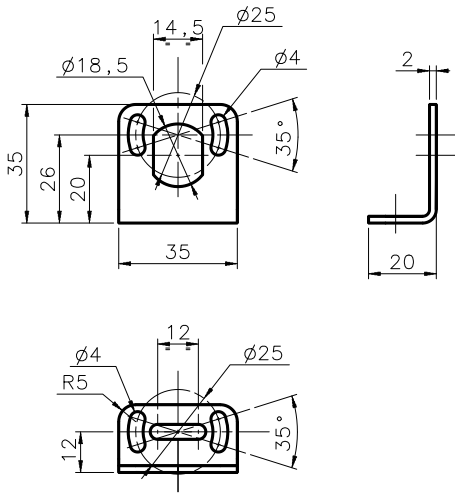

ST-5011

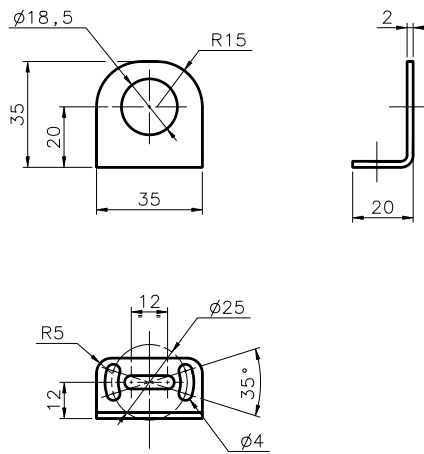

ST-5012

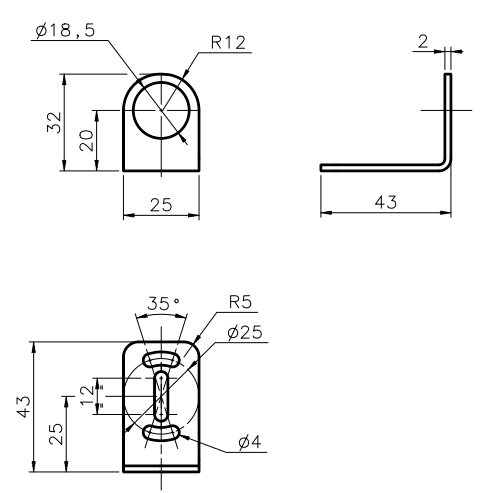

ST-5017

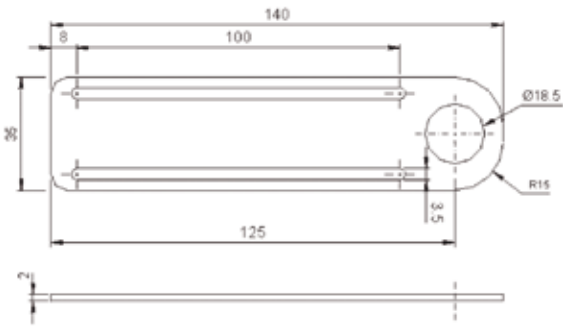

SWING-18

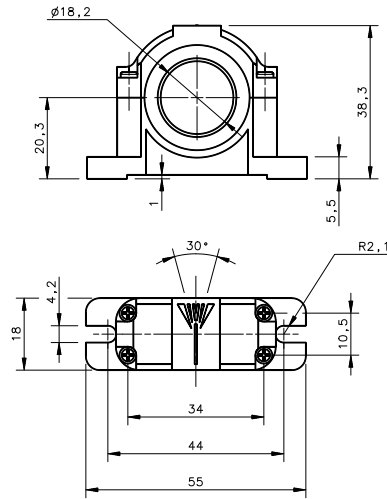

SP-40

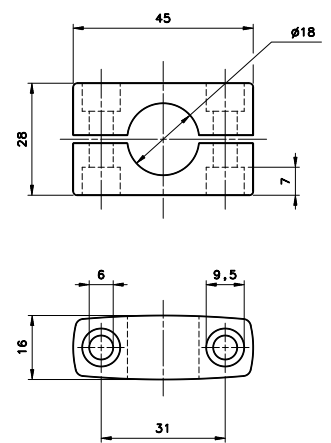

JOINT 18

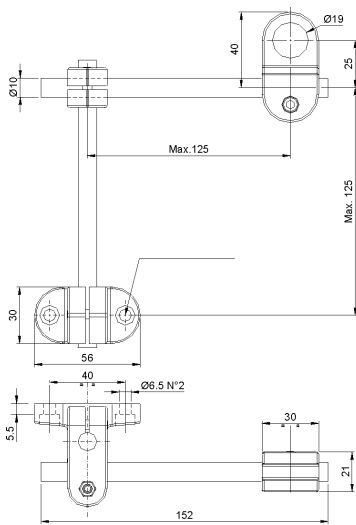

MICRO 18

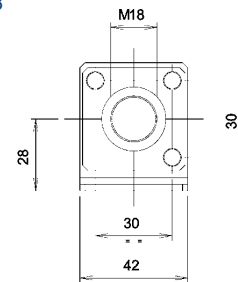
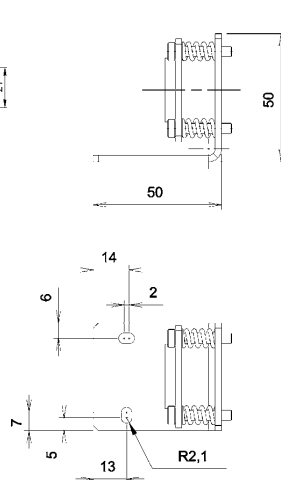

M18 FLARED PLASTIC NUT

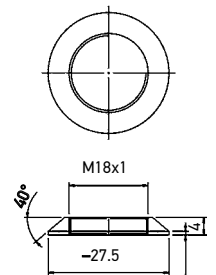

mm

MODEL	DESCRIPTION	ORDER No.
ST-5010	M18/14 mounting bracket	95ACC5230
ST-5011	M18 mounting bracket short	95ACC5240
ST-5012	M18 mounting bracket long	95ACC5250
ST-5017	M18 mounting bracket	95ACC5270
S50 EASY -IN	M18/14 EASY in™ adjustable mounting support	95ACC 5300
JOINT -18	M18 jointed support	95ACC 5220
MICRO -18	support with micrometric regulation for tubular M18 sensors	95ACC 1380
SP-40	mounting bracket tubular	95ACC1370
SWING-18	adjustable support for M18 tubular sensors	895000006
PLASTIC NUT	flared mounting nut	95ACC2630
M18 FLARED NUT	S5N mounting nut M18 flared nut (1 pc)	95ACC2630
M18 METAL NUT	S5N mounting nut M18 nut (1 pc)	G602000017
M18 PLASTIC NUT KIT	S5N mounting nut M18 nuts kit (100 pcs)	G602000008
MEK -PROOF	front protection (only for metal models)	G5000001

IO-LINK CONNECTIVITY

MODEL	DESCRIPTION	ORDER No.
CBX-8IOL-EIP	CBX-8IOL-EIP 8P IOL M12 EIP MASTER	95ACC8180
CBX-8IOL-PNIO	CBX-8IOL-PNIO 8P IOL M12 PROFINET MASTER	95ACC8190

CABLES

TYPE	DESCRIPTION	LENGTH	MODEL	ORDER No.
Axial M12 Connector	4-pole, grey, P.V.C.	3 m	CS-A1-02-G-03	95A251380
		5 m	CS-A1-02-G-05	95A251270
		7 m	CS-A1-02-G-07	95A251280
		10 m	CS-A1-02-G-10	95A251390
	4-pole, P.U.R.	2 m	CS-A1-02-R-02	95A251540
		5 m	CS-A1-02-R-05	95A251560
Radial M12 Connector	4-pole, grey, P.V.C.	3 m	CS-A2-02-G-03	95A251360
		5 m	CS-A2-02-G-05	95A251240
		7 m	CS-A2-02-G-07	95A251245
		10 m	CS-A2-02-G-10	95A251260
	4-pole, P.U.R.	2 m	CS-A2-02-R-02	95A251550
		5 m	CS-A2-02-R-05	95A251570
Radial M12 Connector with LED (for PNP N.O. sensors)	4-pole, grey, P.V.C.	3 m	CS-A2-12-G-03	95A251400
		5 m	CS-A2-12-G-05	95A251350
		10 m	CS-A2-12-G-10	95A251370
Axial M12 Connector	4-pole, shielded, black, P.V.C.	3 m	CV-A1-22-B-03	95ACC1480
		5 m	CV-A1-22-B-05	95ACC1490
		10 m	CV-A1-22-B-10	95ACC1500
		15 m	CV-A1-22-B-15	95ACC2070
		25 m	CV-A1-22-B-25	95ACC2090
Radial M12 Connector	4-pole, shielded, black, P.V.C.	3 m	CV-A2-22-B-03	95ACC1540
		5 m	CV-A2-22-B-05	95ACC1550
		10 m	CV-A2-22-B-10	95ACC1560
Axial M12 Connector	4-pole, U.L., black, P.V.C.	3 m	CS-A1-02-U-03	95ASE1120
		5 m	CS-A1-02-U-05	95ASE1130
		10 m	CS-A1-02-U-10	95ASE1140
		15 m	CS-A1-02-U-15	95ASE1150
		25 m	CS-A1-02-U-25	95ASE1160
	4-pole, black	Connector- not cabled	CS-A1-02-B-NC	G5085002
Radial M12 Connector	4-pole, black	Connector- not cabled	CS-A2-02-B-NC	G5085003
Axial M12 Connector	5-pole, L coded power cable	3 m	CS-M1-02-B-03	95ACC0007
Axial M12 F/M8 M Connector	4-pole, double headed	3 m	CS-H1-02-B-03	95ACC0008
Axial M12 F/M12 M Connector	4-pole, double headed	3 m	CS-I1-02-B-03	95ACC0009

S62



THE MOST COMPLETE UNIVERSAL SENSOR IN A COMPACT 50X50 MM HOUSING

- Sensors with red, infrared LED or LASER emission
- Background suppression from 3 cm to 2 m
- Polarized retroreflective up to 20 m
- Multivoltage 24-240Vac/24-60Vdc with Relay output
- NPN/PNP output NO-NC configuration

APPLICATIONS

- Processing and Packaging machinery
- Conveyor lines, material handling



S62		
Through beam	0...25 m	
Retroreflective (on R2 reflector)	0,1...13 m	
Polarized retroreflective	0,1...8 m	
	0,3...20 m (class 2 LASER)	
Diffuse proximity	short 0...900 mm, long 0...2000 mm	
	0...900 mm (class 2 LASER)	
	short 30...300 mm	
	medium 60...600 mm	
	long 60...1200 mm	
	very long 200...2000 mm	
Background suppression	short LASER 30...150 mm (class 2 LASER)	
	long LASER 50...350 mm (class 2 LASER)	
Power supply	Vdc	10...30 V
	Vac	
	Vac/dc	24/240 Vac/24...60 Vdc
Output	PNP	•
	NPN	•
	NPN/PNP	•
	relay	•
	other	•
Connection	cable	•
	connector	•
	pig-tail	
Approximate dimensions (mm)	18x50x50	
Housing material	ABS	
Mechanical protection	IP67	

TECHNICAL DATA

Power supply	10 ... 30 Vdc (mod. S62...2/5) 24...240 Vac/ 24...60 Vdc (mod. S62...1)
Ripple	2 Vpp max. (mod. S62...2/5), 10% max. (mod. S62...1)
Consumption (output current excluded)	30 mA max. (mod. S62...2/5) 3 VA max. (mod. S62...1)
Light emission	red LED 640 nm (mod. S62-PA...A/B/C/G/M01/M05/M11/M15) IR LED 880 nm (mod. S62-PA...M21/M25/M31/M35) red Laser 645...665 nm (mod. S62-PL)
Setting	sensitivity adjustment trimmer
Operating mode	mono-turn LIGHT/DARK trimmer (mod. S62...RX/PN)
Indicators	yellow OUTPUT LED green STABILITY LED, POWER LED (S62...G)
Output	PNP or NPN N.O./N.C. (mod. S62...PP/NN); NPN/PNP (mod. S62...PN); electromechanical SPDT 250 Vac/30 Vdc (mod. S62...RX)
Output current	100 mA max. (mod. S62...2/5), 2 A max. (mod. S62...1)
Saturation voltage	2 V max. (mod. S62...2/5)
Response time	25 ms (mod. S62...1) 1,5 ms (mod. S62...M3x) 1 ms (mod. S62...2/5-F/G/M2x) 500 µs (mod. S62-PA...2/5-A/B/C/M0x/M1x) 200 µs (mod. S62-PL...B/C/M11) 140 µs (mod. S62-PL...M01)
Switching frequency	20 Hz (mod. S62...1) 330 Hz (mod. S62...M3x) 500 Hz (mod. S62...2/5-F/G/M2x) 1 kHz (mod. S62-PA...2/5-A/B/C/M0x/M1x) 2,5 kHz (mod. S62-PL...B/C/M11) 3,5 kHz (mod. S62-PL...M01)
Connection	M12 4-pole connector, 2 m Ø 4 mm cable vers., 2 m Ø 5 mm cable vers.
Dielectric strength	500 Vac 1 min., between electronics and housing
Insulation resistance	>20 MΩ 500 Vdc, between electronics and housing
Mechanical protection	IP67
Ambient light rejection	According to EN 60947-5-2
Vibrations	0.5 mm amplitude, 10 ... 55 Hz frequency, for each axis (EN60068-2-6)
Shock resistance	11 ms (30G) 6 shock for every axis (EN60068-2-27)
Housing material	ABS
Lens material	PMMA window, polycarbonate lens
Operating temperature	-10 ... 55 °C
Storage temperature	-20 ... 70 °C
Weight	40 g max. conn. vers., 90 max. cable vers.

DIMENSIONS

Background suppression

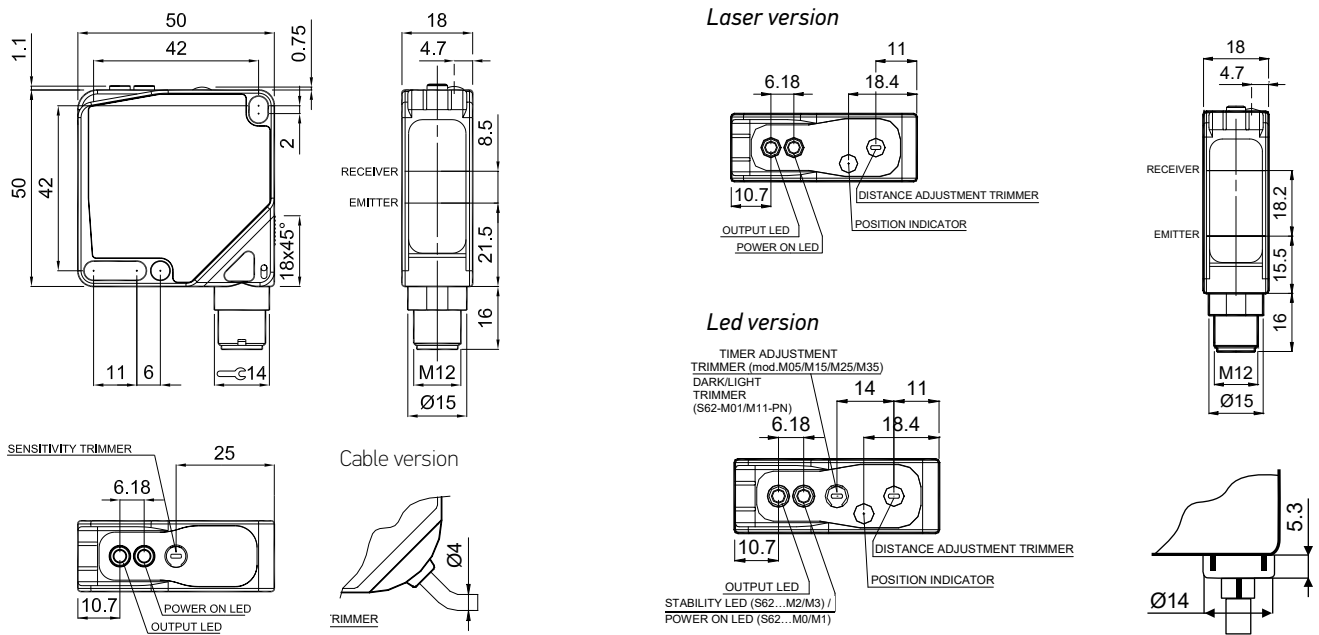

AC Models cable output

CONNECTIONS

VDC MODELS

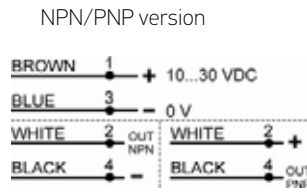
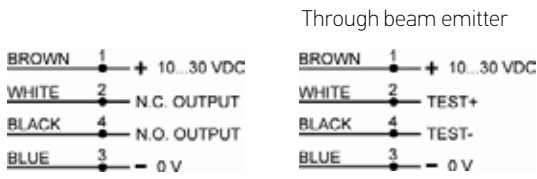

M12 CONNECTOR

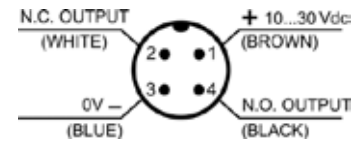

VAC MODELS



INDICATORS AND SETTINGS

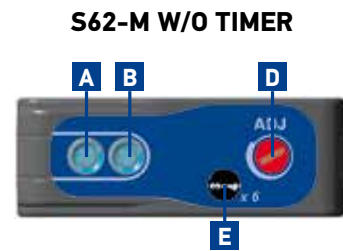
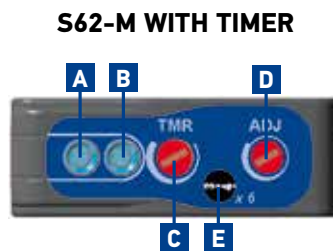
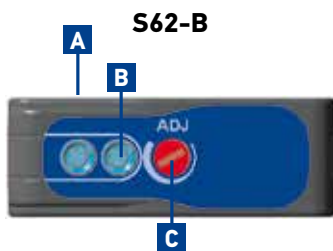

- A** Output status LED
- B** Stability LED or Power ON LED (laser vers.)
- C** Timer adjustment trimmer

- D** Distance adjustment trimmer
- E** Geared numeric scale
- F** M12 connector output
- G** Cable output

DETECTION DIAGRAMS OF MODELS WITH LED EMISSION

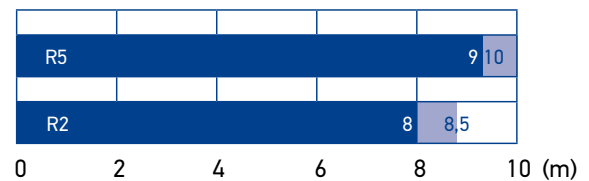
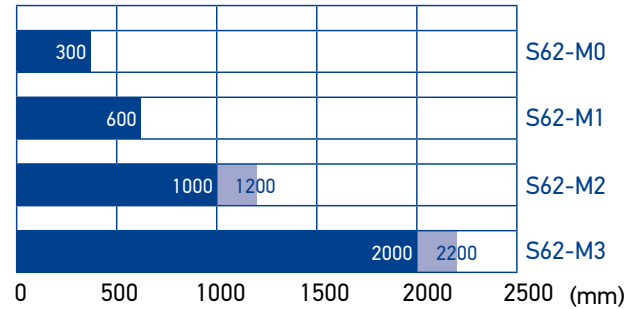
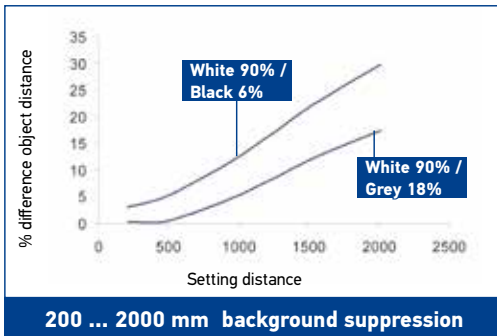
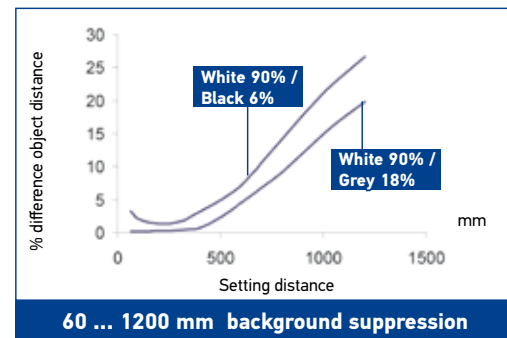
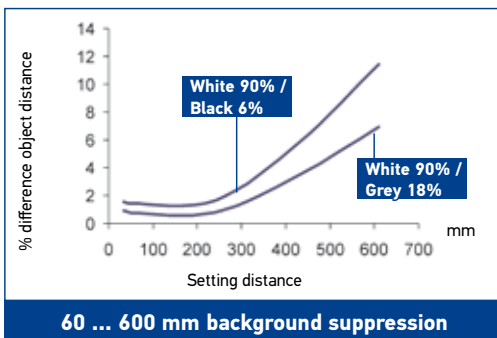
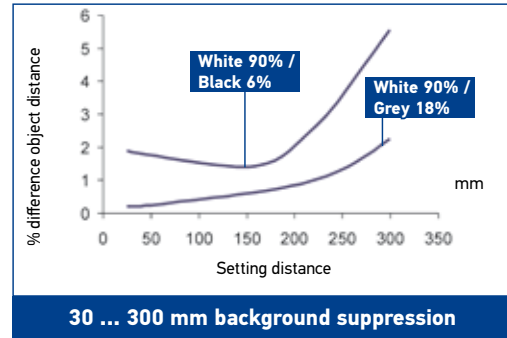
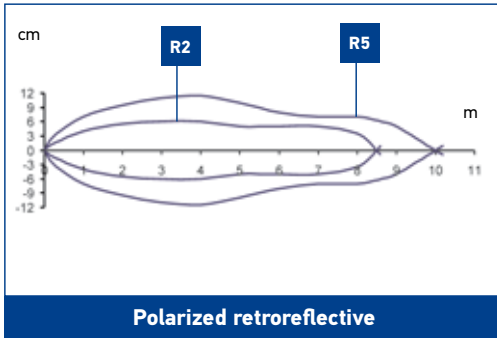

■ Recommended operating distance
 ■ Maximum operating distance

DETECTION DIAGRAMS OF MODELS WITH LASER EMISSION

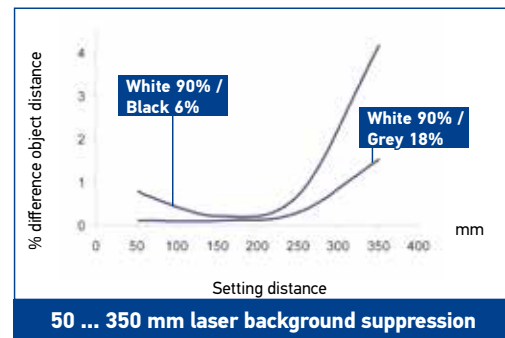
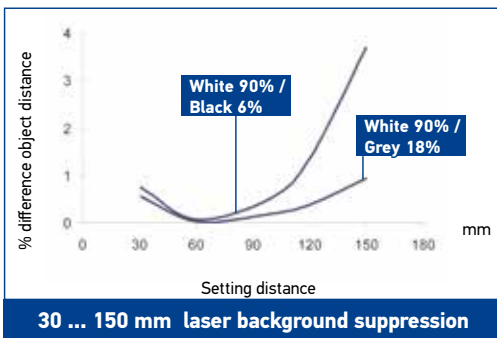
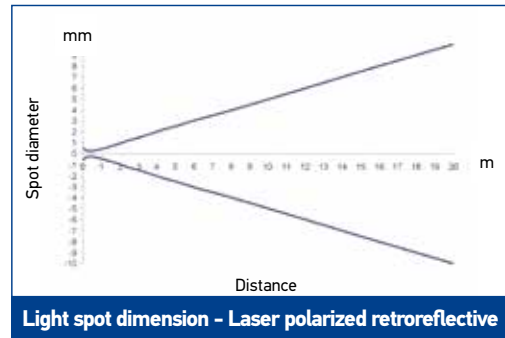
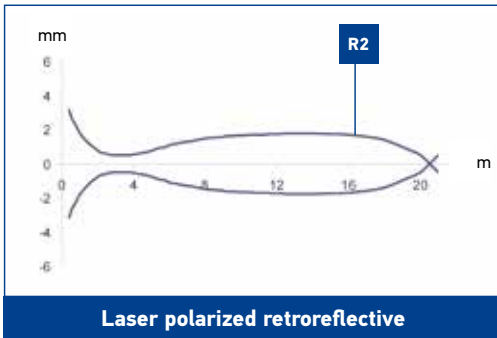

Reflector operating distances (m)				
R1	R2	R6	R7 / R20	R8
0.3 ... 16	0.3 ... 20	0.4 ... 22	0.3 ... 22	0.2 ... 2

The use of the RT3970 reflecting tape is suggested.

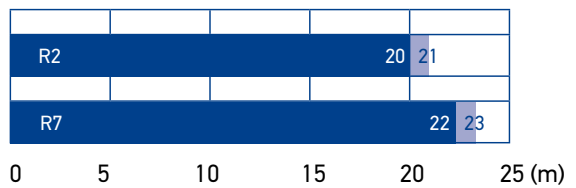
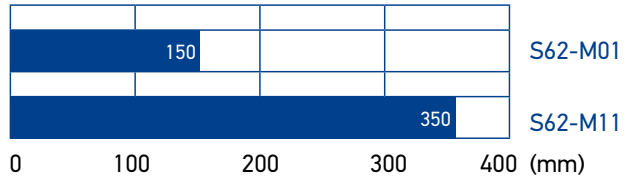

- Recommended operating distance
- Maximum operating distance

MODEL SELECTION AND ORDER INFORMATION

OPTIC FUNCTION	EMISSION	CONNECTION	SETTING	OUTPUT	MODEL	ORDER No.				
Retroreflective	LED (red 640nm)	2m Cable	sensitivity trimmer (mono turn)	PNP/NPN	S62-PA-2-A01-PN	956211240				
		M12 Connector		PNP/NPN	S62-PA-5-A01-PN	956211310				
		Vac relay	mono-turn light/dark trimmer	Relay	S62-PA-1-A01-RX	956211180				
Polarized retroreflective	LED (red 640nm)	2m Cable	sensitivity trimmer (mono-turn)	PNP/NPN	S62-PA-2-B01-PN	956211250				
		M12 Connector		PNP	S62-PA-2-B01-PP	956211010				
				NPN	S62-PA-5-B01-NN	956211020				
		Vac relay		mono-turn light/dark trimmer	PNP/NPN	S62-PA-5-B01-PN	956211320			
	LASER	M12 Connector	mono-turn light/dark trimmer	PNP	S62-PA-5-B01-PP	956211000				
				Relay	S62-PA-1-B01-RX	956211190				
Short diffused proximity	LED (red 640nm)	2m Cable	sensitivity trimmer (mono-turn)	NPN	S62-PL-5-B01-NN	956211100				
		M12 Connector		PNP	S62-PL-5-B01-PP	956211110				
				Vac relay	mono-turn light/dark trimmer	Relay	S62-PA-1-C01-RX	956211200		
		LASER		M12 Connector	mono-turn light/dark trimmer	NPN	S62-PA-2-C01-NN	956211420		
						PNP/NPN	S62-PA-2-C01-PN	956211260		
						PNP	S62-PA-2-C01-PP	956211380		
	Long diffused proximity	LED (red 640nm)	2m Cable	sensitivity trimmer (mono turn)	NPN	S62-PA-5-C01-NN	956211500			
			M12 Connector		PNP/NPN	S62-PA-5-C01-PN	956211330			
					PNP	S62-PA-5-C01-PP	956211460			
			LASER		M12 Connector	mono-turn light/dark trimmer	Relay	S62-PA-1-C01-RX	956211200	
							NPN	S62-PL-2-C01-NN	956211440	
							PNP	S62-PL-2-C01-PP	956211400	
Through beam receiver	-	2m Cable	sensitivity trimmer (mono turn)	NPN	S62-PL-5-C01-NN	956211520				
		M12 Connector		PNP	S62-PL-5-C01-PP	956211480				
				Vac relay	mono-turn light/dark trimmer	Relay	S62-PA-1-C11-RX	956211200		
		LASER		M12 Connector	mono-turn light/dark trimmer	NPN	S62-PA-2-C11-NN	956211430		
						PNP/NPN	S62-PA-2-C11-PN	956211270		
						PNP	S62-PA-2-C11-PP	956211390		
	Through beam emitter	-	2m Cable	sensitivity trimmer (mono turn)	NPN	S62-PA-5-C11-NN	956211510			
			M12 Connector		PNP/NPN	S62-PA-5-C11-PN	956211340			
					PNP	S62-PA-5-C11-PP	956211470			
			Background suppression (short distance)		LED (red 640nm)	2m Cable	6 turns distance adjustment trimmer	Relay	S62-PA-1-C11-RX	956211210
						M12 Connector		NPN	S62-PA-2-F01-NN	956211450
								Vac relay	mono-turn light/dark trimmer	Relay
Background suppression (medium distance)	LED (red 640nm)	2m Cable	6 turns distance adjustment trimmer	PNP/NPN	S62-PA-2-F01-PN	956211290				
		M12 Connector		PNP	S62-PA-2-F01-PP	956211410				
				NPN	S62-PA-5-F01-NN	956211530				
		LASER		M12 Connector	4 turns distance adjustment trimmer	PNP/NPN	S62-PA-5-F01-PN	956211360		
						PNP	S62-PA-5-F01-PP	956211490		
						Relay	S62-PA-1-F01-RX	956211220		
Background suppression (long distance)	LED (red 640nm)	2m Cable	6 turns distance adjustment trimmer	-	S62-PA-2-G00-XG	956211300				
		M12 Connector		-	S62-PA-5-G00-XG	956211370				
				Vac relay	mono-turn light/dark trimmer	-	S62-PA-1-G00-XX	956211230		
		LASER		M12 Connector	4 turns distance adjustment trimmer	PNP/NPN	S62-PA-2-M01-PN	956211280		
						PNP	S62-PA-2-M01-PP	956201841		
						NPN	S62-PA-5-M01-NN	956201811		
	Background suppression (very long distance)	LED (infrared 880nm)	2m Cable	6 turns distance adjustment trimmer	PNP/NPN	S62-PA-5-M01-PN	956211350			
			M12 Connector		PNP	S62-PA-5-M01-PP	956201831			
					NPN	S62-PA-5-M05-NN	956201801			
			LASER		M12 Connector	4 turns distance adjustment trimmer	PNP	S62-PA-5-M05-PP	956201821	
							NPN	S62-PL-5-M01-NN	956211120	
							PNP	S62-PL-5-M01-PP	956211130	
Background suppression (medium distance)	LED (red 640nm)	2m Cable	6 turns distance adjustment trimmer	PNP	S62-PA-2-M11-PP	956201891				
		M12 Connector		NPN	S62-PA-5-M11-NN	956201861				
				PNP	S62-PA-5-M11-PP	956201881				
		LASER		M12 Connector	6 turns distance adjustment trimmer	NPN	S62-PA-5-M15-NN	956201851		
						PNP	S62-PA-5-M15-PP	956201871		
						NPN	S62-PL-5-M11-NN	956211140		
Background suppression (long distance)	LED (infrared 880nm)	2m Cable	6 turns distance adjustment trimmer	PNP	S62-PL-5-M11-PP	956211150				
		M12 Connector		PNP	S62-PA-2-M21-PP	956201940				
				NPN	S62-PA-5-M21-NN	956201910				
		LASER		M12 Connector	4 turns distance adjustment trimmer	PNP	S62-PA-5-M21-PP	956201900		
						NPN	S62-PA-5-M25-NN	956201930		
						PNP	S62-PA-5-M25-PP	956201920		
Background suppression (very long distance)	LED (infrared 880nm)	2m Cable	6 turns distance adjustment trimmer	PNP	S62-PA-2-M31-PP	956211050				
		M12 Connector		NPN	S62-PA-5-M31-NN	956211060				
				PNP	S62-PA-5-M31-PP	956211070				
		LASER		M12 Connector	4 turns distance adjustment trimmer	NPN	S62-PA-5-M35-NN	956211080		
						PNP	S62-PA-5-M35-PP	956211090		
						PNP	S62-PA-5-M35-PP	956211090		

CABLES

TYPE	DESCRIPTION	LENGTH	MODEL	ORDER No.
Axial M12 Connector	4-pole, grey, P.V.C.	3 m	CS-A1-02-G-03	95A251380
		5 m	CS-A1-02-G-05	95A251270
		7 m	CS-A1-02-G-07	95A251280
		10 m	CS-A1-02-G-10	95A251390
	4-pole, P.U.R.	2 m	CS-A1-02-R-02	95A251540
		5 m	CS-A1-02-R-05	95A251560
Radial M12 Connector	4-pole, grey, P.V.C.	3 m	CS-A2-02-G-03	95A251360
		5 m	CS-A2-02-G-05	95A251240
		7 m	CS-A2-02-G-07	95A251245
		10 m	CS-A2-02-G-10	95A251260
	4-pole, P.U.R.	2 m	CS-A2-02-R-02	95A251550
		5 m	CS-A2-02-R-05	95A251570
Radial M12 Connector with LED (for PNP N.O. sensors)	4-pole, grey, P.V.C.	3 m	CS-A2-12-G-03	95A251400
		5 m	CS-A2-12-G-05	95A251350
		10 m	CS-A2-12-G-10	95A251370
Axial M12 Connector	4-pole, shielded, black, P.V.C.	3 m	CV-A1-22-B-03	95ACC1480
		5 m	CV-A1-22-B-05	95ACC1490
		10 m	CV-A1-22-B-10	95ACC1500
		15 m	CV-A1-22-B-15	95ACC2070
		25 m	CV-A1-22-B-25	95ACC2090
Radial M12 Connector	4-pole, shielded, black, P.V.C.	3 m	CV-A2-22-B-03	95ACC1540
		5 m	CV-A2-22-B-05	95ACC1550
		10 m	CV-A2-22-B-10	95ACC1560
Axial M12 Connector	4-pole, U.L., black, P.V.C.	3 m	CS-A1-02-U-03	95ASE1120
		5 m	CS-A1-02-U-05	95ASE1130
		10 m	CS-A1-02-U-10	95ASE1140
		15 m	CS-A1-02-U-15	95ASE1150
		25 m	CS-A1-02-U-25	95ASE1160
Radial M12 Connector	4-pole, black	Connector- not cabled	CS-A1-02-B-NC	G5085002
Radial M12 Connector	4-pole, black	Connector- not cabled	CS-A2-02-B-NC	G5085003

S70



ADVANCED FIBER OPTIC AMPLIFIERS FOR HIGH SPEED AND LOW CONTRAST APPLICATIONS

- DIN rail mounting
- Double digital display
- High Speed models: 200 μ s ... 5 ms
- Super High Speed models: 10 μ s ... 1ms
- Teach-in setting via switch / button + / SET / -,
- Remote input
- IO-Link communication V1.1 COM2 2,3ms cycle time
- High level of parameterization
- Normalized connection with 2 m or 4-pole M8 cable

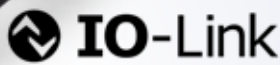

APPLICATIONS

- Processing and Packaging machinery
- Electronics assembling
- Pharmaceutical industry
- Cosmetic and bottling industries

S70

Response time		Super high speed: 10 μ s (S70...E2) High speed: 200 μ s (S70...E1), 15 μ s (S70...E2), 250 μ s (S70...E3) Fast: 50 μ s (S70...E2), 500 μ s (S70...E3) Standard: 500 μ s (S70...E1), 250 μ s (S70...E2), 1 ms (S70...E3) Medium range: 500 μ s (S70...E2) Long range: 2 ms (S70...E1), 1 ms (S70...E2), 4 ms (S70...E3) Extra long range: 5 ms (S70...E1), 12 ms (S70...E3)
	Repeatability	Super high speed: 5 μ s (S70...E2) High speed: 66 μ s (S70...E1), 5 μ s (S70...E2), 100 μ s (S70...E3) Fast: 12 μ s (S70...E2), 150 μ s (S70...E3) Standard: 100 μ s (S70...E1), 50 μ s (S70...E2), 180 μ s (S70...E3) Medium range: 80 μ s (S70...E2) Long range: 100 μ s (S70...E1), 165 μ s (S70...E2), 180 μ s (S70...E3) Extra long range: 100 μ s (S70...E1), 180 μ s (S70...E3)
Power supply	Vdc	10...30 V (current output models and digital output models) 12...30 (voltage output models) 18...30 V (mod. IO-Link mod. IO-Link -PZ)
	Vac	
	Vac/dc	
Output	PNP	•
	NPN	•
	NPN/PNP	
	relay	
	other	Analog out 4...20mA; Analog out 0...10V; Analog out 0...5V IO-Link V1.1 COM2 2,3ms cycle time (only model -PZ)
Connection	cable	•
	connector	•
	pig-tail	
Approximate dimensions (mm)		10x79x31.5
Housing material		ABS and polycarbonate
Mechanical protection		IP50, NEMA 1

TECHNICAL DATA

Power supply	10...30 V (current output models and digital output models) 12...30 (voltage output models)
Ripple	10% max.
Consumption (output current excluded)	40 mA max. (standard display mode), 30 mA max. (ECO display mode)
Light emission	red 660 nm (mod. S70...E1, S70...E3) red 635 nm (mod. S70...E2)
Setting	+ / SET / - push-button, LIGHT / DARK switch, RUN / PRG / ADJ mode switch yellow OUTPUT LED
Indicators	red SIGNAL LEVEL 4-digit display green THRESHOLD 4-digit display
Output	PNP or NPN PNP and push-pull (IO-Link mod. S70...PZ)
Output current	100 mA max.
Saturation voltage	1,5 V max. (mod. S70...N) 2 V max. (mod. S70...P/PZ)
Response time	Super high speed: 10 µs (S70...E2) High speed: 200 µs (S70...E1), 15 µs (S70...E2), 250 µs (S70...E3) Fast: 50 µs (S70...E2), 500 µs (S70...E3) Standard: 500 µs (S70...E1), 250 µs (S70...E2), 1 ms (S70...E3) Medium range: 500 µs (S70...E2) Long range: 2 ms (S70...E1), 1 ms (S70...E2), 4 ms (S70...E3) Extra long range: 5 ms (S70...E1), 12 ms (S70...E3)
Switching frequency	S70...E1: 2,5 kHz (High Speed), 1 kHz (Standard), 250 Hz (Long Range), 100 Hz (Extra Long Range) S70...E2: 50 kHz (Super High Speed), 33 kHz (High Speed), 10 kHz (Fast), 2 kHz (Standard), 1 kHz (Medium Range), 500 Hz (Long Range) S70...E3: 1 kHz (High Speed), 500 Hz (Fast), 250 Hz (Standard), 62,5 Hz (Long Range), 20 Hz (Extra Long Range)
IO-Link interface	baud rate: 38400 bps (COM2) process data width: 16 bits IODD files: provide all programming options of top panel interface, plus additional functionality 2,3ms cycle time V1.1.2 Smart Sensor Profile
Connection	2 m cable, M8 4-pole connector
Dielectric strength	500 Vac, 1 min between electronics and housing
Insulating resistance	>20 MΩ, 500 Vdc between electronics and housing
Electrical protection	class 2
Mechanical protection	IP50, NEMA 1
Ambient light rejection	according to EN 60947-5-2
Vibrations	0,5 mm amplitude, 10 ... 55 Hz frequency, for every axis (EN60068-2-6)
Shock resistance	11 ms (30 G) 6 shock for every axis (EN60068-2-27)
Housing material	ABS and polycarbonate
Operating temperature	-10 ... 55 °C
Storage temperature	-25 ... 85 °C
Weight	69 g max. cable vers., 21 g max. conn. vers.

DIMENSIONS

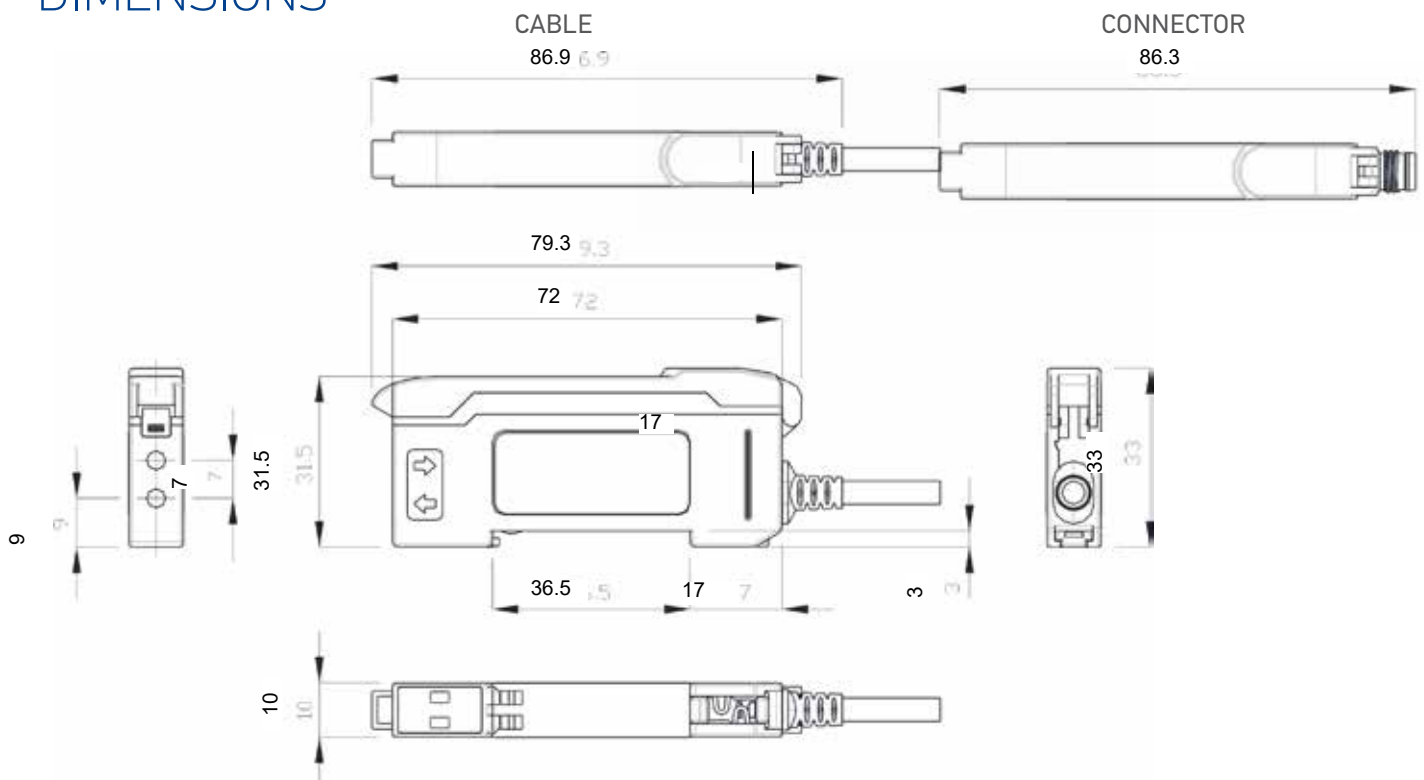

CONNECTIONS

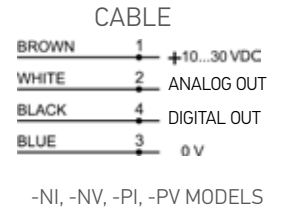
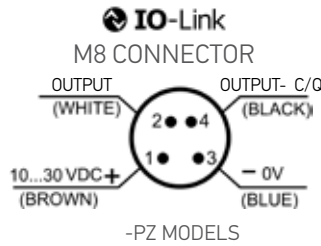
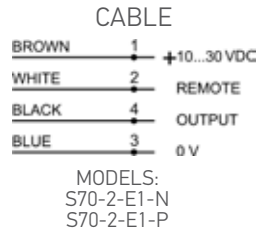
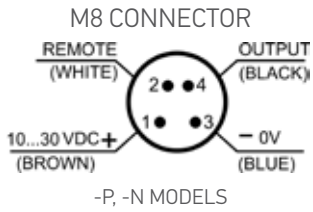

INDICATOR AND SETTINGS

The **RUN/PRG/ADJ Mode Switch** puts the sensor in RUN, PRG (Program), or ADJ (Adjust) mode. RUN mode allows the sensor to operate normally and prevents unintentional programming changes via the **+ /SET/ -** button. PRG mode allows the sensor to be programmed through the display driven programming menu. ADJ mode allows the user to perform TEACH and SET methods and Manual Adjust.

The **LO/DO Switch** is used to select Light Operate or Dark Operate mode.

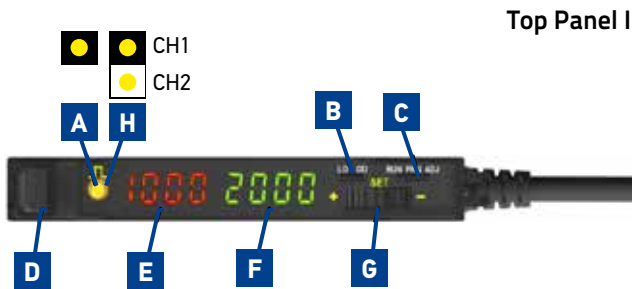

- A Output LED
- B LO/DO Switch
- C RUN/PRG/ADJ
- D Lever Action Fiber Clamp
- E Red Signal Level
- F Green Threshold
- G + /SET/ - Rocker Button
- H CH1 Analog out, CH2 Discrete out (only S70...E3)

As an alternative the sensor can be programmed remotely and the remote input may be used to perform TEACH and SET methods (not available on IO-Link models).

DETECTION DIAGRAMS

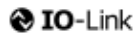

	S70-E1			
	HIGH SPEED	STANDARD	LONG RANGE	EXTRA LONG RANGE
Response Time	200 μ s	500 μ s	2 ms	5 ms
Repeatability	66 μ s	100 μ s	100 μ s	100 μ s

EXCESS GAIN

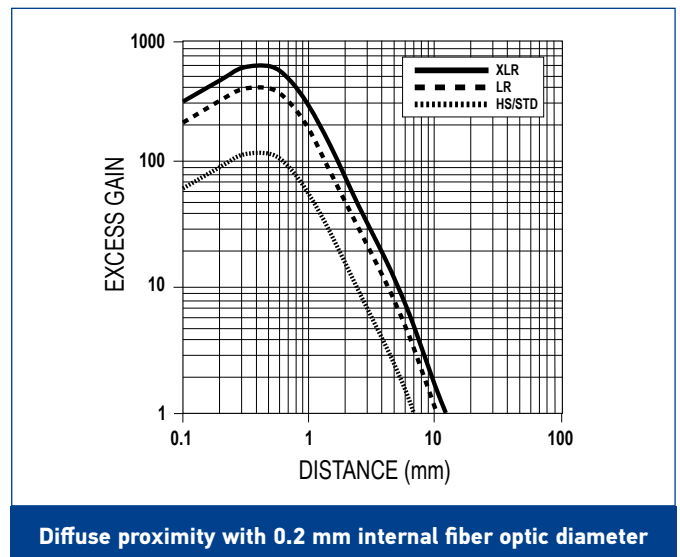
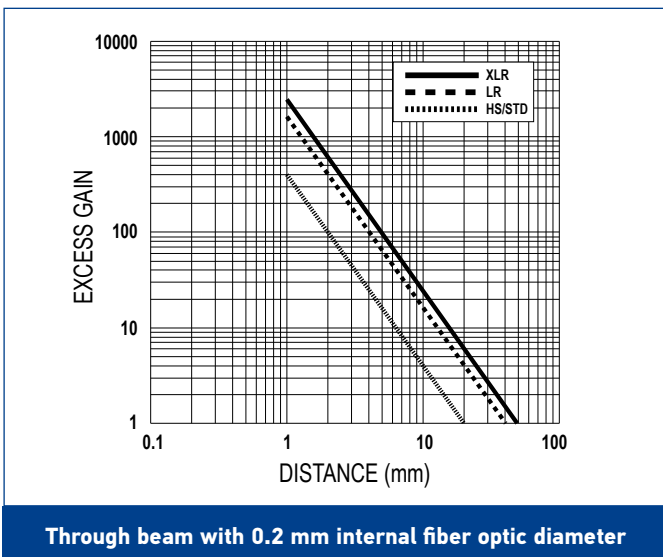

EXCESS GAIN

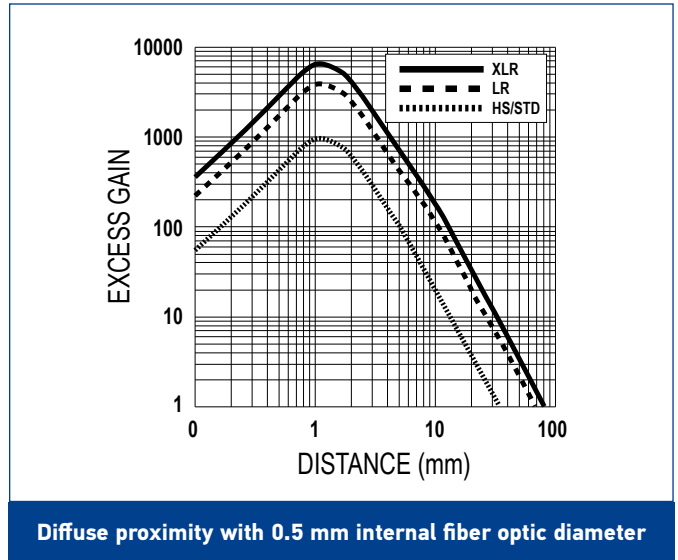
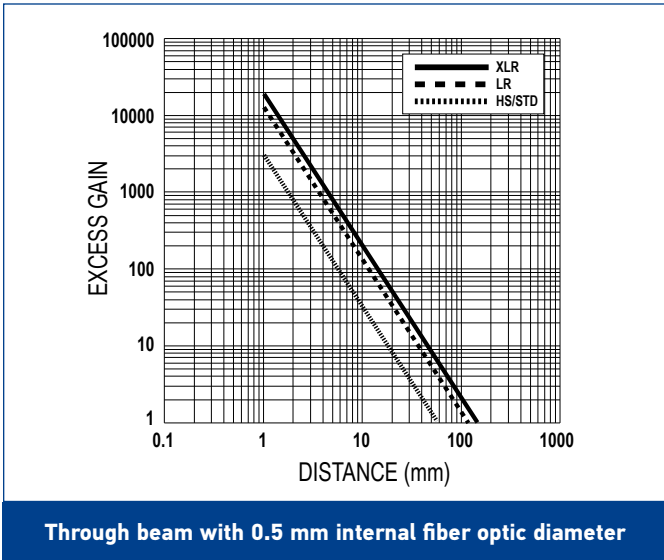

EXCESS GAIN

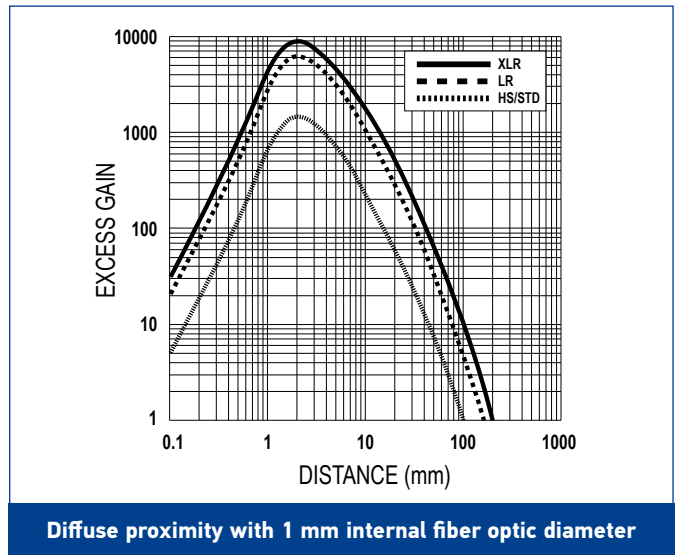
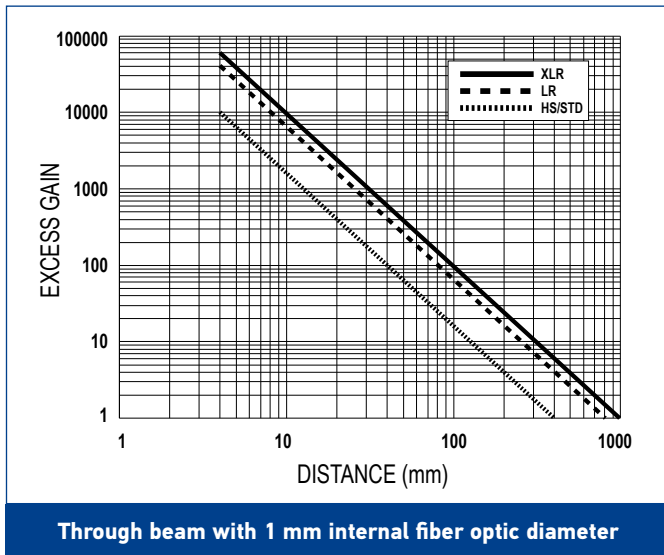

EXCESS GAIN

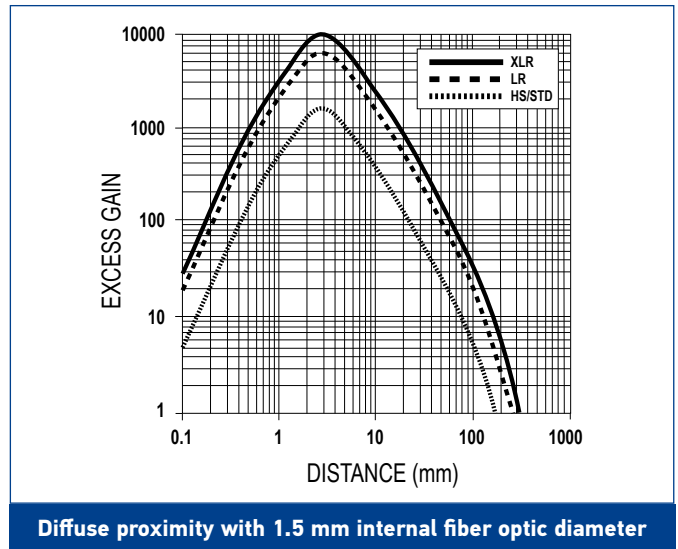
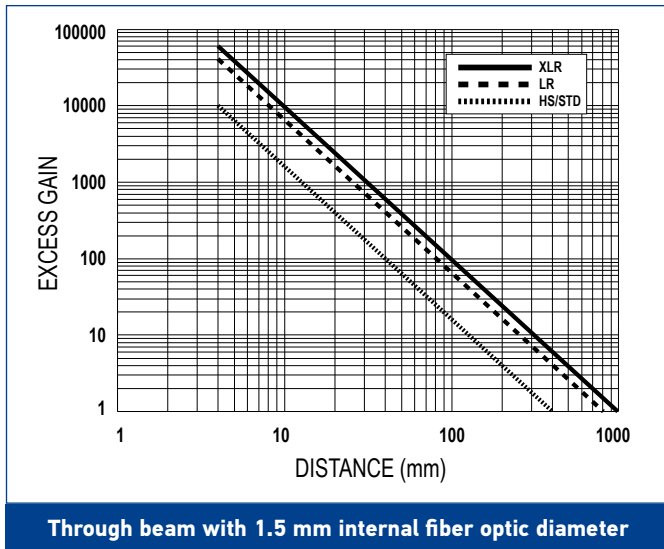

S70-E1

	HIGH SPEED	STANDARD	LONG RANGE	EXTRA LONG RANGE
Response Time	200 μ s	500 μ s	2 ms	5 ms
Repeatability	66 μ s	100 μ s	100 μ s	100 μ s

DETECTION AREA

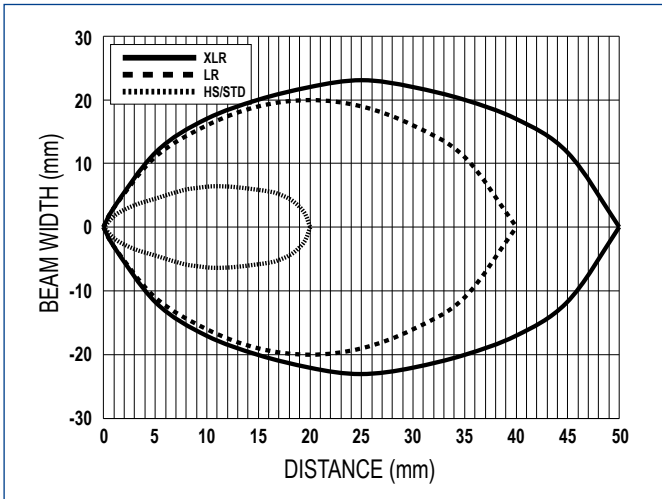

Through beam with 0.2 mm internal fiber optic diameter

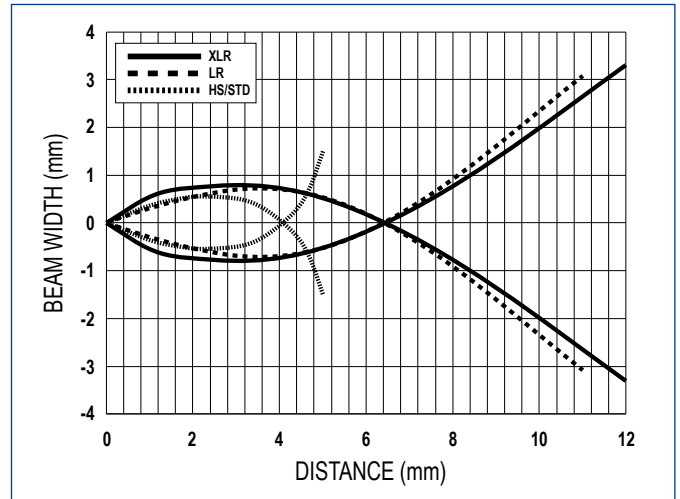

Diffuse proximity with 0.2 mm internal fiber optic diameter

DETECTION AREA

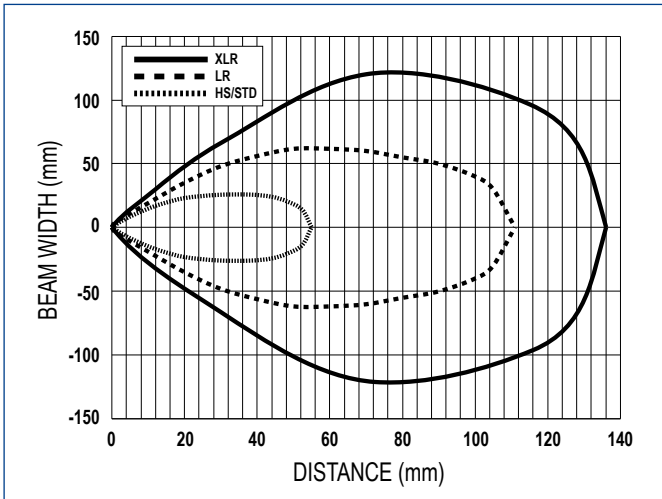

Through beam with 0.5 mm internal fiber optic diameter

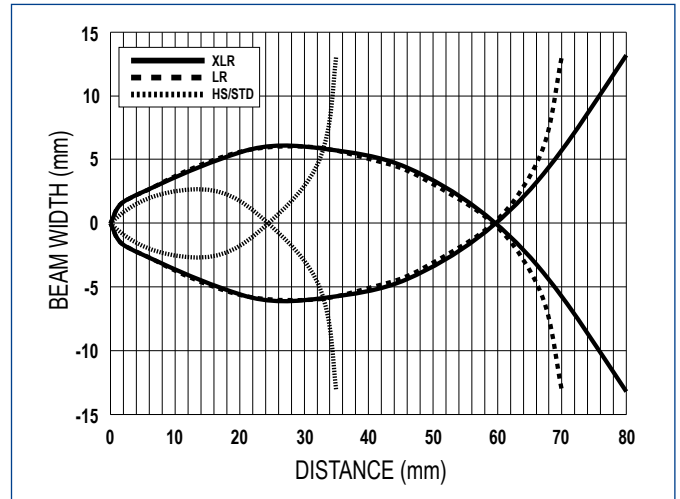

Diffuse proximity with 0.5 mm internal fiber optic diameter

S70-E1

	HIGH SPEED	STANDARD	LONG RANGE	EXTRA LONG RANGE
Response Time	200 μ s	500 μ s	2 ms	5 ms
Repeatability	66 μ s	100 μ s	100 μ s	100 μ s

DETECTION AREA

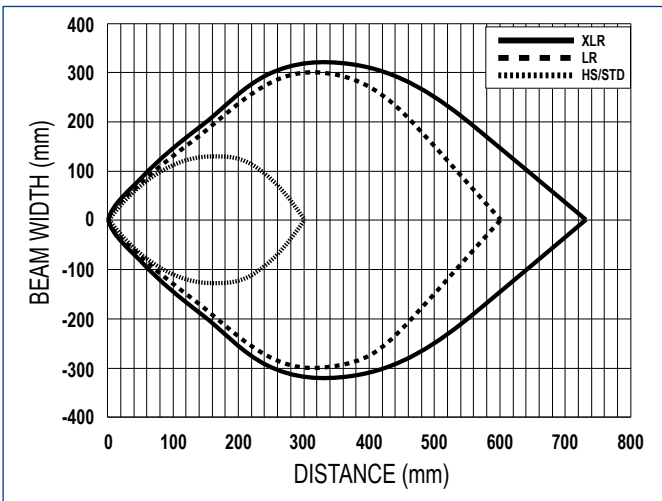

Through beam with 1 mm internal fiber optic diameter

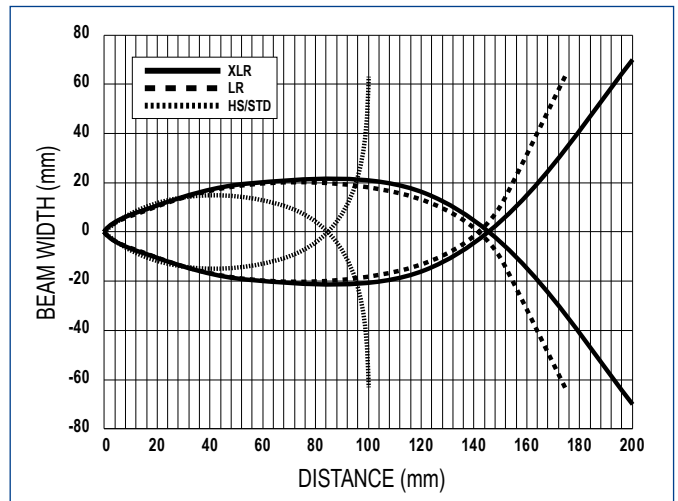

Diffuse proximity with 1 mm internal fiber optic diameter

DETECTION AREA

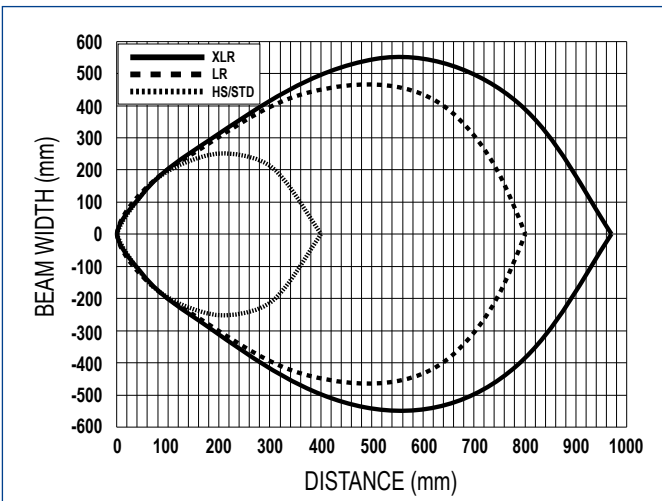

Through beam with 1.5 mm internal fiber optic diameter

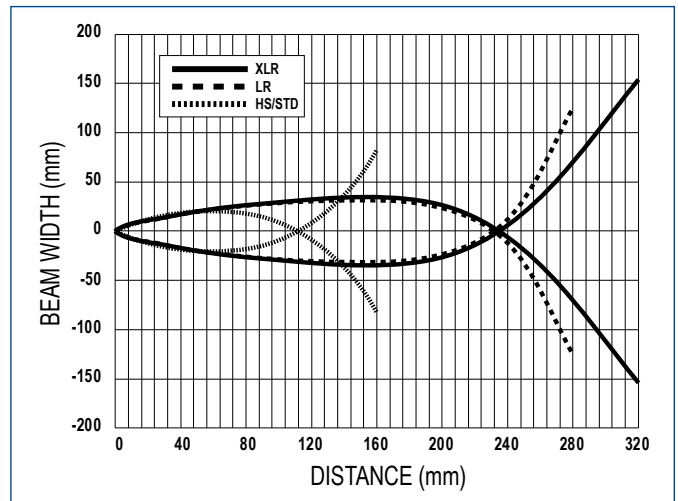

Diffuse proximity with 1.5 mm internal fiber optic diameter

S70-E2

	SUPER HIGH SPEED	HIGH SPEED	FAST	STANDARD	MEDIUM RANGE	LONG RANGE
Response Time	10 μ s	15 μ s	50 μ s	250 μ s	500 μ s	1 ms
Repeatability	5 μ s	5 μ s	12 μ s	50 μ s	80 μ s	165 μ s

EXCESS GAIN

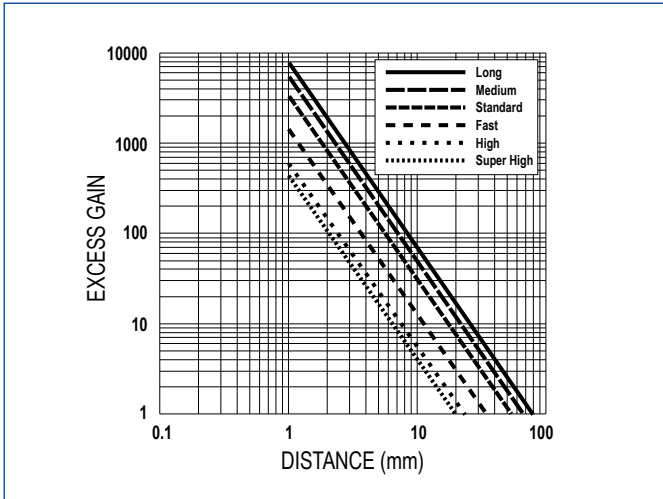

Through beam with 0.2 mm internal fiber optic diameter

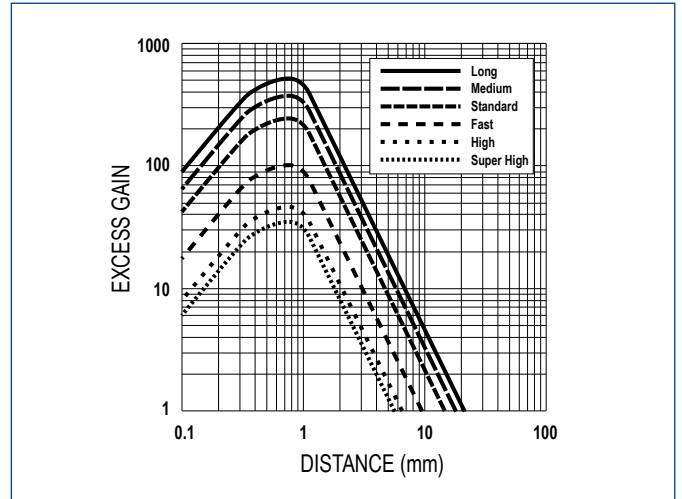

Diffuse proximity with 0.2 mm internal fiber optic diameter

EXCESS GAIN

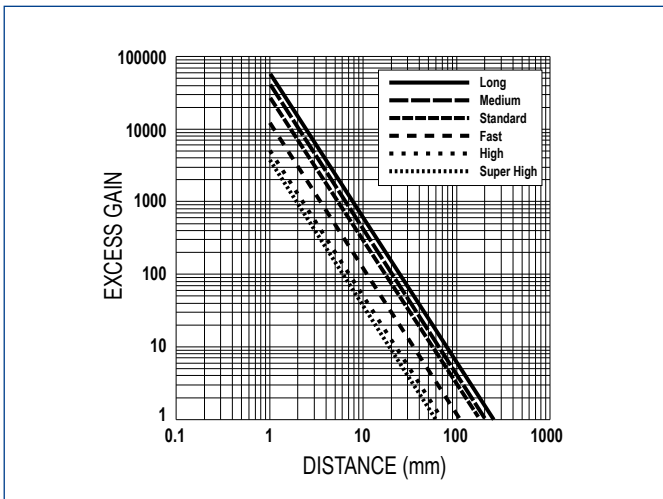

Through beam with 0.5 mm internal fiber optic diameter

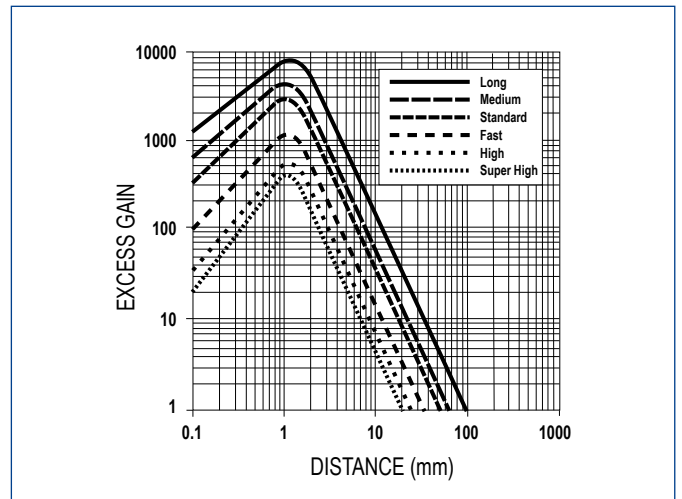

Diffuse proximity with 0.5 mm internal fiber optic diameter

S70-E2

	SUPER HIGH SPEED	HIGH SPEED	FAST	STANDARD	MEDIUM RANGE	LONG RANGE
Response Time	10 μ s	15 μ s	50 μ s	250 μ s	500 μ s	1 ms
Repeatability	5 μ s	5 μ s	12 μ s	50 μ s	80 μ s	165 μ s

EXCESS GAIN

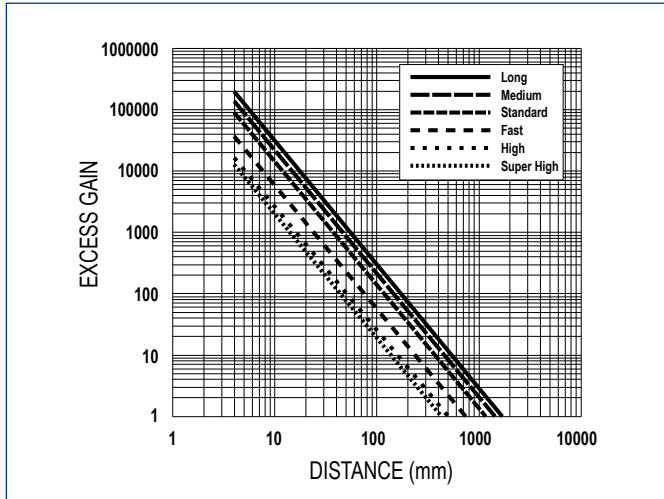

Through beam with 1 mm internal fiber optic diameter

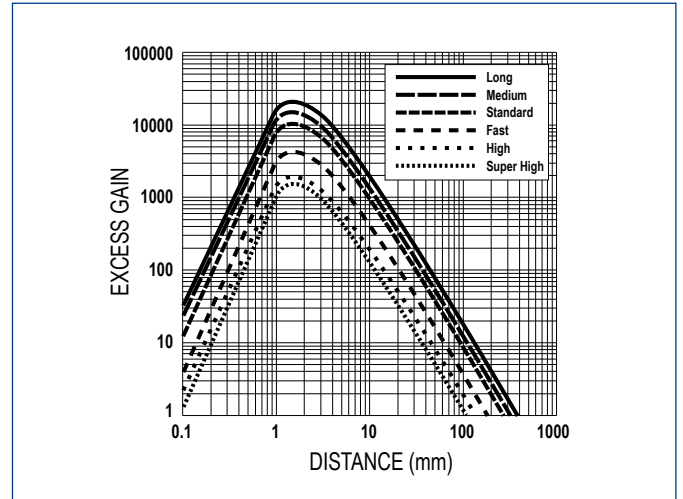

Diffuse proximity with 1 mm internal fiber optic diameter

EXCESS GAIN

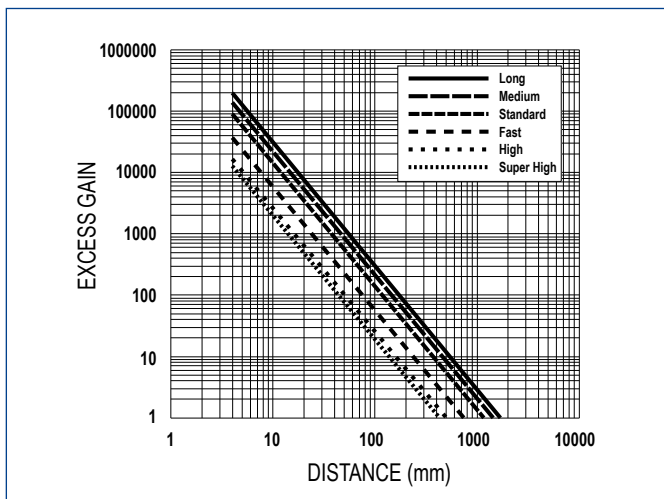

Through beam with 1.5 mm internal fiber optic diameter

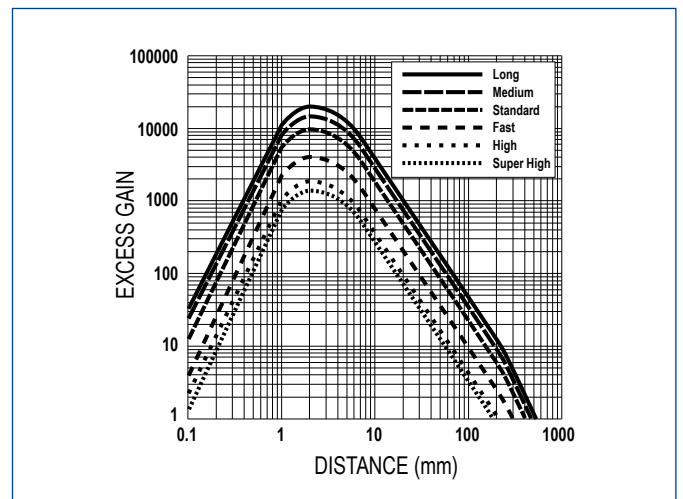

Diffuse proximity with 1.5 mm internal fiber optic diameter

S70-E2

	SUPER HIGH SPEED	HIGH SPEED	FAST	STANDARD	MEDIUM RANGE	LONG RANGE
Response Time	10 μ s	15 μ s	50 μ s	250 μ s	500 μ s	1 ms
Repeatability	5 μ s	5 μ s	12 μ s	50 μ s	80 μ s	165 μ s

DETECTION AREA

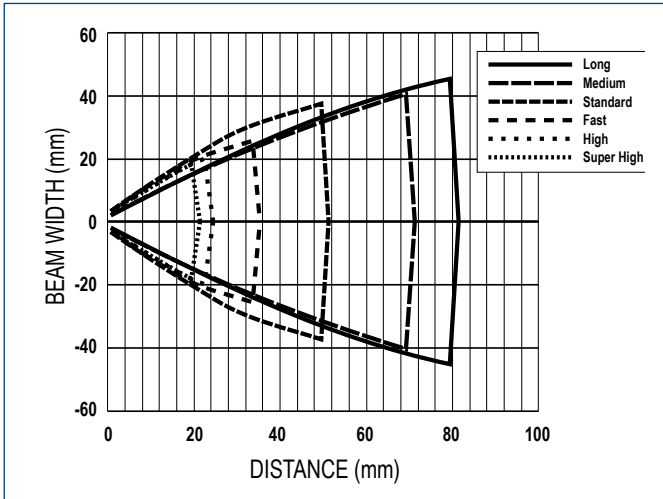

Through beam with 0.2 mm internal fiber optic diameter

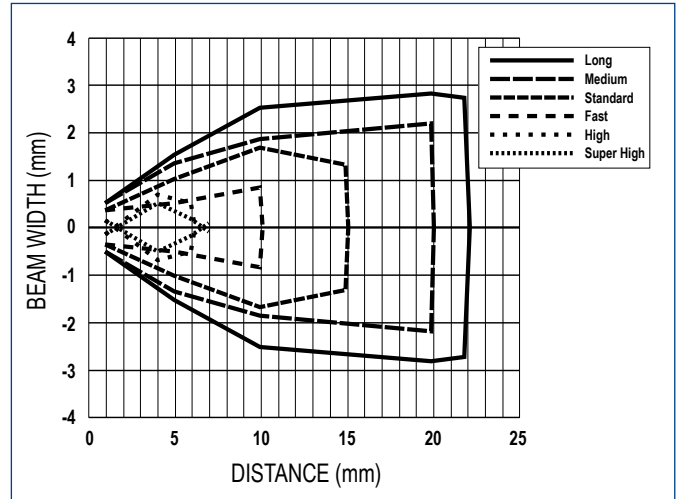

Diffuse proximity with 0.2 mm internal fiber optic diameter

DETECTION AREA

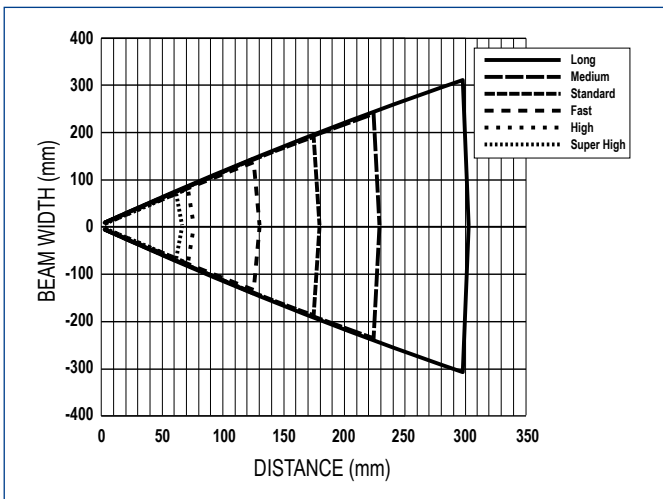

Through beam with 0.5 mm internal fiber optic diameter

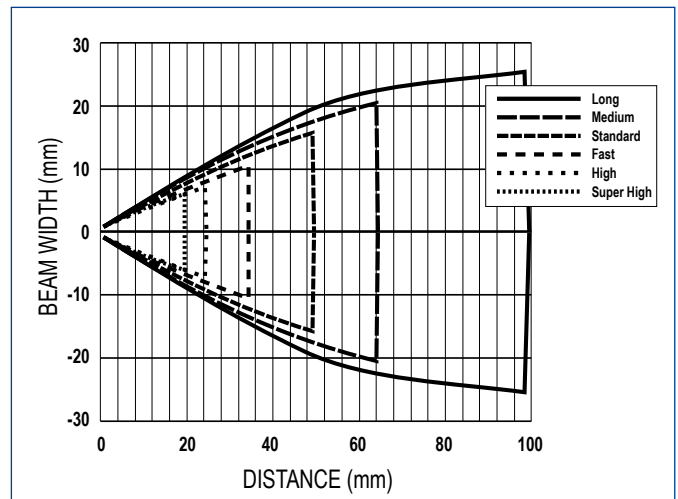

Diffuse proximity with 0.5 mm internal fiber optic diameter

S70-E2

	SUPER HIGH SPEED	HIGH SPEED	FAST	STANDARD	MEDIUM RANGE	LONG RANGE
Response Time	10 μ s	15 μ s	50 μ s	250 μ s	500 μ s	1 ms
Repeatability	5 μ s	5 μ s	12 μ s	50 μ s	80 μ s	165 μ s

DETECTION AREA

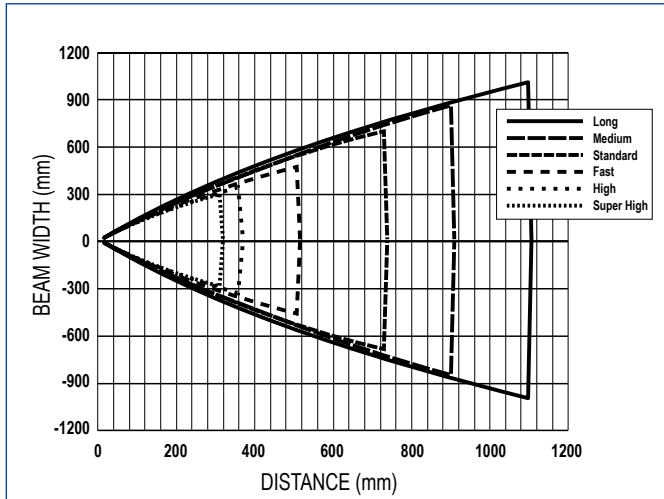

Through beam with 1 mm internal fiber optic diameter

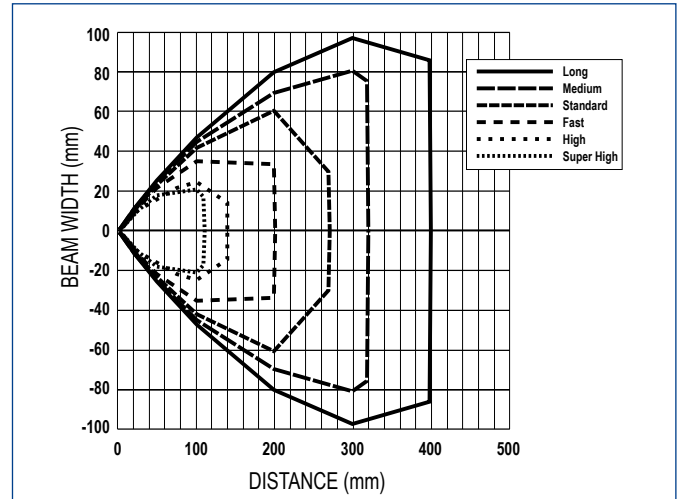

Diffuse proximity with 1 mm internal fiber optic diameter

DETECTION AREA

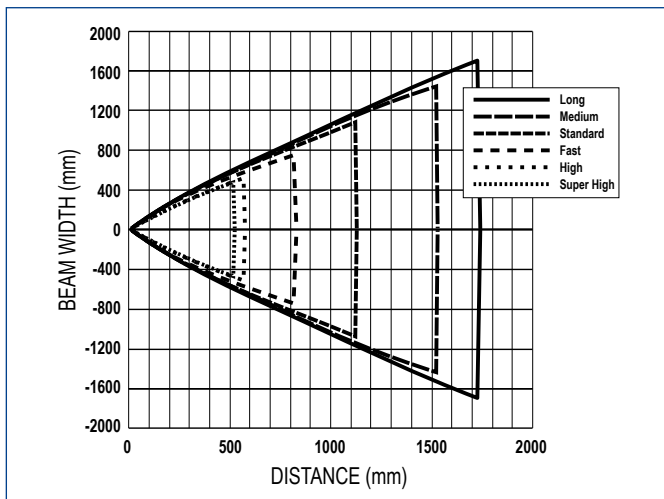

Through beam with 1.5 mm internal fiber optic diameter

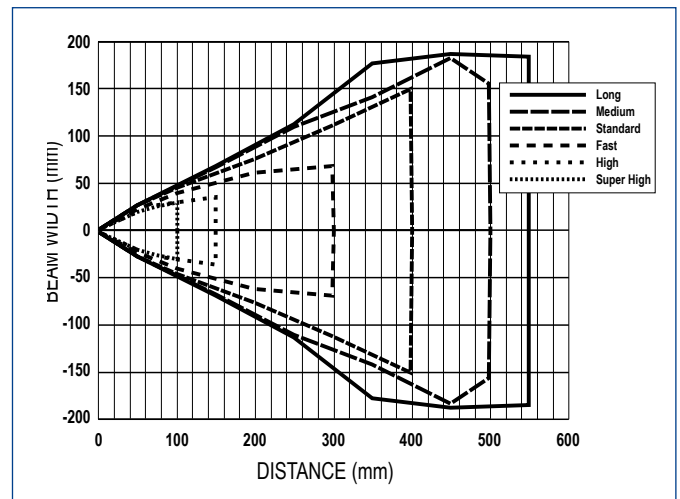

Diffuse proximity with 1.5 mm internal fiber optic diameter

S70-E3

	SUPER HIGH SPEED	HIGH SPEED	FAST	STANDARD	LONG RANGE	EXTRA LONG RANGE
Response Time	-	250 μ s	500 μ s	1 ms	4 ms	12 ms
Repeatability	-	100 μ s	150 μ s	180 μ s	180 μ s	180 μ s

EXCESS GAIN

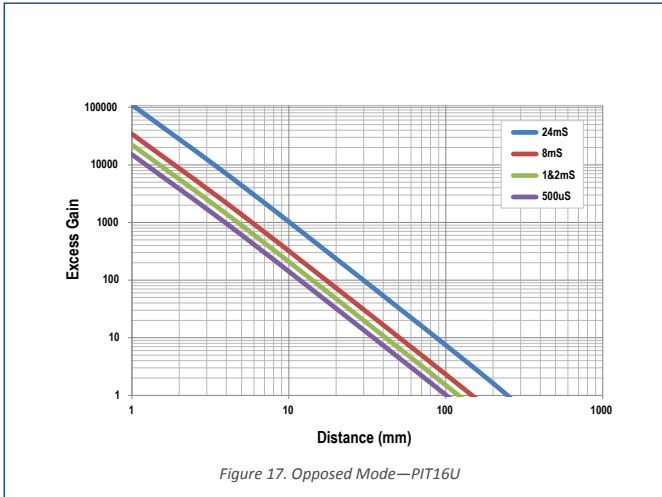

Through beam with 0.2 mm internal fiber optic diameter

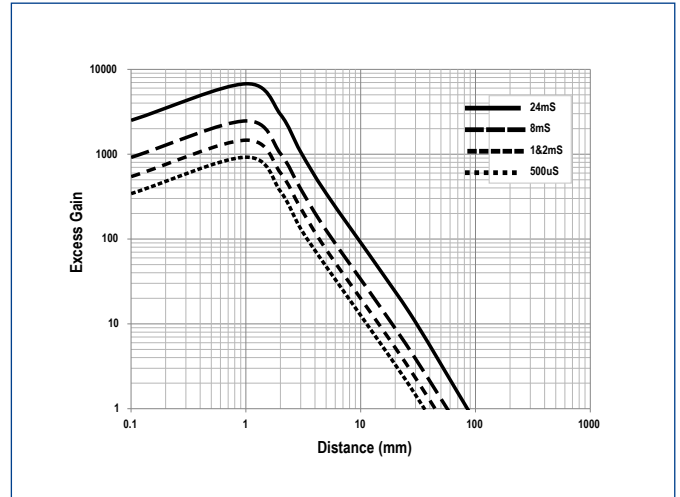

Diffuse proximity with 0.2 mm internal fiber optic diameter

EXCESS GAIN

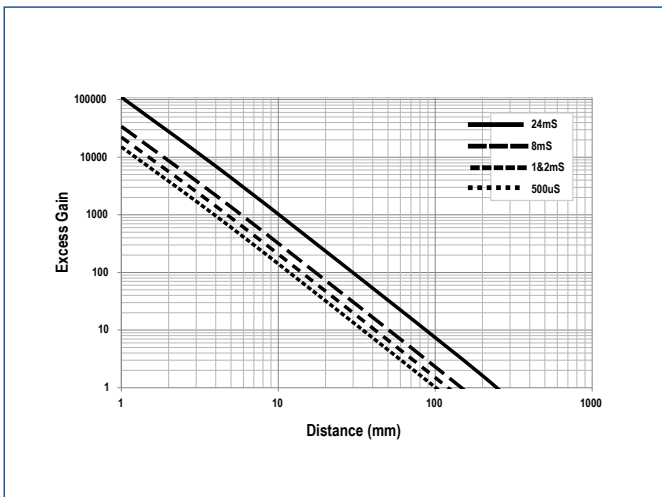

Through beam with 0.5 mm internal fiber optic diameter

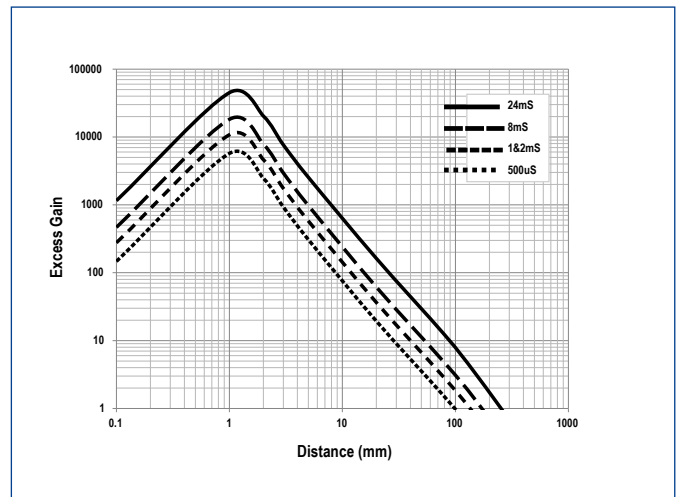

Diffuse proximity with 0.5 mm internal fiber optic diameter

S70-E3

	SUPER HIGH SPEED	HIGH SPEED	FAST	STANDARD	LONG RANGE	EXTRA LONG RANGE
Response Time	-	250 μ s	500 μ s	1 ms	4 ms	12 ms
Repeatability	-	100 μ s	150 μ s	180 μ s	180 μ s	180 μ s

EXCESS GAIN

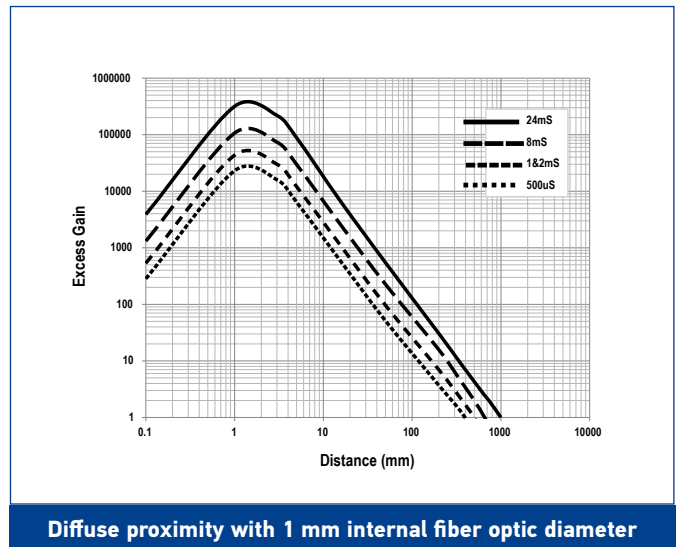
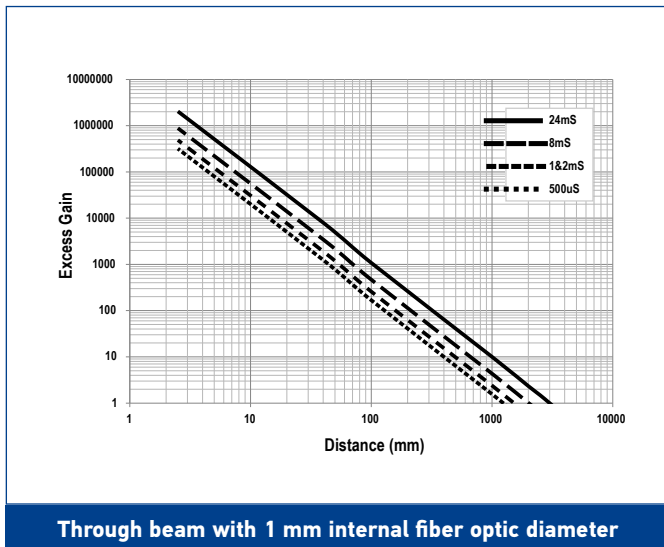

EXCESS GAIN

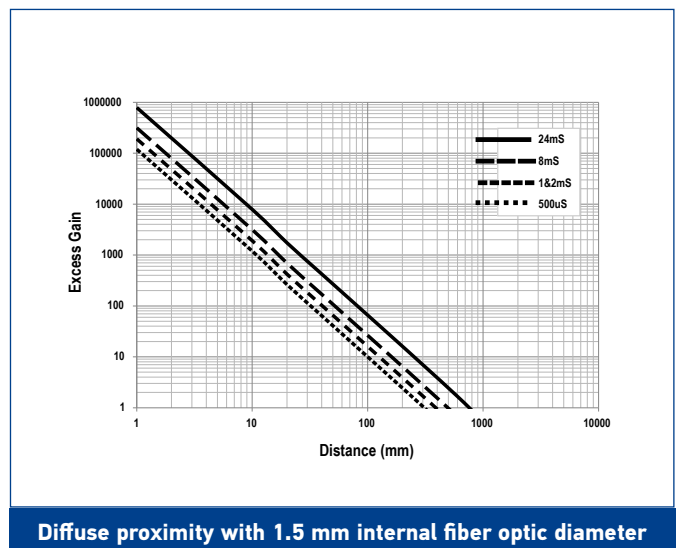
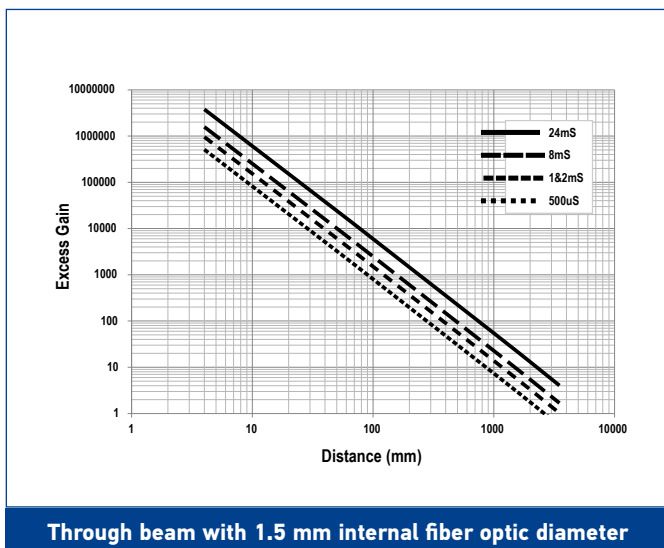

S70-E3

	SUPER HIGH SPEED	HIGH SPEED	FAST	STANDARD	LONG RANGE	EXTRA LONG RANGE
Response Time	-	250 μ s	500 μ s	1 ms	4 ms	12 ms
Repeatability	-	100 μ s	150 μ s	180 μ s	180 μ s	180 μ s

DETECTION AREA

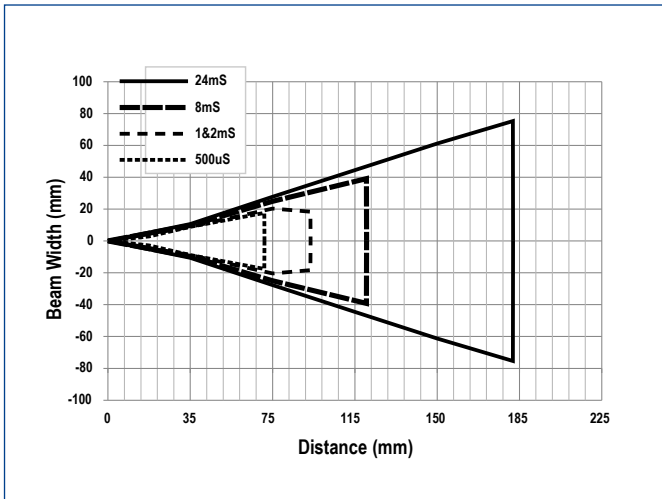

Through beam with 0.2 mm internal fiber optic diameter

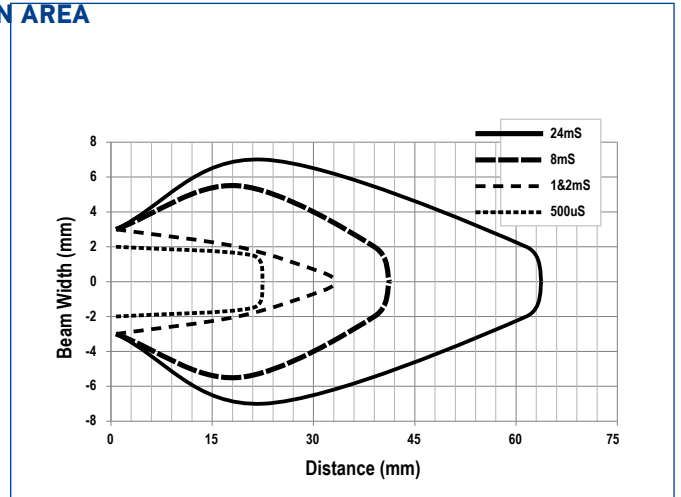

Diffuse proximity with 0.2 mm internal fiber optic diameter

DETECTION AREA

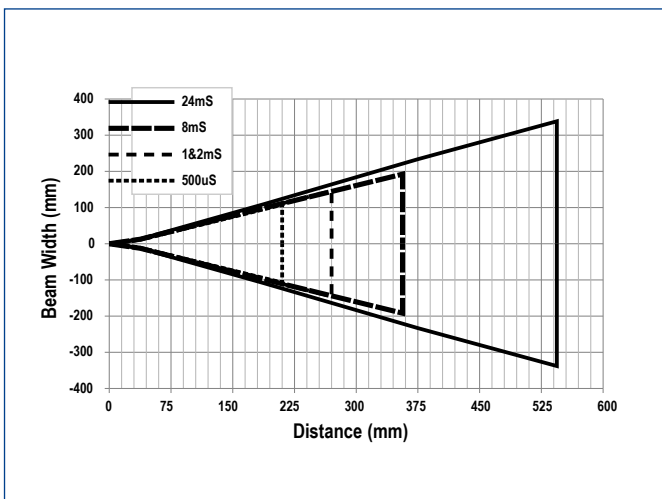

Through beam with 0.5 mm internal fiber optic diameter

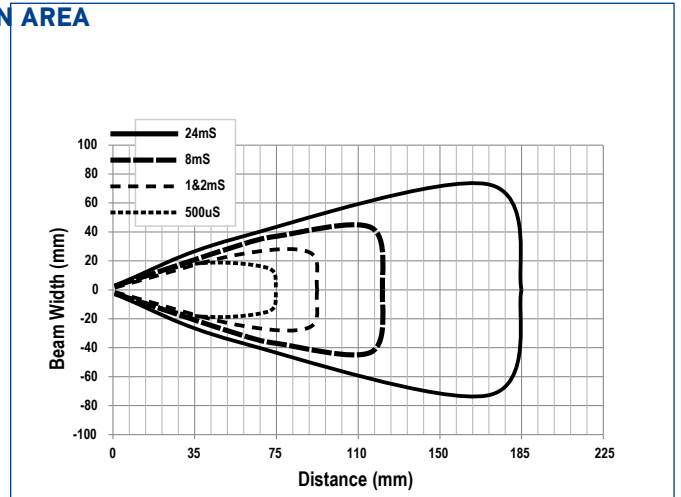

Diffuse proximity with 0.5 mm internal fiber optic diameter

S70-E3

	SUPER HIGH SPEED	HIGH SPEED	FAST	STANDARD	LONG RANGE	EXTRA LONG RANGE
Response Time	-	250 μ s	500 μ s	1 ms	4 ms	12 ms
Repeatability	-	100 μ s	150 μ s	180 μ s	180 μ s	180 μ s

DETECTION AREA

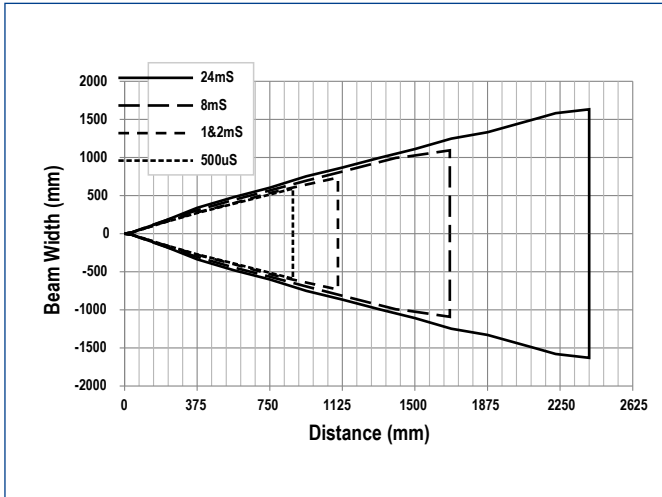

Through beam with 1 mm internal fiber optic diameter

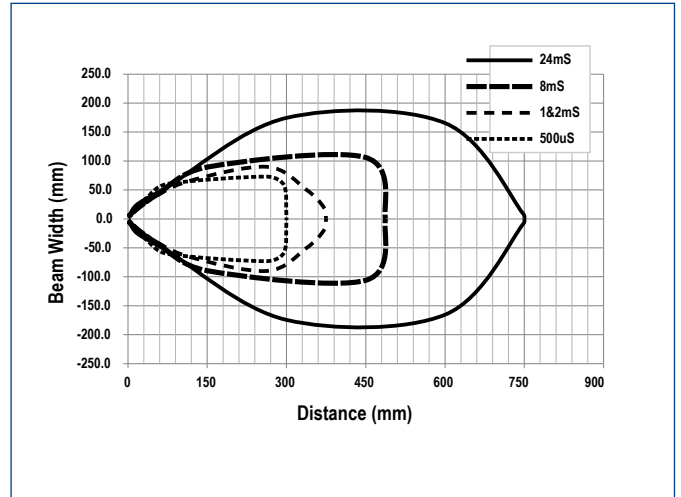

Diffuse proximity with 1 mm internal fiber optic diameter

DETECTION AREA

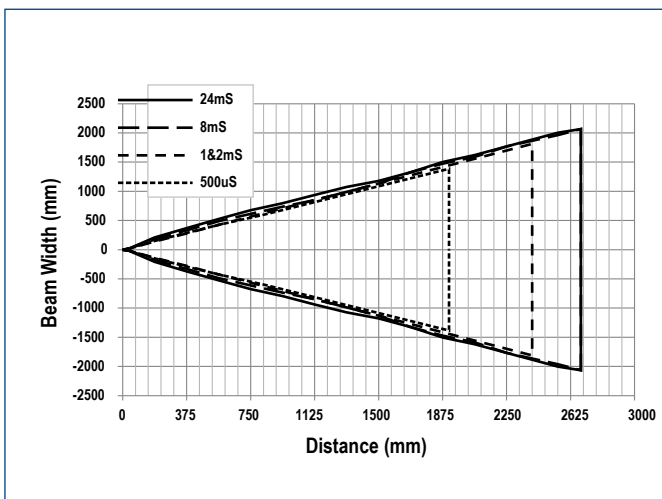

Through beam with 1.5 mm internal fiber optic diameter

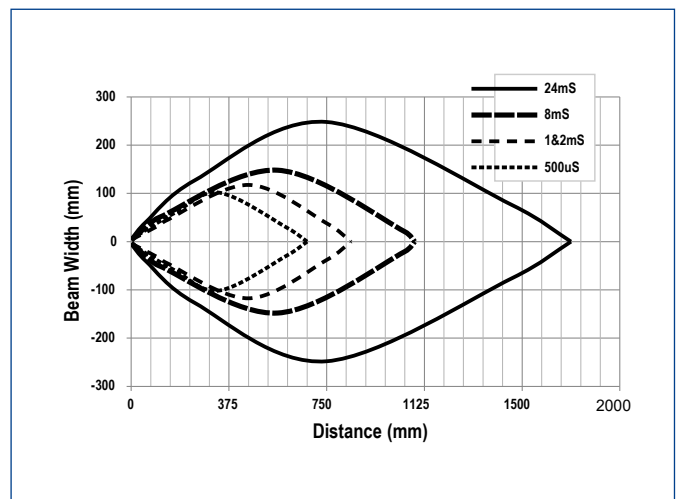

Diffuse proximity with 1.5 mm internal fiber optic diameter

MODEL SELECTION AND ORDER INFORMATION

OPTIC FUNCTION	RESPONSE TIME	CONNECTION	OUTPUT	MODEL	ORDER No.
Fiber Optic Amplifier	200 μ s ... 5 ms	2 m Cable	NPN	S70-2-E1-N	950561000
			PNP	S70-2-E1-P	950561010
		M8 Connector	NPN	S70-5-E1-N	950561060
			PNP	S70-5-E1-P	950561020
			PNP, push-pull IO-Link	S70-5-E1-PZ	950561030
			NPN	S70-5-E2-N	950561040
	10 μ s ... 1 ms	M8 Connector	PNP	S70-5-E2-P	950561050
			4...20mA, NPN	S70-5-E3-NI	950561100
		M8 Connector	0...10V, NPN	S70-5-E3-NV	950561080
			4...20mA, PNP	S70-5-E3-PI	950561090
			0...10V, PNP	S70-5-E3-PV	950561070
			250us...12ms		

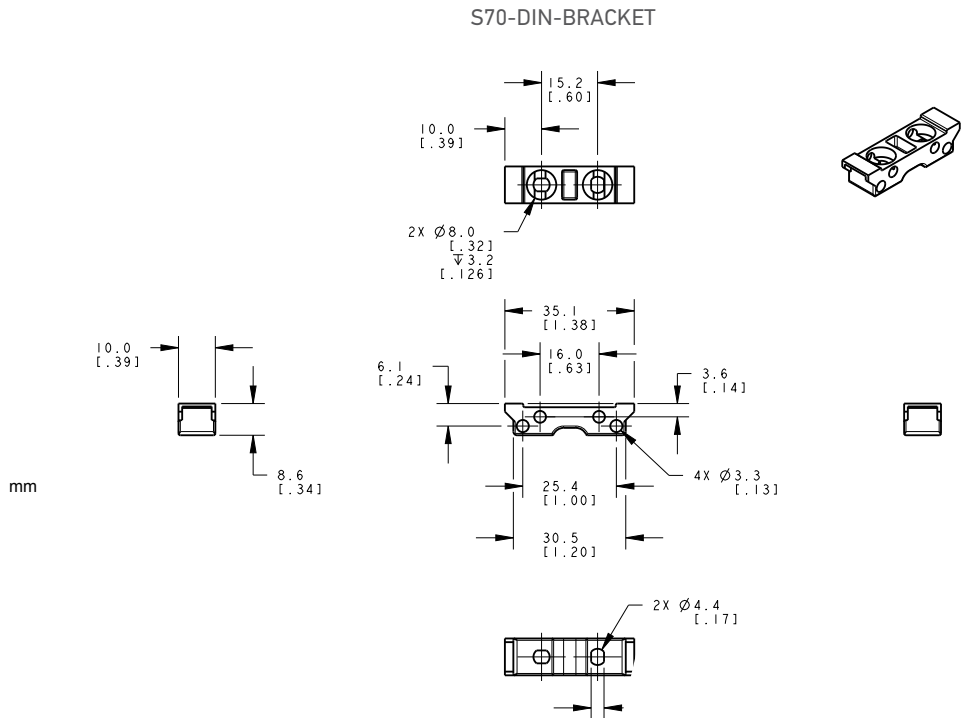
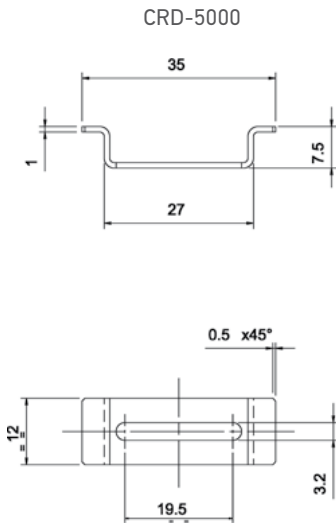

MODEL	DESCRIPTION	ORDER No.
CRD-5000	DIN rail mounting bracket	95ACC2790
S70-DIN-BRACKET	DIN rail mounting plastic bracket	95ACC8170

CABLES

TYPE	DESCRIPTION	LENGTH	MODEL	ORDER No.
Axial M8 Connector	4-pole, grey, P.V.C.	3 m	CS-B1-02-G-03	95A251420
		5 m	CS-B1-02-G-05	95A251430
		7 m	CS-B1-02-G-07	95A251440
		10 m	CS-B1-02-G-10	95A251480
Radial M8 Connector	4-pole, P.U.R.	2 m	CS-B1-02-R-02	95A251620
		5 m	CS-B1-02-R-05	95A251640
	4-pole, grey, P.V.C.	3 m	CS-B2-02-G-03	95A251450
		5 m	CS-B2-02-G-05	95A251460
		7 m	CS-B2-02-G-07	95A251470
		10 m	CS-B2-02-G-10	95A251530
	4-pole, P.U.R.	2 m	CS-B2-02-R-02	95A251630
		5 m	CS-B2-02-R-05	95A251650
Axial M12 Connector	5-pole, L coded power cable	3 m	CS-M1-02-B-03	95ACC0007
Axial M12 F/M8 M Connector	4-pole, double headed	3 m	CS-H1-02-B-03	95ACC0008
Axial M12 F/M12 M Connector	4-pole, double headed	3 m	CS-I1-02-B-03	95ACC0009

OF/OFA SERIES

DATALOGIC

COMPLETE RANGE OF OPTIC FIBERS: UNIVERSAL OR ADVANCED MODELS

- Ultraflexible models
- High temperature models (up to 125 °C)
- Fiber array with parallel beams for proximity or through beam detection
- Fixed focus proximity with axial, radial or lateral optics
- Proximity with 90° optics self-contained
- Focusing, collimating and deviating lenses

APPLICATIONS

- Processing and Packaging machinery
- Electronics assembling
- Pharmaceutical industry
- Cosmetic and bottling industries

OF/OFA

Through beam	Mechanical characteristics, length, diameter of the optic fiber, as well as the switching frequencies, light emitted and resolution of the optic fiber amplifier, affect the operating distances. Refer to the sensor manuals to find the proper operating distance.
Diffuse proximity	
Fixed focus	
OF diameter	Ø2.2 mm or Ø1
OF head	M3, M4, or M6
OFA number of emitted beams	1, 16, 32
Cable lengths	1, 2 m
Operating temperature	-40...+60 °C (OF)
	-40...125 °C (OF-...-HT)
	-30...+70 °C (OFA)
Core material	PMMA plastic
Sheath material	PE plastic
Terminal material	Aluminium (OFA-1/2) ABS (OFA-3/4) Stainless steel (OFA-6)
Mechanical protection	IP67

OF SERIES					
OPTIC FUNCTION	FIBER TYPE	LENGTH	TERMINAL	MODEL	ORDER No.
Through beam	standard	1 m	M4x0.7 mm	OF-19-ST-10	S76021901
	standard	2 m	M4x0.7 mm *	OF-23-ST-20	S76022300
	thin (Ø 1 mm)	1 m	M2x0.4 mm	OF-25-TN-10	S76022500
	standard	2 m	M4x0.7 mm	OF-43-ST-20	95A201350
	high-temperature	2 m	M4x0.7 mm	OF-43-HT-20	95A201280
	ultra-flexible	2 m	M4x0.7 mm	OF-43-UF-20	95A201290
	high-efficiency	2 m	M4x0.7 mm	OF-43-HP-20	95A201300
Proximity	standard	1 m	M6x1 mm	OF-18-ST-10	S76021801
	standard	2 m	M6x1 mm *	OF-22-ST-20	S76022200
	standard	2 m	M4x0.7 mm	OF-24-ST-20	S76022400
	thin (Ø 1 mm)	1 m	M3x0.5 mm	OF-26-TN-10	S76022600
	thin (Ø 1 mm)	1 m	M3x0.5 mm *	OF-28-TN-10	S76022800
	standard	2 m	Ø 3x15 mm	OF-38-ST-20	95A201070
	standard	2 m	M6x0.75 mm	OF-42-ST-20	95A201340
	high-temperature	2 m	M6x0.75 mm	OF-42-HT-20	95A201250
	ultra-flexible	2 m	M6x0.75 mm	OF-42-UF-20	95A201260
	high-efficiency	2 m	M6x0.75 mm	OF-42-HP-20	95A201270
Coaxial proximity	standard	2 m	M6x1 mm	OF-36-ST-20	95A201000
	extra-flexible	2 m	M6x1 mm	OF-36-XF-20	95A201330
	standard	2 m	M4x0.7 mm	OF-44-ST-20	95A201310
	extra-flexible	2 m	M4x0.7 mm	OF-44-XF-20	95A201320

* a bendable stainless steel extension 90mm long protrudes from the threaded optic head



OFA SERIES					
OPTIC FUNCTION	FIBER TYPE	LENGTH	TERMINAL	MODEL	ORDER No.
Through beam	axial, 16 beam array	2 m	15x15 mm	OFA-1-AE-20	95A201170
	radial, 16 beam array	2 m	15x15 mm	OFA-1-AS-20	95A201180
	radial, 16 beam array	2 m	19x38 mm	OFA-3-AS-20	95A201480
Proximity	axial, 32 beam array	2 m	20x20 mm	OFA-2-AE-20	95A201150
	radial, 32 beam array	2 m	20x20 mm	OFA-2-AS-20	95A201160
	radial	2 m	5x65 mm	OFA-6-RA-20	95A201140
Fixed focus proximity	axial	2 m	15x20 mm	OFA-4-FE-20	95A201200
	lateral	2 m	15x20 mm	OFA-4-FF-20	95A201210
	radial	2 m	15x20 mm	OFA-4-FS-20	95A201190



OF ACCESSORIES			
DESCRIPTION	SUITABLE FIBERS	MODEL	CODE N°
2 pcs 90° deviating lenses	OF-43-XX	AF-1	95ACC2690
2 pcs long distance collimating lenses (x 4)	OF-43-XX	AF-2	95ACC2700
1 pc focusing lens with 4 mm resolution	OF-44-XX	AF-3	95ACC2710
1 pc focusing lens with 0.4 mm resolution	OF-44-XX	AF-4	95ACC2720
2 pcs adapters Ø 2.2 mm for thin Fibers	OF-XX-TN	AF-5	95ACC2730
1 pc metal sheath for M6 x 0.75 Fibers	OF-42-XX	AF-7	95ACC2750
1 pc metal sheath for M4 x 07 Fibers	OF-43-XX (*)	AF-9	95ACC2770
Fiber-cutting tool with Ø 2.2 mm and Ø 1.1 mm holes	ALL	AF-11	95ACC2780

* 2 sheaths have to be ordered for both the emitter-receiver sections

OF SERIES

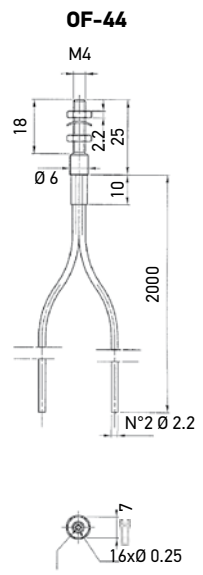
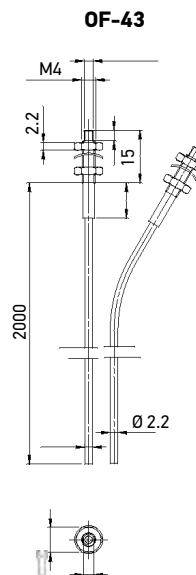
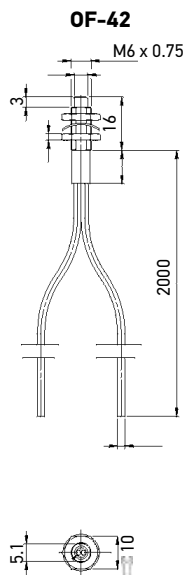
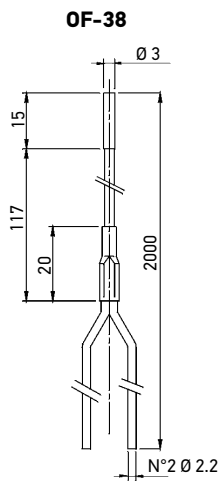
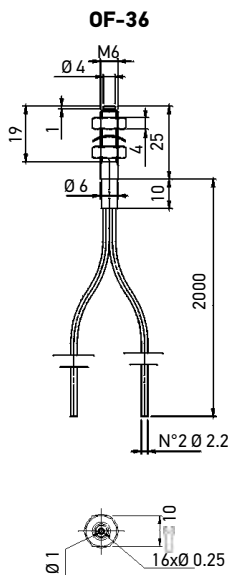
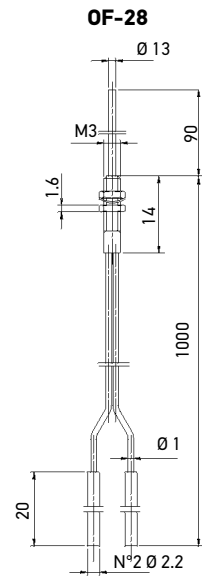
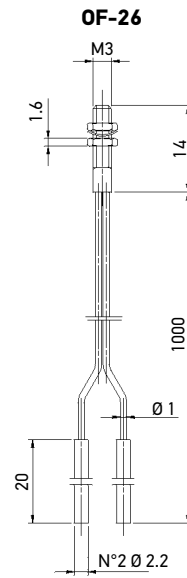
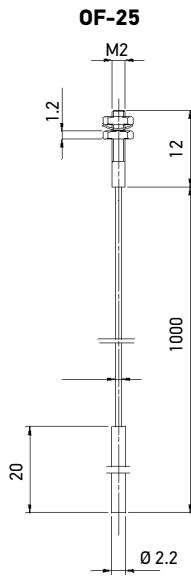
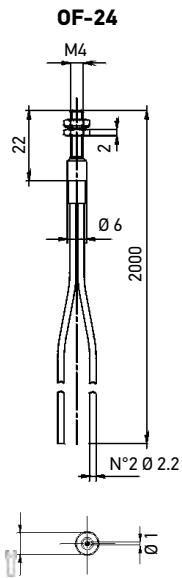
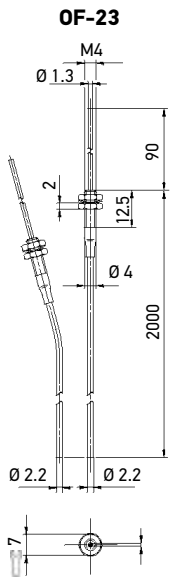
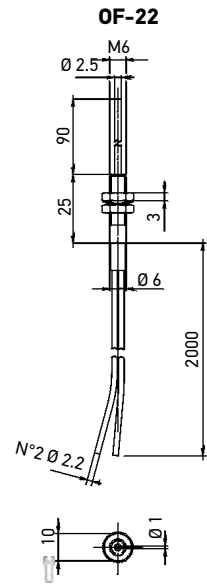
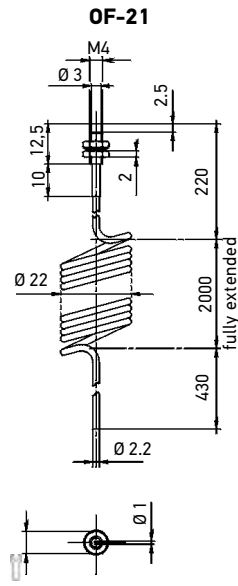
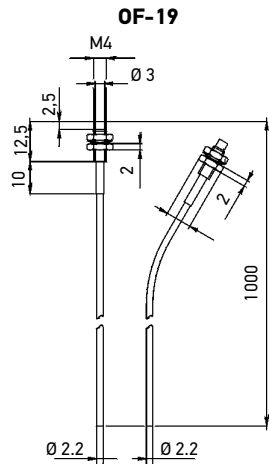
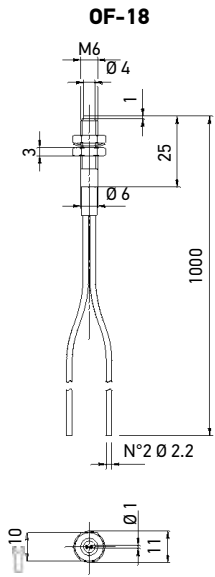

mm

OFA SERIES

OFA-1-AE-20

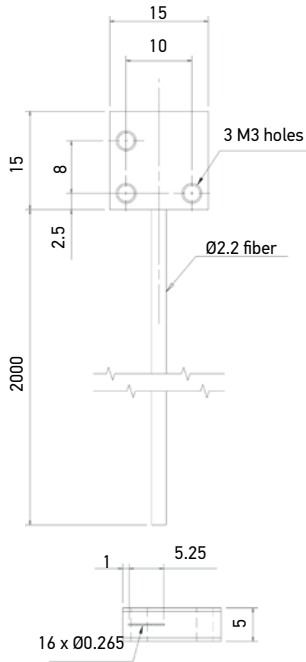

OFA-1-AS-20

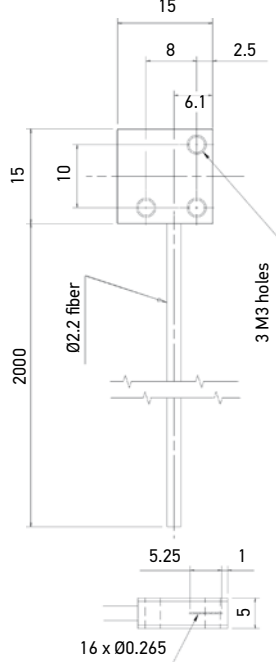

OFA-2-AE-20

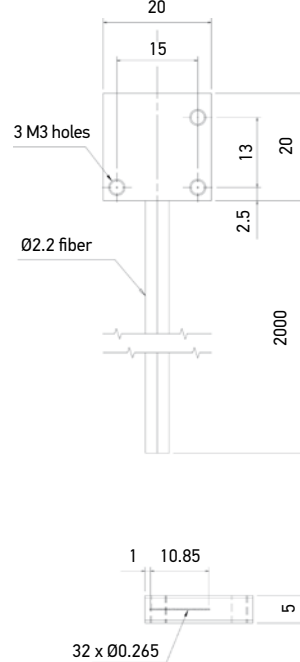

OFA-2-AS-20

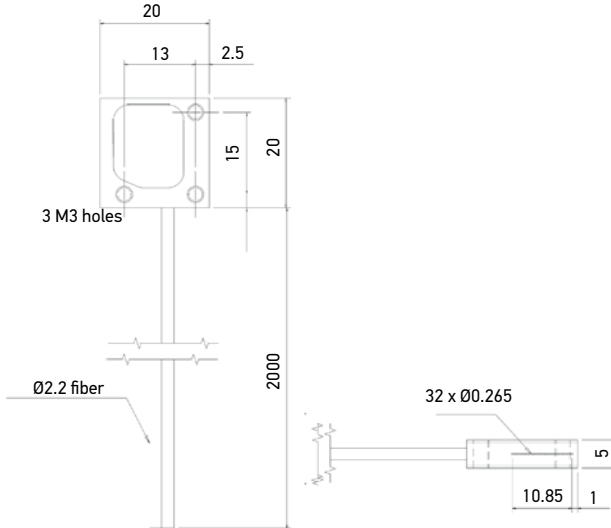

OFA-3-AS-20

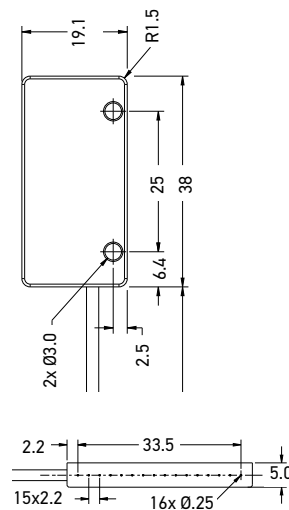

OFA-4-FE-20

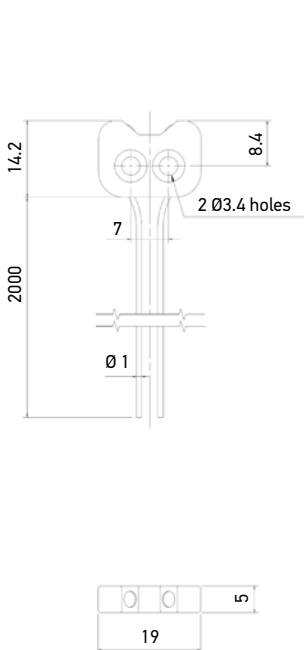

OFA-4-FF-20

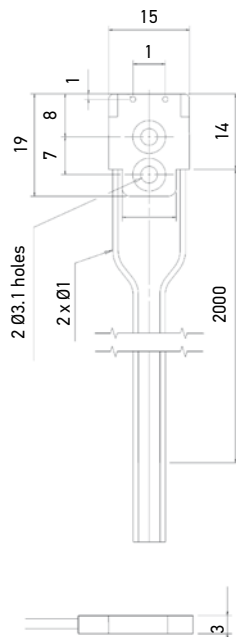

OFA-4-FS-20

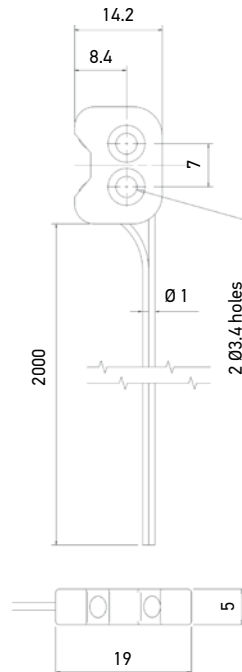

OFA-6-RA-20

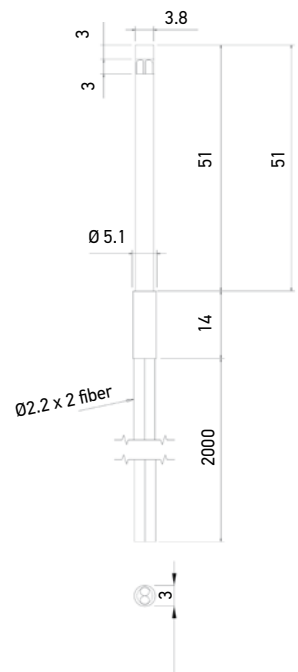

DETECTION DIAGRAMS

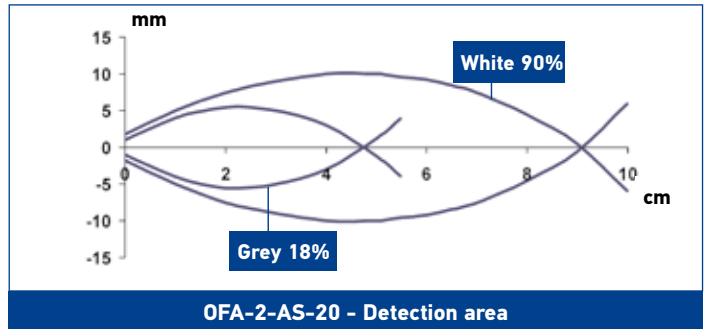
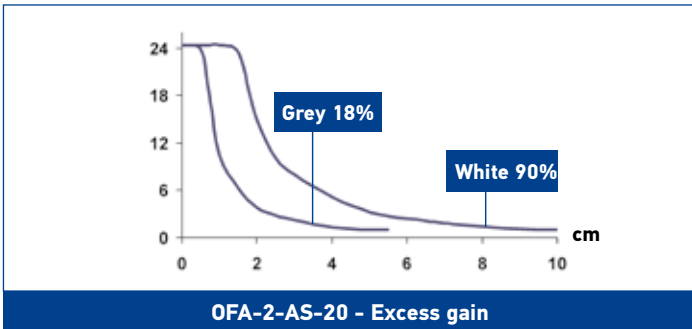
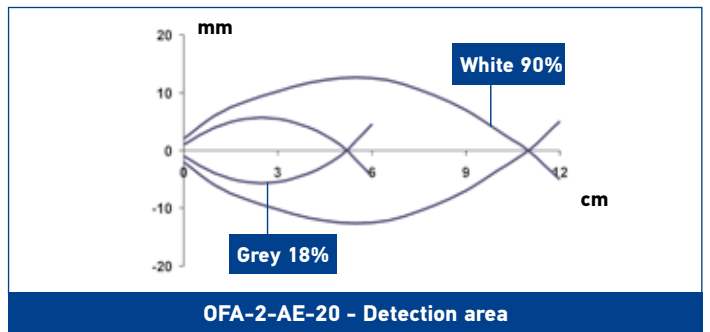
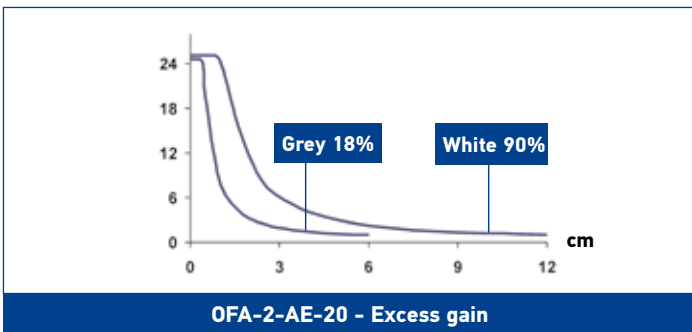
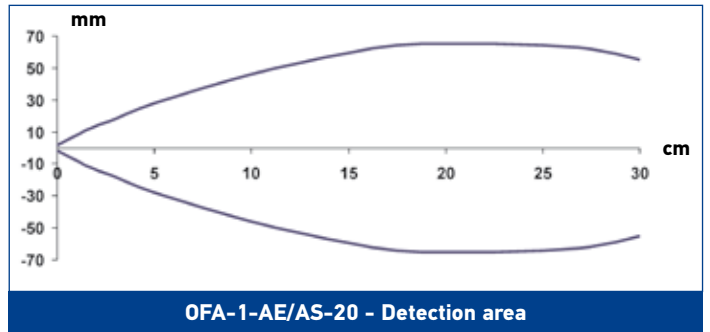
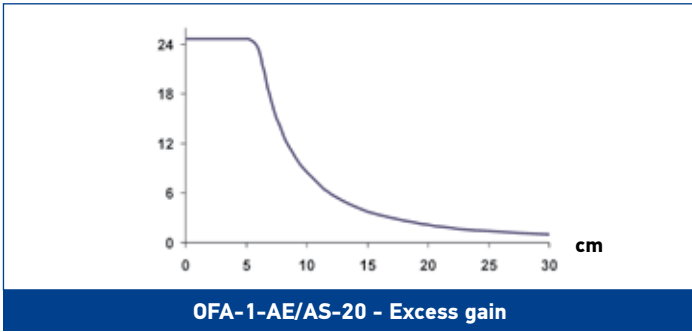

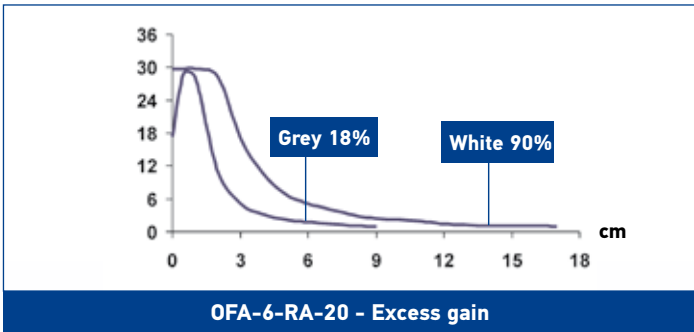
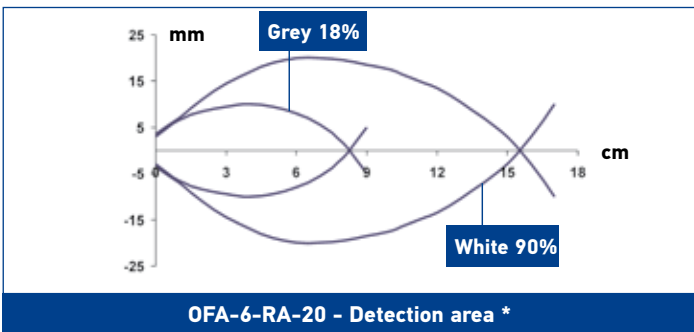
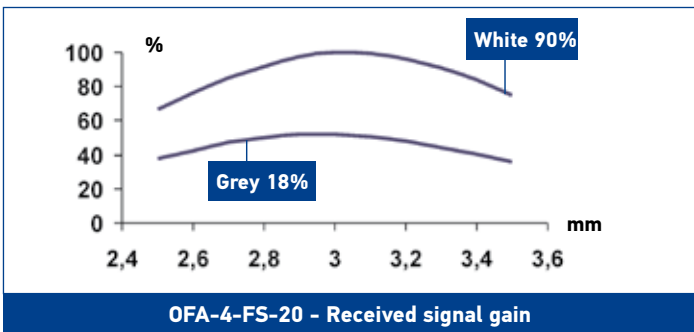
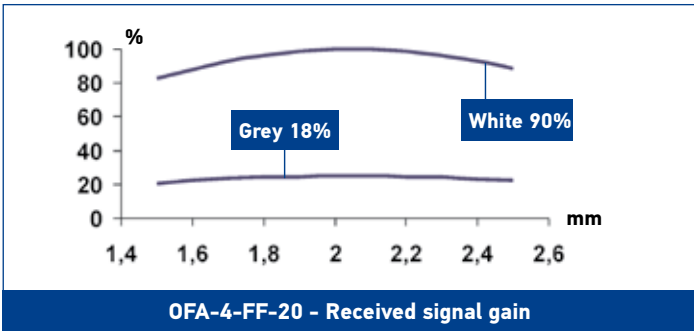
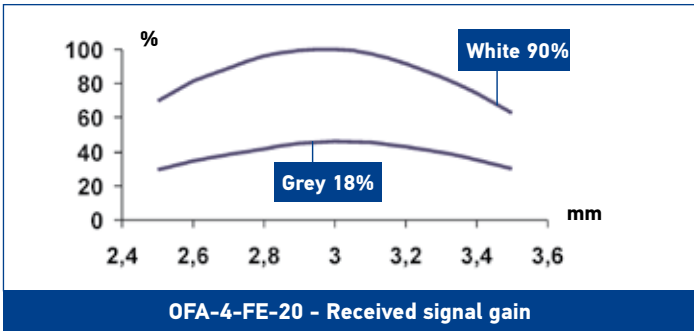

S8



IO-Link^(*)
New ASIC

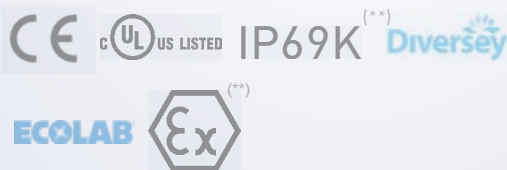

COMPACT SIZE AND HIGH PERFORMANCE FOR THE MOST CHALLENGING DETECTION APPLICATIONS LINKED TO YOUR INDUSTRY 4.0 APPLICATIONS

- Compact dimensions (14x42x25 mm)
- Background suppression for transparent and shiny objects
- Contrast sensors up to 25 kHz switching frequency
- Extremely focused spot, under 1 mm (LASER model)
- Very high resolution LASER models
- INOX AISI 316L model
- Extended IO-Link parametrization with counter
- All output fully PNP/NPN/PP IO-Link configurable
- IO-link COM2
- IO-Link dual channel with no jitter addition

APPLICATIONS

- Processing and Packaging machinery
- Beverage/Food/ Cosmetics/Pharmaceutical industries
- Electronics assembling

(**) Stainless steel models.
ATEXII 3DG

S8		
Through beam	0...25 m	
Polarized retroreflective	0,1...5 m	
Polarized retroreflective (coaxial)	0...10 m (class 1 LASER - B51,B53...OZ)	
Retroreflective for transparent (coaxial)	0...0,8 m (T51), 0...2 m (T53...OZ, T50)	
Diffuse proximity	0...500 mm	
Background suppression	50...300 mm	
Background suppression for clear detection	20...200 mm (class 1 LASER)	
	100...300 mm (LED)	
	50...150 mm (class 1 LASER)	
Contrast sensor	10 mm (Wxx, W03...OZ)	
Luminescence sensor	10...30 mm (U03, U03...OZ)	
Power supply	Vdc	12...30 V
	Vac	
	Vac/dc	
Output	PNP	•
	NPN	•
	NPN/PNP	IO-Link PNP/NPN/Push Pull (S8...B53/T53/W03/U03...OZ)
	relay	
	other	IO-Link dual channel COM2 2,3ms cycle time
Connection	cable	•
	connector	•
	pig-tail	•
Approximate dimensions (mm)	14x42x25	
Housing material	ABS, Stainless Steel AISI 316L	
Mechanical protection	IP69K (Stainless Steel AISI 316L vers.), IP67	

TECHNICAL DATA

Power supply	12 ... 30 Vdc (battery inversion protected)
Ripple	2 Vpp max.
Consumption (output current excluded)	30 mA; 35 mA (mod. S8...M01); 20 mA (mod. S8...F), 15 mA (mod. S8...G) max.; 40mA max. all IO-Link Models red LED 660 nm (mod. S8...B01/C/M/G/T)
Light emission	RGB LEDs: blue 465 nm, green 520 nm, red 630nm with automatic selection (mod. S8...W)
	UV LED 375 nm (mod. S8...U)
	red Laser 645..665 nm (mod. S8...B51/B53/M) Class 1
Sensitivity Setting	8-turn distance adjustment trimmer (mod. S8...M53/M)
	teach-in push button (mod. S8...B53/B53...OZ/M53/W03/W03...OZ/W13/T53/T53...OZ/U03/U03...OZ)
	remote input (mod. S8...M53)
	mono-turn trimmer (mod. S8...B01/C/F/M/T51)
Operating mode	automatic auto adjustment (mod. S8...W/T50)
	remote input (mod. S8...M53)
	LIGHT / DARK mono-turn trimmer (mod. S8...B/C/F/T51/T53/U)
Indicators	yellow OUTPUT LED (all models excl. mod. S8...G), OUTPUT/ALARM LED (mod. S8...M53/M/C) green POWER LED
Output	PNP or NPN N.O. ; PNP/NPN/Push Pull fully configurable outputs for all IO-Link models (S8...B53/T53/W03/U03...OZ)
Output current	100 mA (overload protection and short circuit)
Saturation voltage	2 V max.
Response time	1 ms (mod. S8...M53/M)
	500 µs (mod. S8...B/F/C)
	250 µs (mod. S8...T/T53...OZ IO-Link)
	100 µs (Laser vers. mod. S8...M)
	50 µs (mod. S8...W00/W03/W03...OZ IO-Link and Laser mod. S8...B51/B53...OZ IO-Link)
	20 µs (mod. S8...W13)
	250 µs... 1 ms (mod. S8...U) and U03...OZ IO-Link
Switching frequency	500 Hz (mod. S8...M53/M)
	1 kHz (mod. S8...B/F/C)
	2 kHz (mod. S8...T/T53...OZ IO-Link)
	5 kHz (Laser vers. mod. S8...M)
	10kHz (mod. S8...W00/W03/W03...OZ IO-Link and Laser mod. S8...B51/B53...OZ IO-Link)
	25 kHz (mod. S8...W13)
	500 Hz... 2 kHz (mod. S8...U) and U03...OZ IO-Link
	IO-Link COM2 V1.1.2 2,3ms cycle time
Communication	
Connection	M8 4-pole connector, 150 mm length Ø 4 mm cable with M12 4-pole connector (pig-tail vers.)
Dielectric strength	1500 VAC 1 min between electronic parts and housing
Insulating resistance	>20 MΩ 500 VDC between electronic parts and housing
Mechanical protection	IP67, IP69K (mod. S8-M)
Ambient light rejection	according to EN 60947-5-2
Vibrations	0.5 mm amplitude, 10 ... 55 Hz frequency, for every axis (EN60068-2-6)
Shock resistance	11 ms (30 G) 6 shocks per every axis (EN60068-2-27)
Housing material	ABS, Stainless Steel AISI 316L
Optical window material	window in PMMA; lens in PC
Operating temperature	-10 ... 55 °C
Storage temperature	-20 ... 70 °C
Weight	12 g max. conn. vers., 50 g pig-tail vers., 70 g max. (mod. S8-M)

CONNECTIONS

STANDARD MODELS

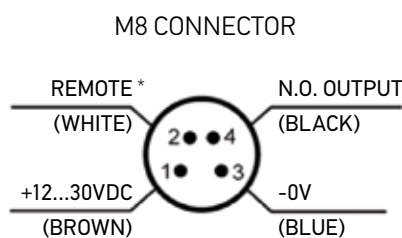
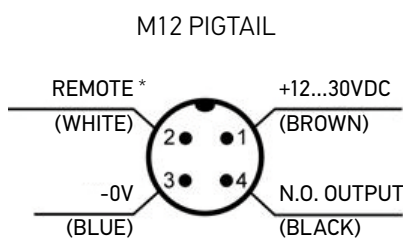

IO-LINK MODELS (M8 CONNECTOR ONLY)

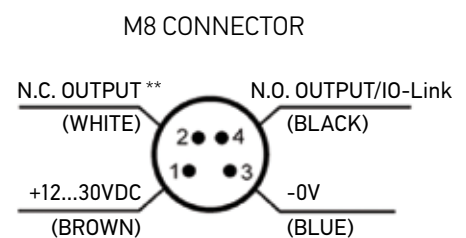

* REMOTE INPUT (mod. S8...W, U, T50, T53), LIGHT / DARK INPUT (mod. S8...M53), DELAY (mod. S8...M Laser), TEST INPUT (mod. S8...G), ALARM OUTPUT (mod. S8...B, T51), NOT USED (mod. S8...C, M, F)

** Fully configurable I/O Pin input or output by IO-Link setting

DIMENSIONS

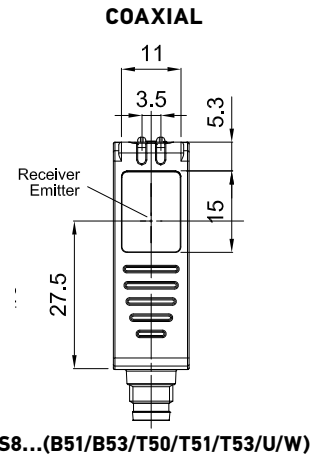
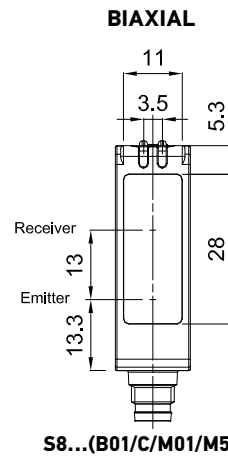
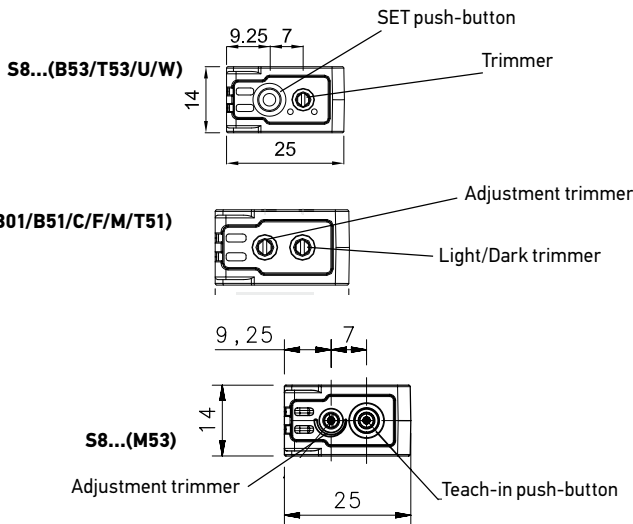
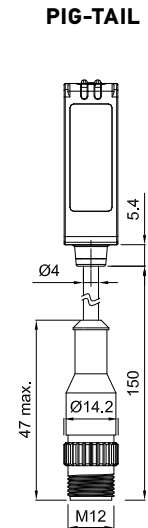
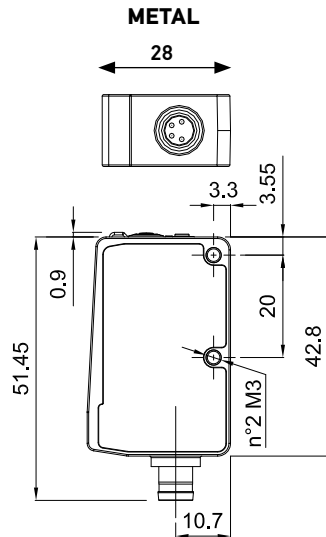
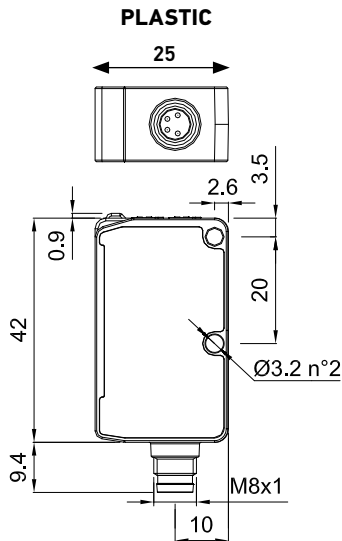

Note : T50 has no settings, only indicators

INDICATOR AND SETTING

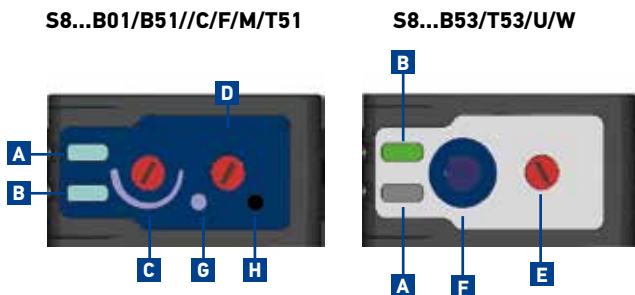

- A** Output status LED
- B** Ready LED or Power ON LED
- C** Sensitivity adjustment trimmer
- D** Dark/light trimmer

- E** Delay trimmer
- F** SET push-button
- G** Light
- H** Dark

Note : T50 has no settings, only indicators

READING DIAGRAMS

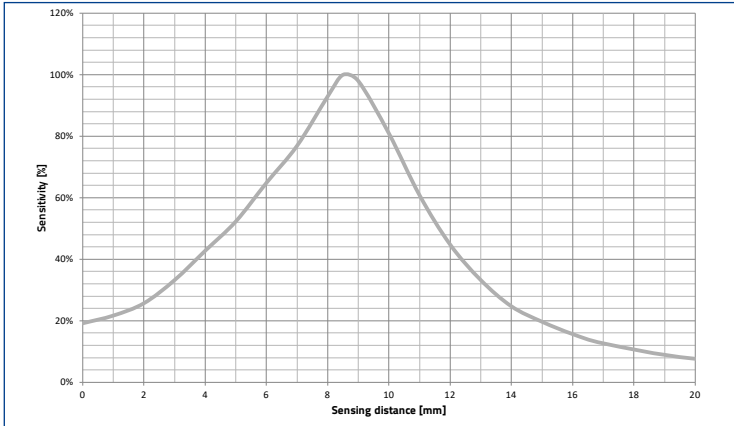

Contrast sensor (W00, W03...OZ, W13)

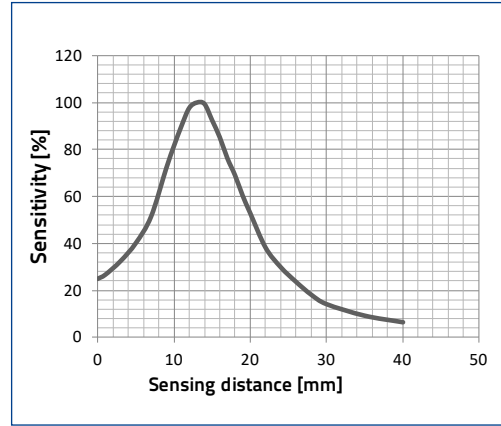

Luminescence sensor (U03...OZ)

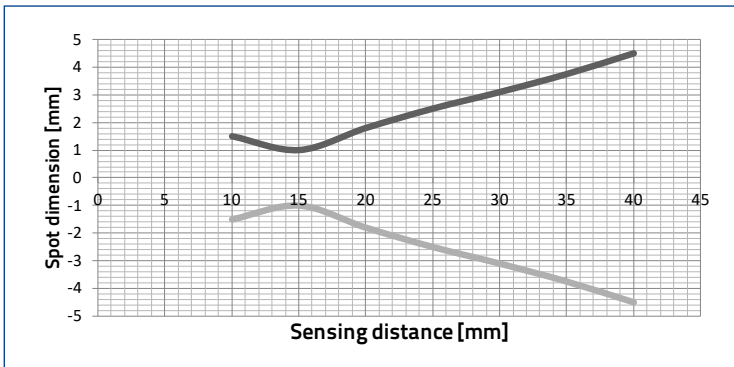

Luminescence sensor (U03/U03...OZ)

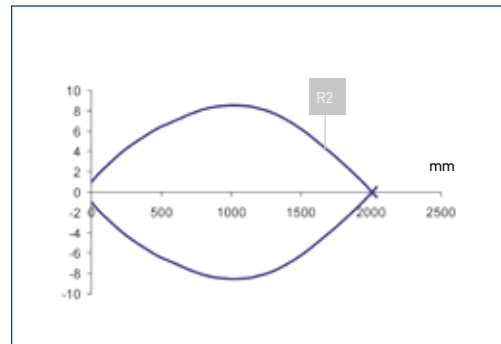

Coaxial Polarized Retroreflective for Transparents (T50/T53/T53...OZ)

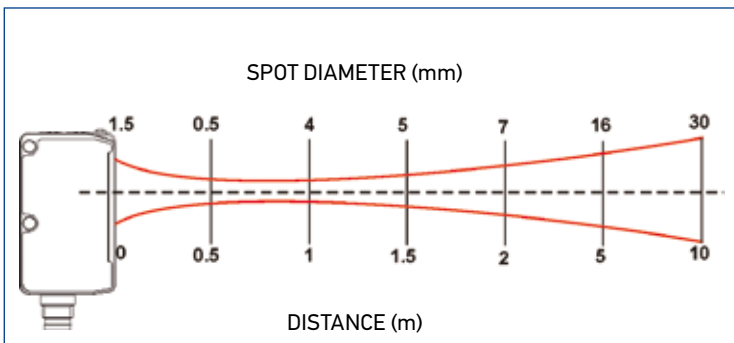

Spot Diameter Polarized Retroreflective Coaxial (LASER/B51/B53...OZ)

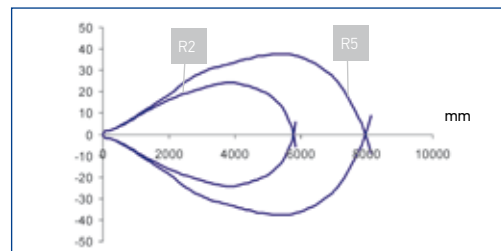

Polarized Retroreflective (LED/B01)

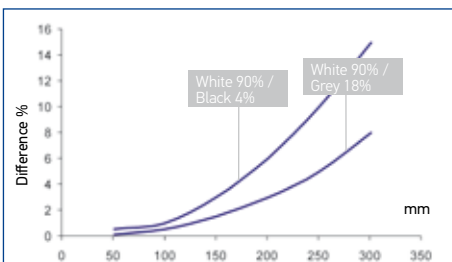

Background suppression (LED/M01)

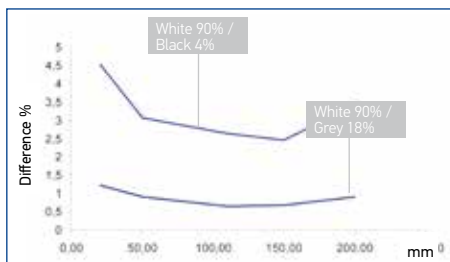

Background suppression (LASER/M01)

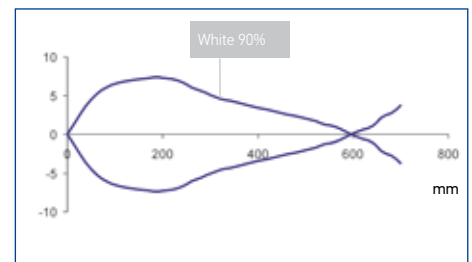

Diffuse Proximity (C01)

MODEL SELECTION AND ORDER INFORMATION

CLEAR DETECTION						
HOUSING	OPTIC TYPE	LIGHT EMISSION	CONNECTION	OUTPUT	MODEL	ORDER NO.
METAL Stainless Steel (INOX AISI 316L)	Axial	LASER	M8 connector	PNP	S8-MH-5-M53-PP	950801451
		LED			S8-MR-5-M53-PP	950801600
LASER		S8-PH-5-M53-PP			950801381	
LED		S8-PR-5-M53-PP			950801590	
PLASTIC ABS						

RETROREFLECTIVE FOR TRSPARENT						
HOUSING	OPTIC TYPE	LIGHT EMISSION	CONNECTION	OUTPUT	MODEL	ORDER NO.
METAL Stainless Steel (INOX AISI 316L)	Coaxial	LED	M8 connector	NPN	S8-MR-5-T50-NH	950801330
				PNP	S8-MR-5-T50-PH	950801320
			M8 connector	NPN	S8-MR-5-T53-NN	950801310
				PNP	S8-MR-5-T53-PP *	950801300
PLASTIC ABS			pig-tail	NPN	S8-PR-3-T51-NN	950801130
				PNP	S8-PR-3-T51-PP	950801120
			M8 connector	PNP/NPN/Push Pull	S8-PR-5-T53-OZ	950800005
					 IO-Link	
	M8 connector	NPN	S8-PR-5-T51-NN	950801050		
		PNP	S8-PR-5-T51-PP	950801040		
M8 connector	NPN	S8-PR-5-T53-NN	950801290			
			PNP	S8-PR-5-T53-PP *	950801280	

*Note: With Auto adaptive function

POLARIZED RETROREFLECTIVE						
HOUSING	OPTIC TYPE	LIGHT EMISSION	CONNECTION	OUTPUT	MODEL	ORDER NO.
METAL Stainless Steel (INOX AISI 316L)	Coaxial	LASER	M8 connector	NPN	S8-MH-5-B51-NN	950801490
				PNP	S8-MH-5-B51-PP	950801480
	Axial	LED		NPN	S8-MR-5-B01-NN	950801420
				PNP	S8-MR-5-B01-PP	950801410
PLASTIC ABS	Coaxial	LASER	pig-tail	NPN	S8-PH-3-B51-NN	950801090
				PNP	S8-PH-3-B51-PP	950801080
			M8 connector	NPN	S8-PH-5-B51-NN	950801010
				PNP	S8-PH-5-B51-PP	950801000
	Axial	LED	pig-tail	PNP/NPN/Push Pull	S8-PH-5-B53-OZ	950800006
					 IO-Link	
			M8 connector	NPN	S8-PR-3-B01-NN	950801190
				PNP	S8-PR-3-B01-PP	950801180
			NPN	S8-PR-5-B01-NN	950801170	
			PNP	S8-PR-5-B01-PP	950801160	

BACKGROUND SUPPRESSION							
HOUSING	OPTIC TYPE	LIGHT EMISSION	CONNECTION	OUTPUT	MODEL	ORDER NO.	
METAL Stainless Steel (INOX AISI 316L)	Axial	LASER	M8 connector	NPN	S8-MH-5-M01-NN	950801470	
				PNP	S8-MH-5-M01-PP	950801460	
		LED		NPN	S8-MR-5-M01-NN	950801400	
				PNP	S8-MR-5-M01-PP	950801390	
PLASTIC ABS		LASER	pig-tail	M8 connector	NPN	S8-PH-3-M01-NN	950801110
					PNP	S8-PH-3-M01-PP	950801100
			M8 connector	NPN	S8-PH-5-M01-NN	950801030	
				PNP	S8-PH-5-M01-PP	950801020	
	LED	pig-tail	M8 connector	NPN	S8-PR-3-M01-NN	950801230	
				PNP	S8-PR-3-M01-PP	950801220	
		M8 connector	NPN	S8-PR-5-M01-NN	950801210		
			PNP	S8-PR-5-M01-PP	950801200		

THROUGH BEAM						
HOUSING	OPTIC TYPE	LIGHT EMISSION	CONNECTION	OUTPUT	MODEL	ORDER NO.
METAL Stainless Steel (INOX AISI 316L)	Axial	LED	M8 connector	NPN	S8-MR-5-F01-NN	950801570
				PNP	S8-MR-5-F01-PP	950801560
emitter				S8-MR-5-G00-XG	950801580	
PLASTIC ABS			pig-tail	NPN	S8-PR-3-F01-NN	950801530
				PNP	S8-PR-3-F01-PP	950801520
				emitter	S8-PR-3-G00-XG	950801550
M8 connector			NPN	S8-PR-5-F01-NN	950801510	
			PNP	S8-PR-5-F01-PP	950801500	
			emitter	S8-PR-5-G00-XG	950801540	

DIFFUSE						
HOUSING	OPTIC TYPE	LIGHT EMISSION	CONNECTION	OUTPUT	MODEL	ORDER NO.
METAL Stainless Steel (INOX AISI 316L)	Axial	LED	M8 connector	NPN	S8-MR-5-C01-NN	950801440
				PNP	S8-MR-5-C01-PP	950801430
pig-tail			NPN	S8-PR-3-C01-NN	950801270	
			PNP	S8-PR-3-C01-PP	950801250	
M8 connector			NPN	S8-PR-5-C01-NN	950801260	
			PNP	S8-PR-5-C01-PP	950801240	

CONTRAST (RGB LED EMISSION LIGHT)							
HOUSING	OPTIC TYPE	SWITCHING FREQUENCY	CONNECTION	OUTPUT	MODEL	ORDER NO.	
METAL Stainless Steel (INOX AISI 316L)	Coaxial	10 kHz	M8 connector	PNP	S8-MR-5-W00-PH *	950801360	
				NPN	S8-MR-5-W00-NH *	950801370	
				PNP	S8-MR-5-W03-PP	950801340	
				NPN	S8-MR-5-W03-NN	950801350	
PLASTIC ABS			M12 pig-tail (150 mm)	PNP	S8-PR-3-W03-PP	950801140	
				NPN	S8-PR-3-W03-NN	950801150	
				PNP	S8-PR-5-W03-PP	950801060	
				NPN	S8-PR-5-W03-NN	950801070	
METAL Stainless Steel (INOX AISI 316L)		M8 connector	25 kHz	PNP/NPN/Push Pull 	S8-PR-5-W03-OZ	950800004	
					PNP	S8-MR-5-W13-PP	950801670
					NPN	S8-MR-5-W13-NN	950801680
					PNP	S8-PR-5-W13-PP	950801650
PLASTIC ABS	M12 pig-tail (150 mm)	NPN		S8-PR-5-W13-NN	950801660		
		PNP		S8-PR-3-W13-PP	950801690		
		NPN		S8-PR-3-W13-NN	950801700		

*Note: Without regulation

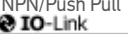
LUMINESCENCE (UV LED EMISSION LIGHT)							
HOUSING	OPTIC TYPE	SETTINGS	CONNECTION	OUTPUT	MODEL	ORDER NO.	
METAL Stainless Steel (INOX AISI 316L)	Coaxial	Teach-in push-button; L/D trimmer selector; Remote Input	M8 connector	PNP	S8-MR-5-U03-PP	950801630	
				NPN	S8-MR-5-U03-NN	950801640	
PNP				S8-PR-5-U03-PP	950801610		
NPN				S8-PR-5-U03-NN	950801620		
PLASTIC ABS			pig-tail	PNP/NPN/Push Pull 	PNP	S8-PR-5-U03-OZ	950800007
					PNP	S8-PR-3-U03-PP	950801710
					NPN	S8-PR-3-U03-NN	950801720

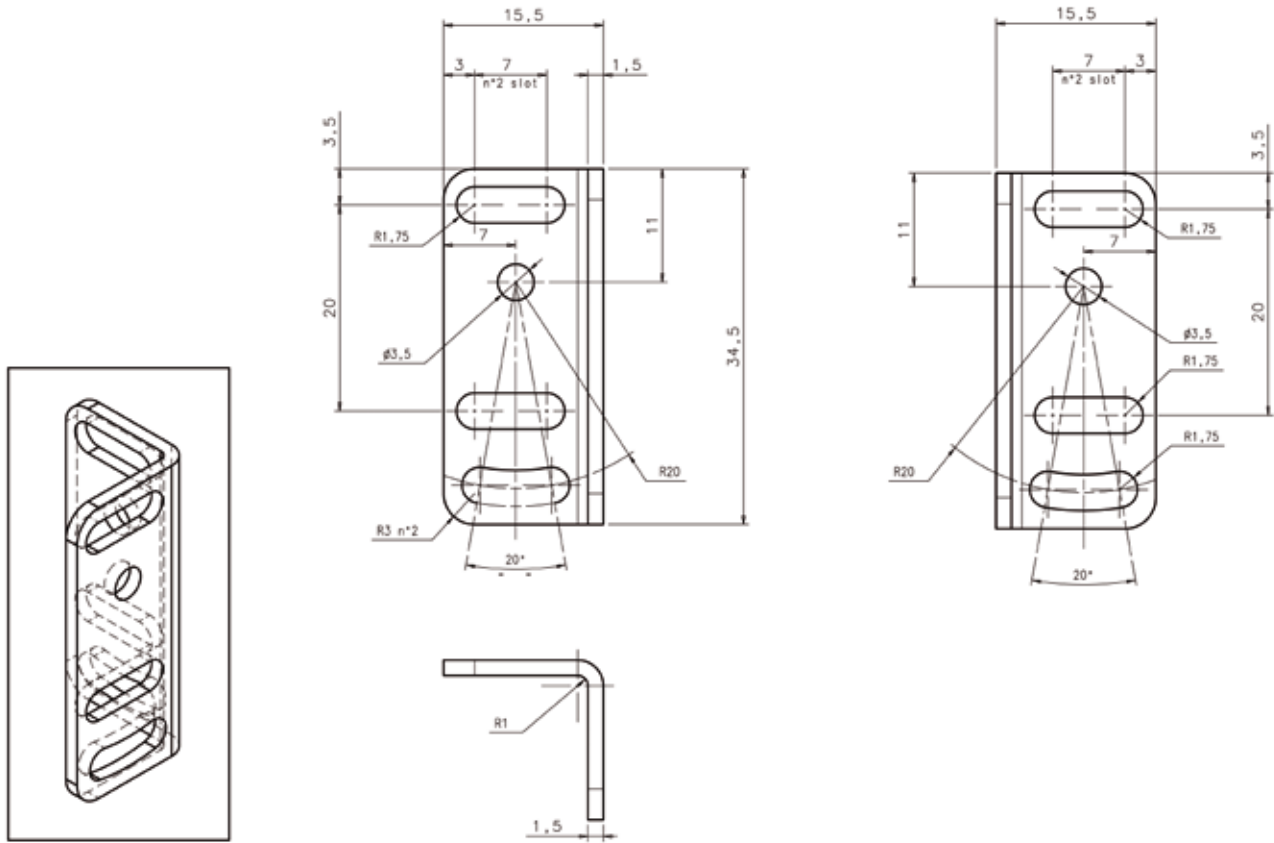

MODEL	FUNCTION	ORDER No.
ST-S8-FRM	mounting bracket for standard frame	95ACC7860
ST-5072	mounting bracket	95ACC1470
R4K	IP69K plastic reflector 51 x 61 mm	95A151220
ST-S8-TL-LD46	TL-LD46 adapting bracket	95ACC3430
ST-S8-S3Z	S8-miniature sensors adapting bracket	95ACC3440
ST-0387	Adapter bracket S8/S41	95ACC3410

IO-LINK CONNECTIVITY		
MODEL	DESCRIPTION	ORDER No.
CBX-8IOL-EIP	CBX-8IOL-EIP 8P IOL M12 EIP MASTER	95ACC8180
CBX-8IOL-PNIO	CBX-8IOL-PNIO 8P IOL M12 PROFINET MASTER	95ACC8190

CABLES

TYPE	DESCRIPTION	LENGTH	MODEL	ORDER No.
Axial M8 Connector	4-pole, grey, P.V.C.	3 m	CS-B1-02-G-03	95A251420
		5 m	CS-B1-02-G-05	95A251430
		7 m	CS-B1-02-G-07	95A251440
		10 m	CS-B1-02-G-10	95A251480
	4-pole, P.U.R.	2 m	CS-B1-02-R-02	95A251620
		5 m	CS-B1-02-R-05	95A251640
Radial M8 Connector	4-pole, grey, P.V.C.	3 m	CS-B2-02-G-03	95A251450
		5 m	CS-B2-02-G-05	95A251460
		7 m	CS-B2-02-G-07	95A251470
		10 m	CS-B2-02-G-10	95A251530
	4-pole, P.U.R.	2 m	CS-B2-02-R-02	95A251630
		5 m	CS-B2-02-R-05	95A251650
Axial M12-M/M8-F Double Headed Connector	4-pole, PVC IO-Link	3 m	CS-H1-02-B-03	95ACC0008

S300 PA



ADVANCED MAXI PHOTOELECTRIC MULTIVOLTAGE SENSORS

- Industrial plastic housing with IP67 mechanical protection
- Timing function from 0.6-16 s ON delay, OFF delay and ONE SHOT
- Terminal block for both Vdc and Vac/ Vdc free voltage
- Distance trimmer for mechanical background suppression models

APPLICATIONS

- Packaging end of line, palletizers
- Outdoor or indoor gates control
- Manufacturing plants



(*)DC models:
ATEX II 3DG

S300 PA		
Through beam	0...50 m	
Retroreflective (on R2 reflector)	0,1...15 m	
Polarized retroreflective	0,1...10 m	
Diffuse proximity	0,05...2 m	
Background suppression	0,2...2 m	
Power supply	Vdc	12...30 V
	Vac	
	Vac/dc	24...240 Vac/24...60 Vdc
Output	PNP	
	NPN	
	NPN/PNP	•
	relay	•
Connection	other	
	cable	
	connector	•
	pig-tail	
Approximate dimensions (mm)	25x100x70	
Housing material	PBT	
Mechanical protection	IP67	

TECHNICAL DATA

Power supply	12 ... 30 Vdc (mod. S300...2) 24...240 Vac/24...60 Vdc (mod. S300...1)
Ripple	10% max.
Consumption (output current excluded)	35 mA max. (mod. S300...2) 3 VA max. (mod. S300...1)
Light emission	red LED 660 nm (mod. S300...B) IR LED 940 nm (mod. S300...C) IR LED 880 nm (mod. S300...A/G/M)
Setting	sensitivity trimmer (mod. S300...A/B/C/F), DARK/LIGHT dip-switch (mod. S300...A/B/C/F/M) 7-turns distance adjustment trimmer (mod. S300...M) dip-switch mode ON delay/OFF delay/ON-OFF delay/single pulse (ONE-SHOT) (mod. S300...x06) timing trimmer (mod. S300...x06)
Indicators	yellow OUTPUT LED (excl. mod. S300...G) green STABILITY LED, POWER LED (mod. S300...G)
Output	PNP or NPN open collector (mod. S300...2); electromechanical SPDT 250 Vac/30 Vdc (mod. S300...1)
Output current	100 mA (mod. S300...2) 3 A max. (mod. S300...1)
Saturation voltage	2,4 V max.
Response time	1 ms (mod. S300..2-A/B/C/M) 2 ms (mod. S300..2-F/G) 25 ms (mod. S300...1)
Switching frequency	500 Hz (mod. S300..2-A/B/C/M) 250 Hz (mod. S300..2-F/G) 20 Hz max. (mod. S300...1)
Connection	terminal block
Dielectric strength	500 Vac, 1 min between electronics and housing
Insulating resistance	>20 MΩ, 500 Vdc between electronics and housing
Electrical protection	class 2 (mod. S300...2)
Mechanical protection	IP67 (IEC/EN60529)
Ambient light rejection	according to EN 60947-5-2
Vibrations	0,5 mm amplitude, 10 ... 55 Hz frequency, for every axis (EN60068-2-6)
Shock resistance	11 ms (30 G) 6 shock for every axis (EN60068-2-27)
Housing material	PBT 30% glass fiber-reinforced
Lens material	frontal window and lens in PC
Operating temperature	-25 ... 55 °C
Storage temperature	-25 ... 70 °C
Weight	120 g (mod. S300...2), 130 g (mod. S300...1)

DIMENSIONS

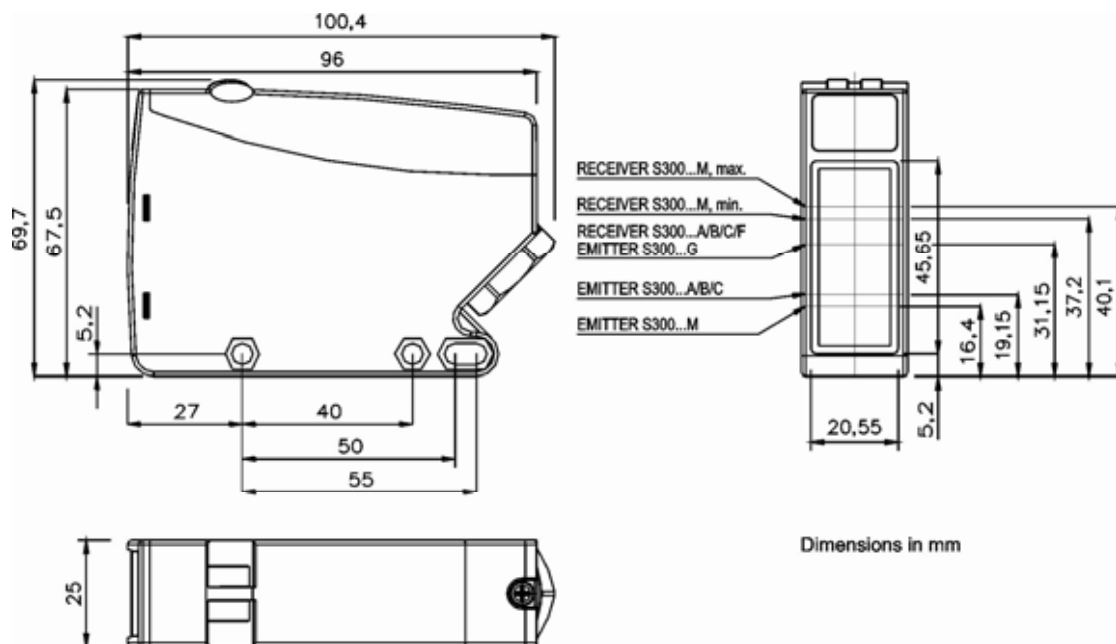

CONNECTIONS

VAC MODELS

Through beam emitter

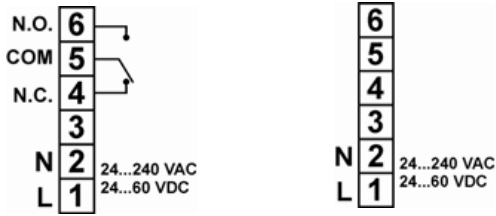

VDC MODELS

Through beam emitter



INDICATORS AND SETTINGS

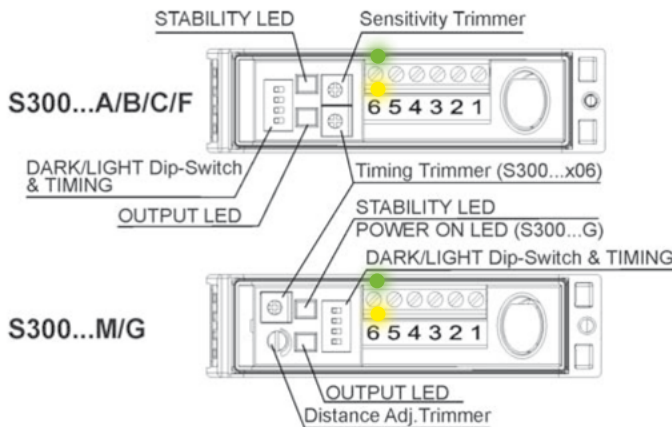

Settings

The M model presents a **multiturn adjustment screw** for the adjustment of the background suppression distance using a mechanical variation of the optic triangulation angle. The **other models have a mono-turn electronic trimmer** that adjusts the sensitivity and the sensor operating distance. The operating distance can be increased by rotating the screws clockwise. Trimmers can be used to adjust the output activation and deactivation delay time whilst functioning mode selection is performed through DIP SWITCHES.

DETECTION DIAGRAMS

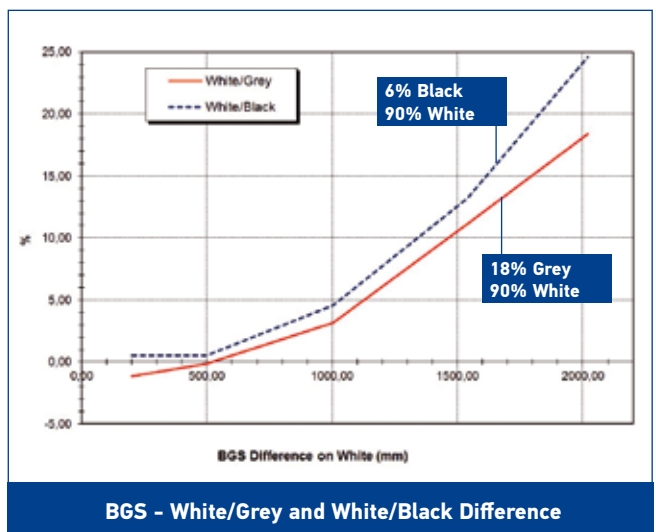
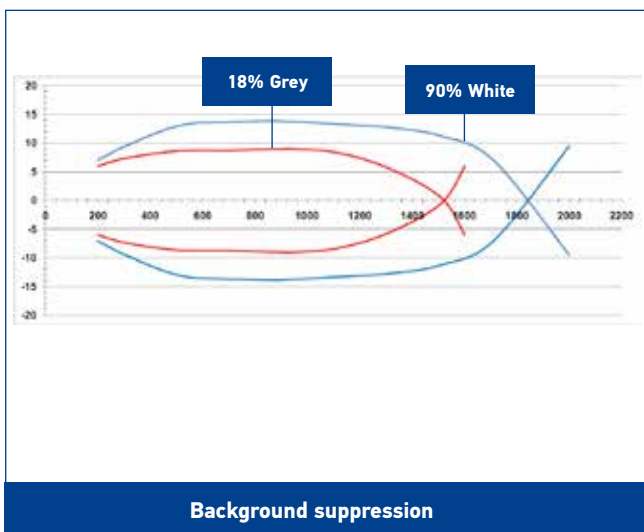
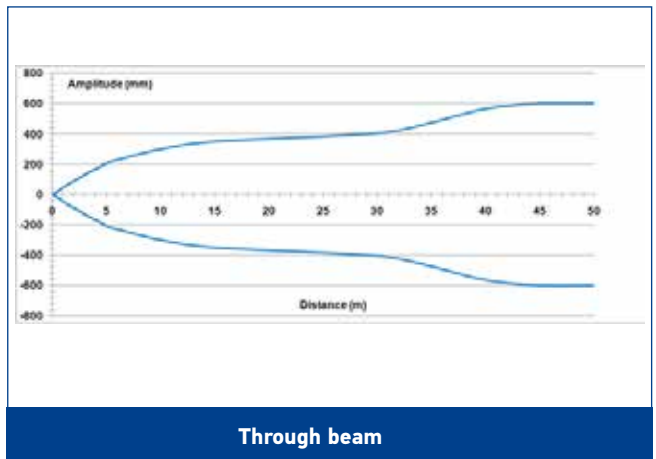
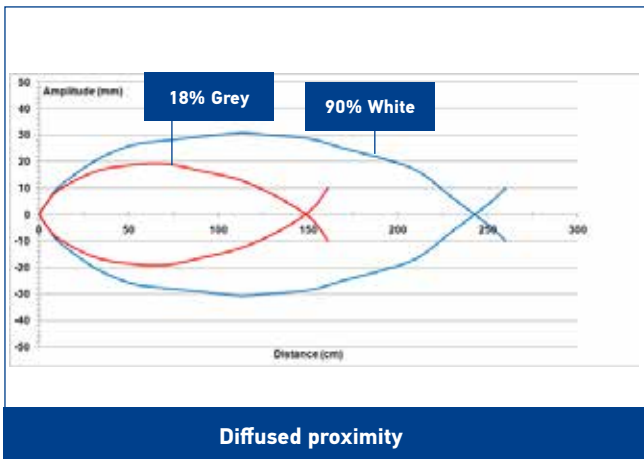
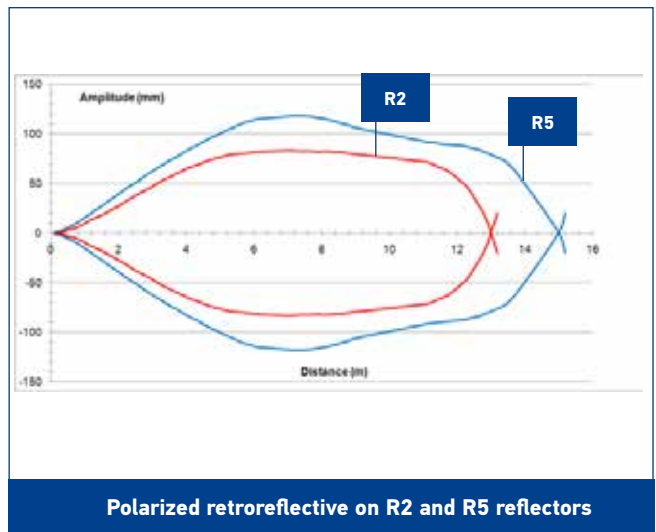
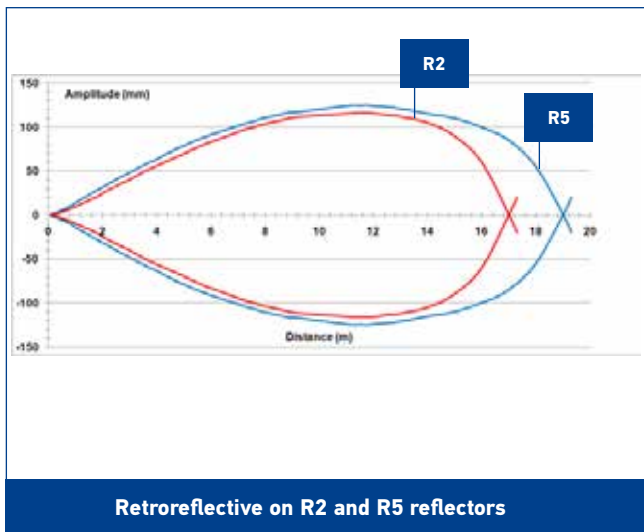

MODEL SELECTION AND ORDER INFORMATION

OPTIC FUNCTION	POWER SUPPLY	OUTPUT	SETTING	MODEL	ORDER No.
Retroreflective (IR LED 880 nm)	12...30 Vdc	NPN/ PNP	Sensitivity trimmer and D/L dip-switch	S300-PA-2-A01-OC	951451500
			Timing and sensitivity trimmers, D/L dip-switch	S300-PA-2-A06-OC	951451510
	24...240 Vac/24...60 Vdc	Relay	Sensitivity trimmer and D/L dip-switch	S300-PA-1-A01-RX	951451480
			Timing and sensitivity trimmers, D/L dip-switch	S300-PA-1-A06-RX	951451490
Polarized retroreflective (red LED 660 nm)	12...30 Vdc	NPN/ PNP	Sensitivity trimmer and D/L dip-switch	S300-PA-2-B01-OC	951451540
			Timing and sensitivity trimmers, D/L dip-switch	S300-PA-2-B06-OC	951451550
	24...240 Vac/24...60 Vdc	Relay	Sensitivity trimmer and D/L dip-switch	S300-PA-1-B01-RX	951451520
			Timing and sensitivity trimmers, D/L dip-switch	S300-PA-1-B06-RX	951451530
Diffused proximity (IR LED 940 nm)	12...30 Vdc	NPN/ PNP	Sensitivity trimmer D/L dip-switch	S300-PA-2-C01-OC	951451420
			Timing and sensitivity trimmers, D/L dip-switch	S300-PA-2-C06-OC	951451430
	24...240 Vac/24...60 Vdc	Relay	Sensitivity trimmer and D/L dip-switch	S300-PA-1-C01-RX	951451400
			Timing and sensitivity trimmers, D/L dip-switch	S300-PA-1-C06-RX	951451410
Through beam receiver	12...30 Vdc	NPN/ PNP	Sensitivity trimmer and D/L dip-switch	S300-PA-2-F01-OC	951451600
			Timing and sensitivity trimmers, D/L dip-switch	S300-PA-2-F06-OC	951451610
	24...240 Vac/24...60 Vdc	Relay	Sensitivity trimmer and D/L dip-switch	S300-PA-1-F01-RX	951451580
			Timing and sensitivity trimmers, D/L dip-switch	S300-PA-1-F06-RX	951451590
Through beam emitter (IR LED 880 nm)	12...30 Vdc	-	-	S300-PA-2-G00-EX	951451570
	24...240 Vac/24...60 Vdc		-	S300-PA-1-G00-EX	951451560
Background suppression (IR LED 880 nm)	12...30 Vdc	NPN/ PNP	7-turns distance adjustment trimmer and /L dip-switch	S300-PA-2-M01-OC	951451460
			Timing and 7-turns distance adj. trimmers, D/L dip-switch	S300-PA-2-M06-OC	951451470
	24...240 Vac/24...60 Vdc	Relay	7-turns distance adjustment trimmer and D/L dip-switch	S300-PA-1-M01-RX	951451440
			Timing and 7-turns distance adj. trimmers, D/L dip-switch	S300-PA-1-M06-RX	951451450

ACCESSORIES

ST-511

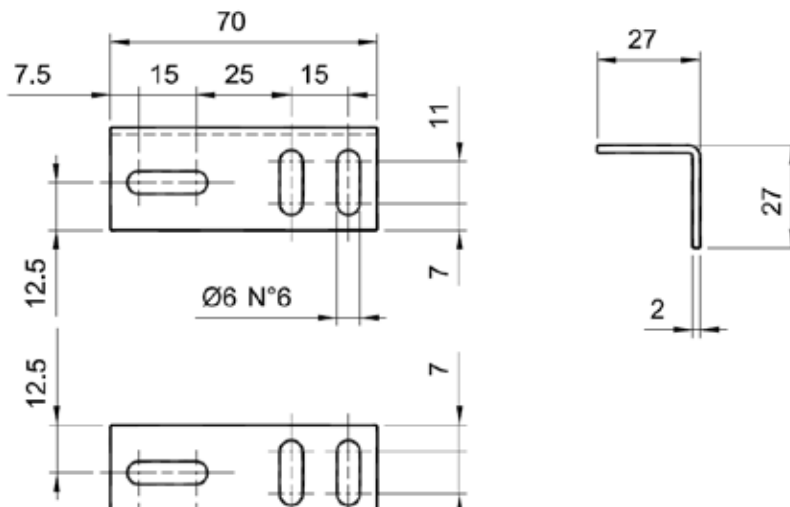

ST-S300-PA

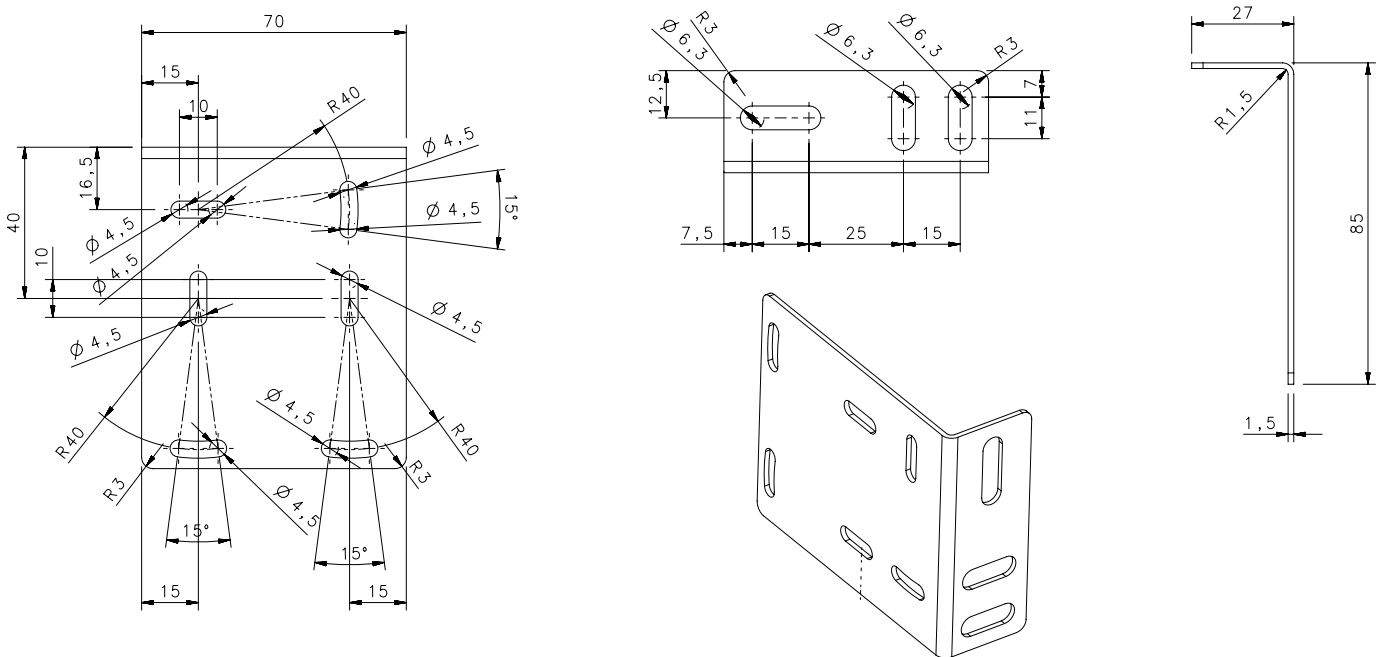

MODEL	DESCRIPTION	ORDER No.
ST-511	mounting bracket	95ACC2810
ST-S300-PA	mounting bracket	95ACC7870

S300 PR



HEAVY DUTY SENSOR FOR OUTDOOR APPLICATIONS AND HARSH ENVIRONMENTS

- Industrial plastic housing with IP67 mechanical protection
- Defogging system function
- Double independent timing functions with double time scale from 0-2s or 0-10s, One-Delay, Off Delay, ONE SHOT



APPLICATIONS

- Packaging end of line, palletizers
- Outdoor or indoor gates control
- Automotive plants
- Automated warehousing

(*)DC models: ATEX II 3DG

S300 PA		
Through beam	0...60 m	
Polarized retroreflective	0,1...22 m	
Diffuse proximity	0,05...5 m	
Background suppression	0,4...2,5 m	
Power supply	Vdc	10...30 V
	Vac	
	Vac/dc	24...240 Vac/24...60 Vdc
Output	PNP	
	NPN	
	NPN/PNP	•
	relay	•
	other	
Connection	cable	
	connector	•
	pig-tail	
Approximate dimensions (mm)	25x100x70	
Housing material	PBT	
Mechanical protection	IP67	

TECHNICAL DATA

Power supply	10 ... 30 Vdc (mod. S300...2/5) 24...240 Vac/24...60 Vdc (mod. S300...1)
Ripple	10% max.
Consumption (output current excluded)	30 mA max. (mod. S300...2/5-B/C) 35 mA max. (mod. S300...2/5-M) 25 mA max. (mod. S300...2/5-F) 20 mA max. (mod. S300...2/5-G) 3 VA max. (mod. S300...1) red LED 660 nm (mod. S300...B) IR LED 880 nm (mod. S300...C/G/M)
Light emission	sensitivity trimmer, DARK/LIGHT trimmer (mod. S300...F/C/B) 15 turns adjustment screw/DARK/LIGHT trimmer (mod. S300...M) emission power regulation trimmer (mod. S300...G)
Setting	versions with timing functions: time base selection and one shot trimmer/ON DELAY trimmer/OFF DELAY trimmer (mod. S300...x06)
Indicators	yellow OUTPUT LED (excl. mod. S300...G) green STABILITY LED, POWER LED (mod. S300...G)
Output	PNP or NPN open collector (mod. S300...2/5); Electromechanical SPDT 250 Vac/30 Vdc (mod. S300...1)
Output current	100 mA (mod. S300...2/5) 3 A max. (mod. S300...1)
Saturation voltage	2,4 V max.
Response time	1 ms (mod. S300...2/5-B/C/F/G) 2 ms (mod. S300...2/5-M) 20 ms (mod. S300...1)
Switching frequency	500 Hz (mod. S300...2/5-/B/C/F/G) 250 Hz (mod. S300...2/5-M) 25 Hz (mod. S300...1)
Connection	terminal block, M12 4-pole connector (only DC mod.)
Dielectric strength	500 Vac, 1 min between electronics and housing
Insulating resistance	>20 MΩ, 500 Vdc between electronics and housing
Electrical protection	class 2 (mod. S300...2/5)
Mechanical protection	IP67 (IEC/EN60529)/cable gland EN50262
Ambient light rejection	according to EN 60947-5-2
Vibrations	0,5 mm amplitude, 10 ... 55 Hz frequency, for every axis (EN60068-2-6)
Shock resistance	11 ms (30 G) 6 shock for every axis (EN60068-2-27)
Housing material	PBT 30% glass fiber-reinforced
Lens material	frontal window and lens in PC
Operating temperature	-40 ... 55 °C
Storage temperature	-40 ... 70 °C
Weight	140 g (mod. S300...2/5), 150 g (mod. S300...1)

DIMENSIONS

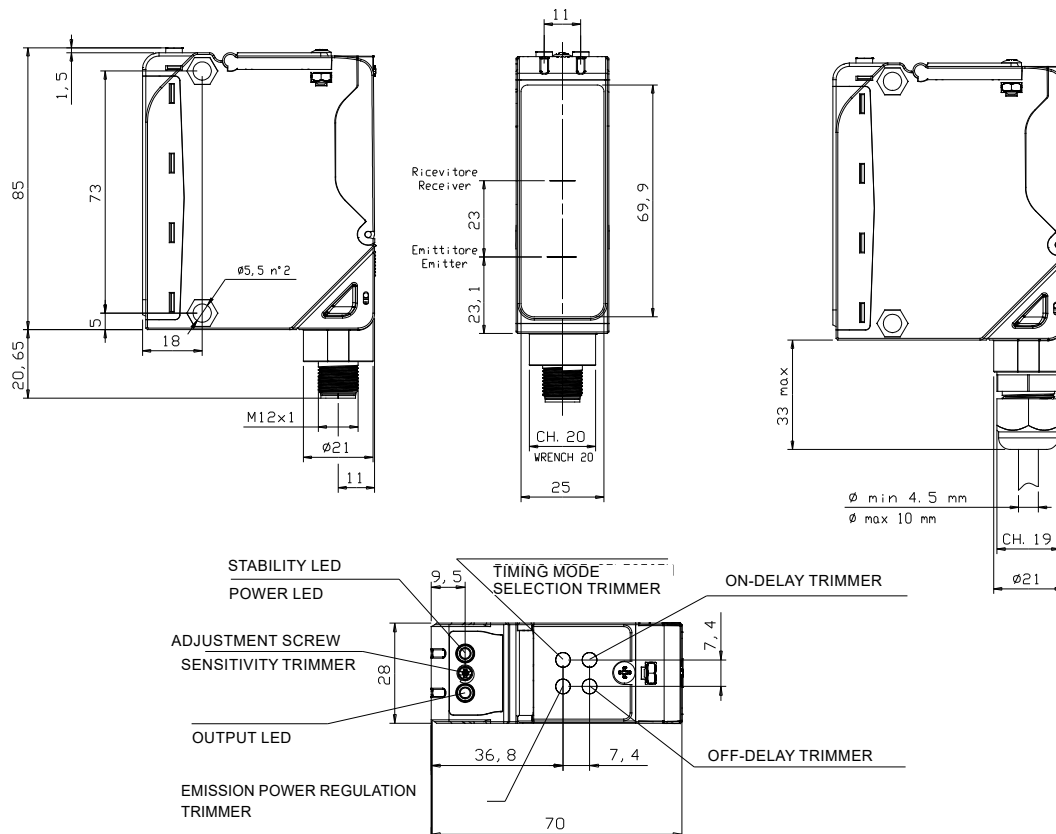

INDICATORS AND SETTINGS

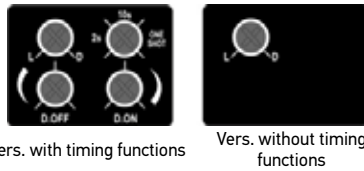
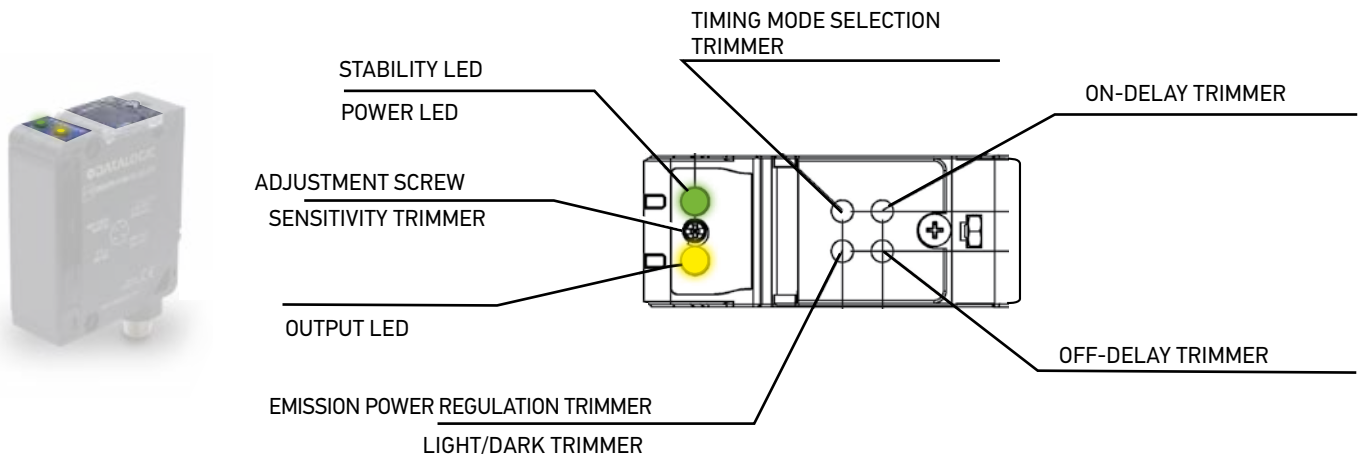

CONNECTIONS

TERMINAL BLOCK

VAC/VDC MODELS

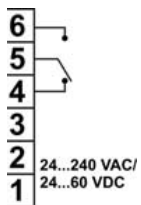

VDC MODELS



M12 CONNECTOR (only DC models)

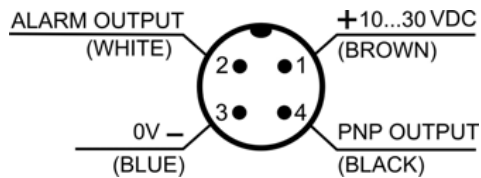

Through beam emitter

TERMINAL BLOCK

AC MODELS

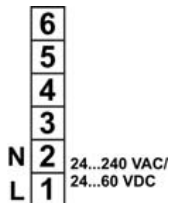

DC MODELS

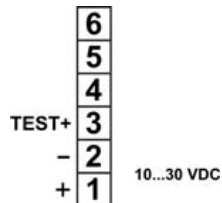

M12 CONNECTOR (only DC models)

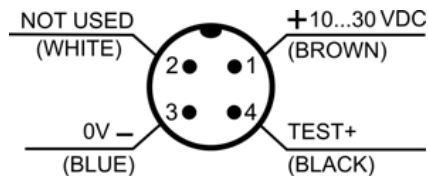

DETECTION DIAGRAMS

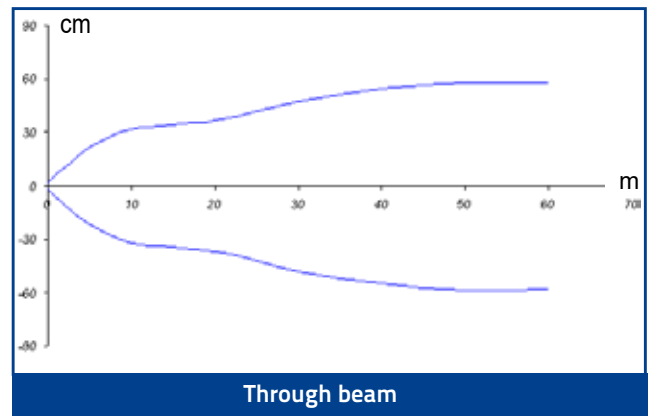
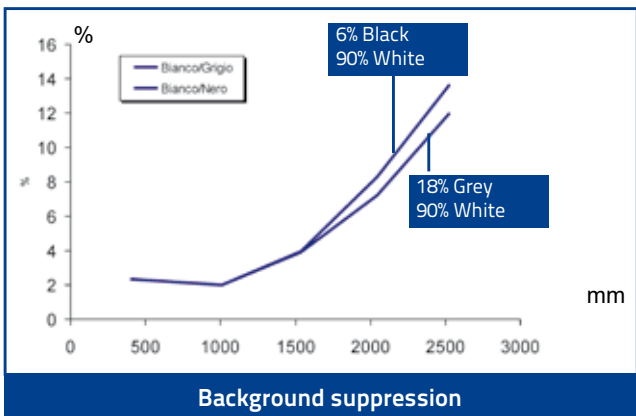
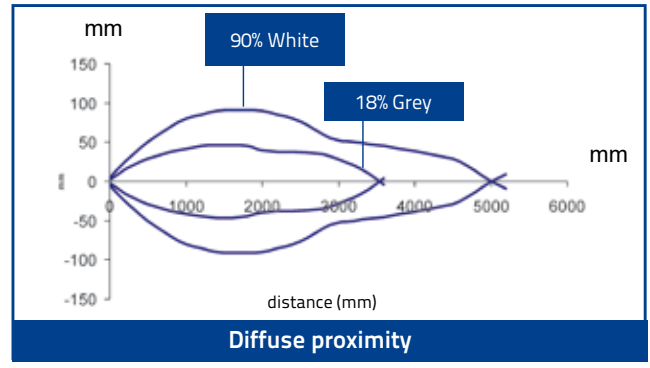
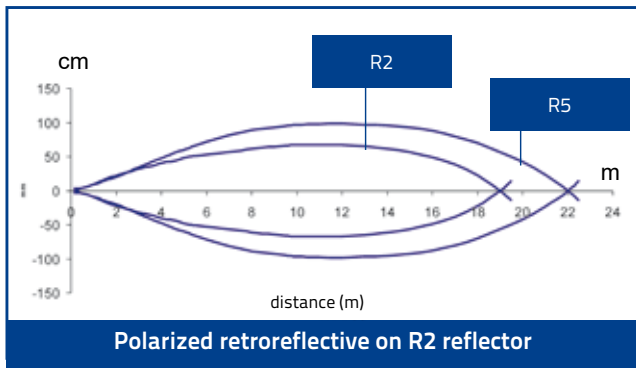

MODEL SELECTION AND ORDER INFORMATION

OPTIC FUNCTION	OUTPUT	CONNECTION	SETTING	MODEL	ORDER NO.	
Polarized retroreflective	NPN/PNP	Vdc - Terminal block	Sensitivity and D/L trimmers	S300-PR-2-B01-OC	951451000	
			Timing, sensitivity and D/L trimmers	S300-PR-2-B06-OC	951451010	
		Vdc - M12 Connector	Sensitivity and D/L trimmers	S300-PR-5-B01-OC	951451020	
			Timing, sensitivity and D/L trimmers	S300-PR-5-B06-OC	951451030	
	Relay	Vac - Terminal block	Sensitivity and D/L trimmers	S300-PR-1-B01-RX	951451040	
			Timing, sensitivity and D/L trimmers	S300-PR-1-B06-RX	951451050	
Diffused proximity	NPN/PNP	Vdc - Terminal block	Sensitivity and D/L trimmers	S300-PR-2-C01-OC	951451070	
			Timing, sensitivity and D/L trimmers	S300-PR-2-C06-OC	951451080	
		Vdc - M12 Connector	Sensitivity and D/L trimmers	S300-PR-5-C01-OC	951451090	
			Timing, sensitivity and D/L trimmers	S300-PR-5-C06-OC	951451100	
		Relay	Vac - Terminal block	Sensitivity and D/L trimmers	S300-PR-1-C01-RX	951451110
				Timing, sensitivity and D/L trimmers	S300-PR-1-C06-RX	951451120
	Through beam receiver	NPN/PNP	Vdc - Terminal block	Timing, sensitivity and D/L trimmers; defogging function	S300-PR-1-C06-RX-M	951451130
				Sensitivity and D/L trimmers	S300-PR-2-F01-OC	951451210
			Vdc - M12 Connector	Timing, sensitivity and D/L trimmers	S300-PR-2-F06-OC	951451220
				Sensitivity and D/L trimmers	S300-PR-5-F01-OC	951451230
Through beam emitter	-	Vac - Terminal block	Timing, sensitivity and D/L trimmers	S300-PR-5-F06-OC	951451240	
			Sensitivity and D/L trimmers	S300-PR-1-F01-RX	951451250	
		Vdc - Terminal block	Timing, sensitivity and D/L trimmers	S300-PR-1-F06-RX	951451260	
			Timing, sensitivity and D/L trimmers; defogging function	S300-PR-1-F06-RX-M	951451270	
Background suppression	NPN/PNP	Vdc - Terminal block	Sensitivity and D/L trimmers	S300-PR-2-G00-EX	951451280	
			Timing, sensitivity and D/L trimmers	S300-PR-5-G00-EX	951451290	
		Vdc - M12 Connector	Sensitivity and D/L trimmers	S300-PR-1-G00-EX	951451300	
	Timing, sensitivity and D/L trimmers; defogging function		S300-PR-1-G00-EX-M	951451310		
	Relay	Vac - Terminal block	Sensitivity and D/L trimmers	S300-PR-2-M01-OC	951451140	
			Timing, sensitivity and D/L trimmers	S300-PR-2-M06-OC	951451150	
Sensitivity and D/L trimmers			S300-PR-5-M01-OC	951451160		
Background suppression	Relay	Vac - Terminal block	Timing, sensitivity and D/L trimmers	S300-PR-5-M06-OC	951451170	
			Sensitivity and D/L trimmers	S300-PR-1-M01-RX	951451180	
			Timing, sensitivity and D/L trimmers	S300-PR-1-M06-RX	951451190	
			Timing, sensitivity and D/L trimmers; defogging function	S300-PR-1-M06-RX-M	951451200	

ACCESSORIES

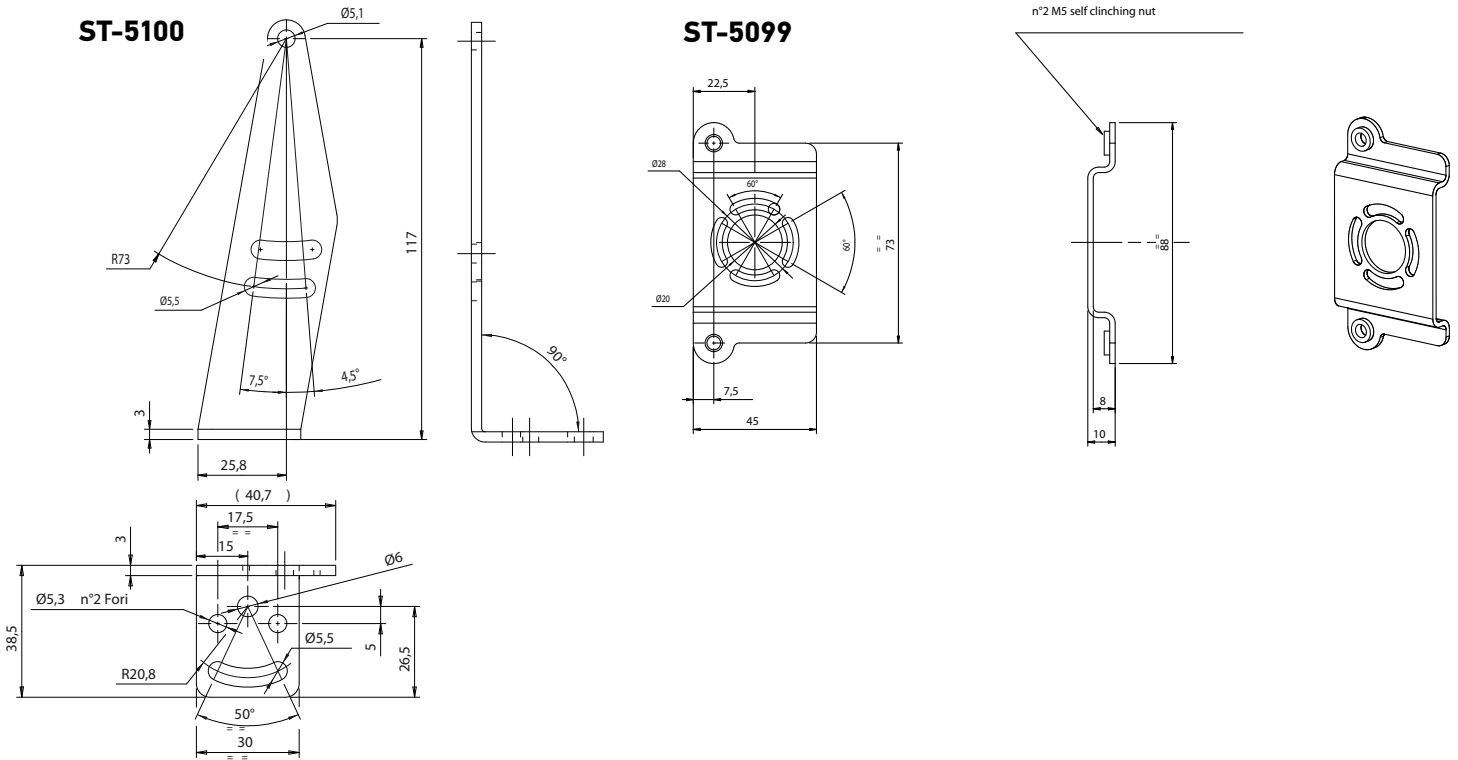

MODEL	DESCRIPTION	ORDER No.
ST-5099	mounting BRACKET	95ACC2830
ST-5100	mounting BRACKET	95ACC2840

CABLES

TYPE	DESCRIPTION	LENGTH	MODEL	ORDER No.
Axial M12 Connector	4-pole, grey, P.V.C.	3 m	CS-A1-02-G-03	95A251380
		5 m	CS-A1-02-G-05	95A251270
		7 m	CS-A1-02-G-07	95A251280
		10 m	CS-A1-02-G-10	95A251390
	4-pole, P.U.R.	2 m	CS-A1-02-R-02	95A251540
		5 m	CS-A1-02-R-05	95A251560
Radial M12 Connector	4-pole, grey, P.V.C.	3 m	CS-A2-02-G-03	95A251360
		5 m	CS-A2-02-G-05	95A251240
		7 m	CS-A2-02-G-07	95A251245
		10 m	CS-A2-02-G-10	95A251260
	4-pole, P.U.R.	2 m	CS-A2-02-R-02	95A251550
		5 m	CS-A2-02-R-05	95A251570
Axial M12 Connector	4-pole, shielded, black, P.V.C.	3 m	CV-A1-22-B-03	95ACC1480
		5 m	CV-A1-22-B-05	95ACC1490
		10 m	CV-A1-22-B-10	95ACC1500
		15 m	CV-A1-22-B-15	95ACC2070
		25 m	CV-A1-22-B-25	95ACC2090
Radial M12 Connector	4-pole, shielded, black, P.V.C.	3 m	CV-A2-22-B-03	95ACC1540
		5 m	CV-A2-22-B-05	95ACC1550
		10 m	CV-A2-22-B-10	95ACC1560
Axial M12 Connector	4-pole, U.L., black, P.V.C.	3 m	CS-A1-02-U-03	95ASE1120
		5 m	CS-A1-02-U-05	95ASE1130
		10 m	CS-A1-02-U-10	95ASE1140
		15 m	CS-A1-02-U-15	95ASE1150
		25 m	CS-A1-02-U-25	95ASE1160
Radial M12 Connector	4-pole, black	Connector- not cabled	CS-A1-02-B-NC	G5085002
Radial M12 Connector	4-pole, black	Connector- not cabled	CS-A2-02-B-NC	G5085003



DATALOGIC

S300-PR-5-F00-OC-SG-ST4



001314
Made in Italy

CE

www.datalogic.com

AS1



AREASCAN™ HIGH-RESOLUTION DETECTION PHOTOELECTRIC LIGHT GRIDS

- Crossed beam area sensors
- 100mm controlled height
- Adjustment trimmer
- Optical or wire synchronism
- Scan Mode input

APPLICATIONS

- Processing lines
- Food, Cosmetic and Pharmaceutical
- Electronics and mechanical assembling
- Conveyor lines and sorting systems



AS1	
Area sensing	100 mm
Operating Distance	0,3...2,1 m (AS1-LD)
	0,8...3 m (AS1-HD)
Resolution	Flat: 0,2x75mm Cylindrical: Ø 6mm (AS1-HR)
	Flat: 0,2x200mm Cylindrical: Ø18mm (AS1-SR)
Response Time	1,75 ms (AS1-SR)
	2,75...8 ms (AS1-HR)
Light emission	IR LED
Power supply	Vdc
	Vac
	Vac/dc
Output	PNP
	NPN
	NPN/PNP
	relay
	other
Connection	cable
	connector
	pig-tail
Approximate dimensions (mm)	22x43x150
Housing material	aluminium
Mechanical protection	IP65

TECHNICAL DATA

Power supply	24 Vdc \pm 15%
Consumption on emitter unit (TX)	150 mA max.
Consumption on receiver unit (RX)	40 mA max. load excluded
Light emission	IR LED 880 nm
Setting	adjustment trimmer (mod. AS1...P)
Indicators	yellow OUTPUT LED green POWER ON LED
Output	PNP
Output current	100 mA max.
Saturation voltage	1,5 V max.
Response time	2,75 - 8 ms (mod. AS1-HR) 1,75 ms (mod. AS1-SR)
Connection	M12 4-pole connector (TX), M12 5-pole connector (RX)
Dielectric strength	500 Vac, 1 min between electronics and housing
Insulating resistance	>20 M Ω , 500 Vdc between electronics and housing
Mechanical protection	IP65 (EN 60529)
Vibrations	0,5 mm amplitude, 10 ... 55 Hz frequency, for every axis (EN60068-2-6)
Shock resistance	11 ms (30 G) 6 shock for every axis (EN60068-2-27)
Housing material	black electro-painted aluminium
Lens material	PMMA
Operating temperature	0 ... 50 °C
Storage temperature	-25 ... 70 °C
Weight	300 g

DIMENSIONS

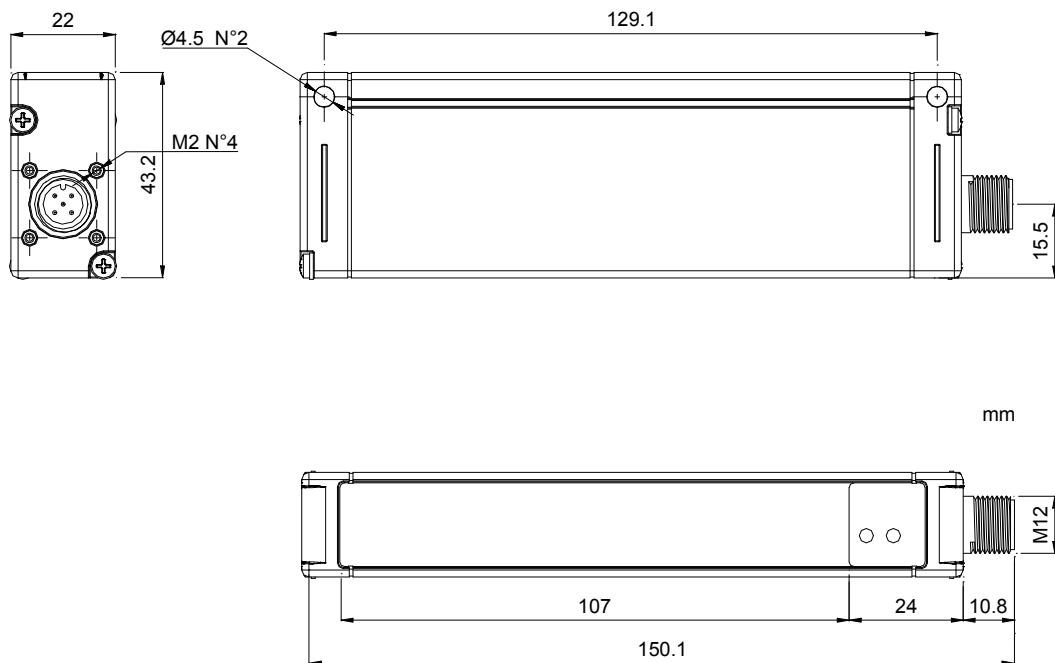

INDICATORS AND SETTINGS

Two different models are available: high resolution (AS1-HR) or standard resolution (AS1-SR). In the first case the light array has 16 beams, while in the second case the beams are reduced to 6. In the AS1-HR model, the selection inputs of the SCAN MODE, can configure 4 different crossed-beam scanning modes. These different modes allow to vary the detection performances, in particular the resolution can be increased to 0.2mm thickness, or the response time up to less than 3ms.

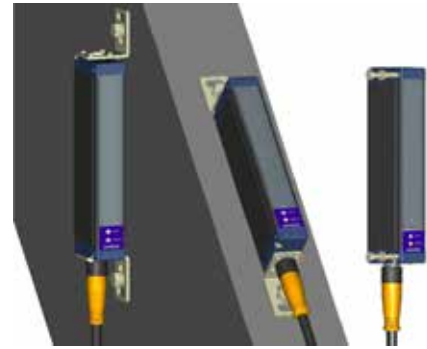

INDICATORS AND SETTINGS (TRIMMER VERSION)

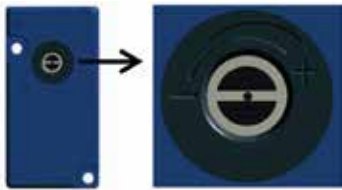

Emitter is equipped with a manual regulation which lets the user change the emission power by means of a screwdriver. The emission power reduction can be particularly useful to lower passive reflections when maximum operating distance it is not required.

CONNECTIONS

M12 CONNECTOR

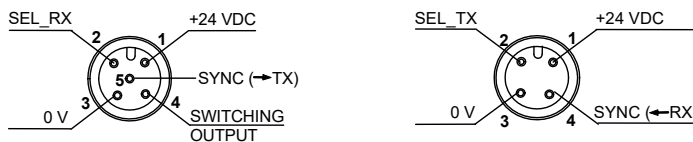

		AS1-HR	AS1-SR			AS1-HR	AS1-SR
RECEIVER (RX): M12 5-pole connector	1 – brown:	+24 VDC	+24 VDC	EMITTER (TX): M12 4-pole connector	1 – brown:	+24 VDC	+24 VDC
	2 – white:	SEL_RX	Not used		2 – white:	SEL_TX	Not used
	3 – blue:	0 V	0 V		3 – blue:	0 V	0 V
	4 – black:	Switching output	Switching output		4 – black:	SYNC **	SYNC *
	5 – grey:	SYNC*	SYNC*				

* not used in trimmer version
** SEL_TX2 in trimmer version

HIGH RESOLUTION SCANNING MODE

PROG. N°	SEL_RX	SEL_TX	RESOLUTION	RESPONSE TIME (msec)
1	0 Vdc or FLOAT	0 Vdc or FLOAT	LOW	2.75
2	0 Vdc or FLOAT	24 Vdc	M/L	3
3	24 Vdc	0Vdc or FLOAT	M/H	7.75
4	24 Vdc	24 Vdc	HIGH	8

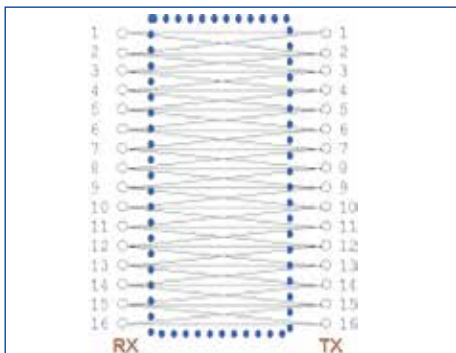

Scan mode 1:
high speed / low resolution
Minimum object detection
Flat = 0.4 (thickness) x 100 (width) mm
Cylindrical objects = Ø 6 mm

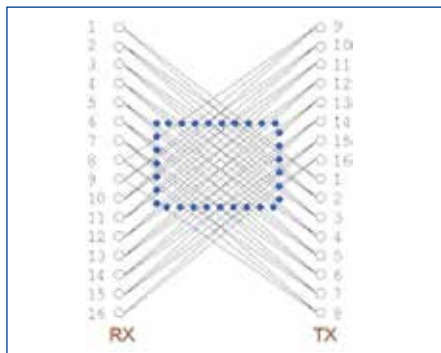

Scan mode 2:
high speed / mid resol. central area
Minimum object detection
Flat = 0.4 (thickness) x 90 (width) mm
Cylindrical objects = Ø 6 mm

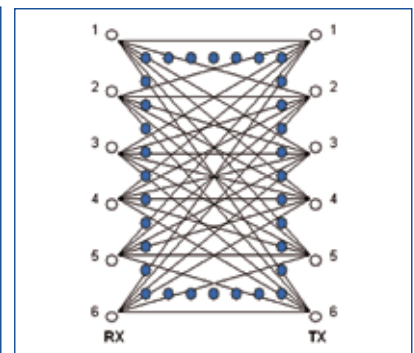

Scan mode 3-4:
low speed / high resolution
Minimum object detection
Flat = 0.2 (thickness) x 75 (width) mm
Cylindrical objects = Ø 6 mm

STANDARD RESOLUTION SCANNING MODE

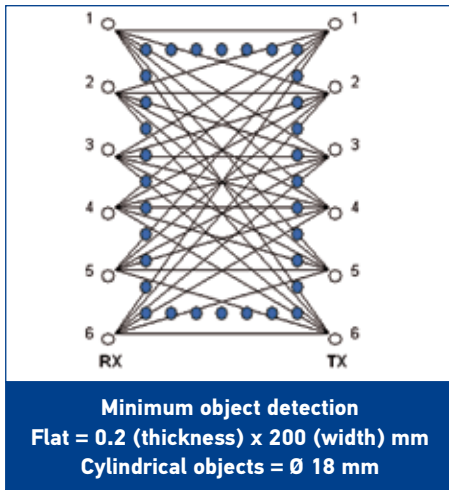

Note: the scan mode is fixed in the standard resolution version.

MODEL SELECTION AND ORDER INFORMATION

OPTIC FUNCTION	OPERATING DISTANCE	RESOLUTION	SETTING	MODEL	ORDER No.
Area sensor	2 m	High	n/a	AS1-LD-HR-010-J	958101000
			Adjustment Trimmer	AS1-LD-HR-010-P	958101040
		Standard	n/a	AS1-LD-SR-010-J	958101010
			Adjustment Trimmer	AS1-LD-SR-010-P	958101050
	3 m	High	n/a	AS1-HD-HR-010-J	958101020
		Standard	n/a	AS1-HD-SR-010-J	958101030

CABLES

TYPE	DESCRIPTION	LENGTH	MODEL	ORDER No.	
Axial M12 Connector	4-pole, grey, P.V.C.	3 m	CS-A1-02-G-03	95A251380	
		5 m	CS-A1-02-G-05	95A251270	
		10 m	CS-A1-02-G-10	95A251390	
	4-pole, U.L., black, P.V.C.	3 m	CS-A1-02-U-03	95ASE1120	
		5 m	CS-A1-02-U-05	95ASE1130	
		10 m	CS-A1-02-U-10	95ASE1140	
		15 m	CS-A1-02-U-15	95ASE1150	
		25 m	CS-A1-02-U-25	95ASE1160	
	5-pole, grey, P.V.C.	3 m	CS-A1-03-G-03	95ACC2110	
		5 m	CS-A1-03-G-05	95ACC2120	
		10 m	CS-A1-03-G-10	95ACC2140	
	5-pole, U.L., black, P.V.C.	3 m	CS-A1-03-U-03	95ASE1170	
		5 m	CS-A1-03-U-05	95ASE1180	
		10 m	CS-A1-03-U-10	95ASE1190	
		15 m	CS-A1-03-U-15	95ASE1200	
		25 m	CS-A1-03-U-25	95ASE1210	
			50 m	CS-A1-03-U-50	95A252700

DS1



AREASCAN™ DETECTION AND MEASUREMENT LIGHT GRIDS WITH ANALOG OUTPUT

- 4 mm resolution and 1 ms response time
- 100 to 300 mm controlled height
- Operating distance up to 4 m
- PNP digital and 0-10 V analog outputs
- Adjustment trimmer

APPLICATIONS

- Processing and Packaging machinery
- Food, Cosmetic, Pharmaceutical
- Electronics and mechanical assembling
- Conveyor lines and sorting systems



DS1		
Light array (controlled height)	100...300 mm	
Resolution	4...7 mm	
Number of beams	16...48	
Light emission	IR LED	
Response time	1...2,75 ms (depending on the number of beams)	
Setting	Trimmer	
Operating distance	0,15...0,8 m (SD)	
	0,15...2,1 m (LD)	
	0,2...4 m (HD)	
Power supply	Vdc	
	Vac	
	Vac/dc	
	PNP	•
	NPN	
	NPN/PNP	
Output	relay	
	other	0... 10 V Analog output
	cable	
	connector	•
Connection	pig-tail	
Approximate dimensions (mm)	22x43x(150/350)	
Housing material	aluminium	
Mechanical protection	IP65	

TECHNICAL DATA

Power supply	24 Vdc ± 15%
Consumption on emitter unit (TX)	150 mA max.
Consumption on receiver unit (RX)	50 mA max. load excluded
Light emission	IR LED 880 nm
Setting	adjustment trimmer (mod. DS1...PV)
Indicators	yellow OUTPUT LED green POWER ON LED
Output	PNP; analog output
Output current	100 mA max.
Saturation voltage	1,5 V max.
Response time	1 - 2,75 ms
Connection	M12 4-pole connector (TX), M12 5-pole connector (RX)
Dielectric strength	500 Vac, 1 min between electronics and housing
Insulating resistance	>20 MΩ, 500 Vdc between electronics and housing
Mechanical protection	IP65 (EN 60529)
Vibrations	0,5 mm amplitude, 10 ... 55 Hz frequency, for every axis (EN60068-2-6)
Shock resistance	11 ms (30 G) 6 shock for every axis (EN60068-2-27)
Housing material	black electro-painted aluminium
Lens material	PMMA
Operating temperature	0 ... 50 °C
Storage temperature	-25 ... 70 °C
Weight	300 g (mod. DS1...010) 400 g (mod. DS1...015) 600 g (mod. DS1...030)

DIMENSIONS

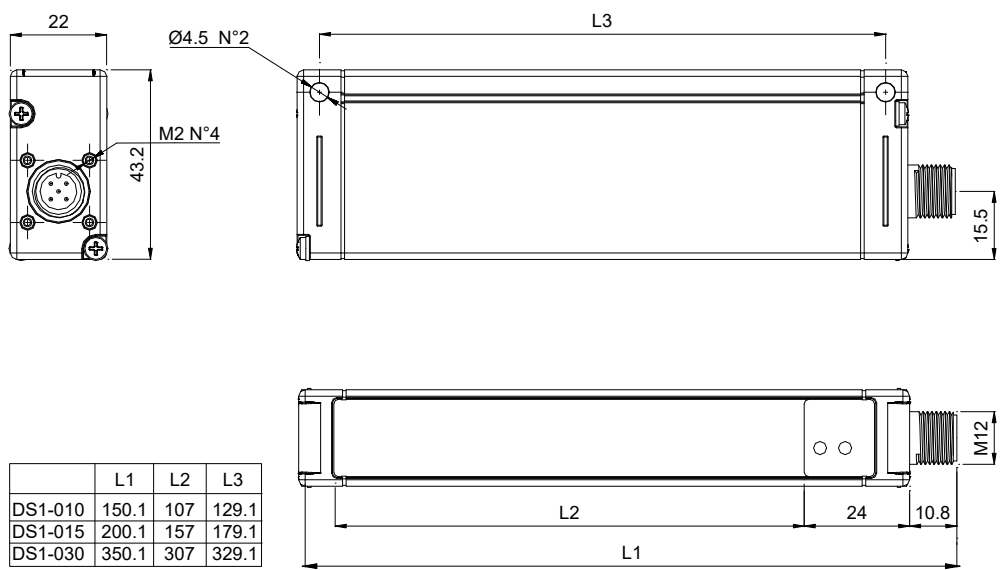

INDICATORS AND SETTINGS (TRIMMER VERSION)



CONNECTIONS

M12 CONNECTOR

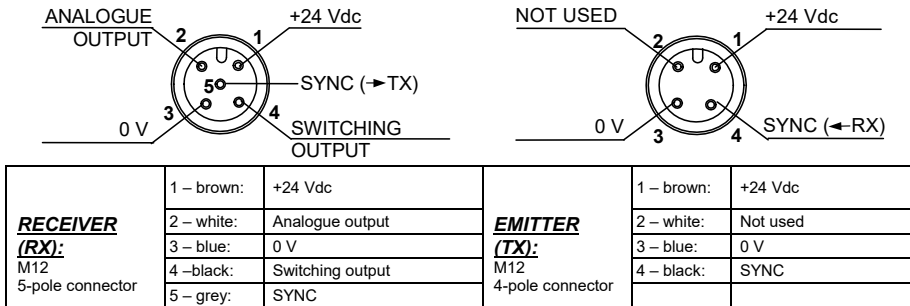

DETECTION DIAGRAMS

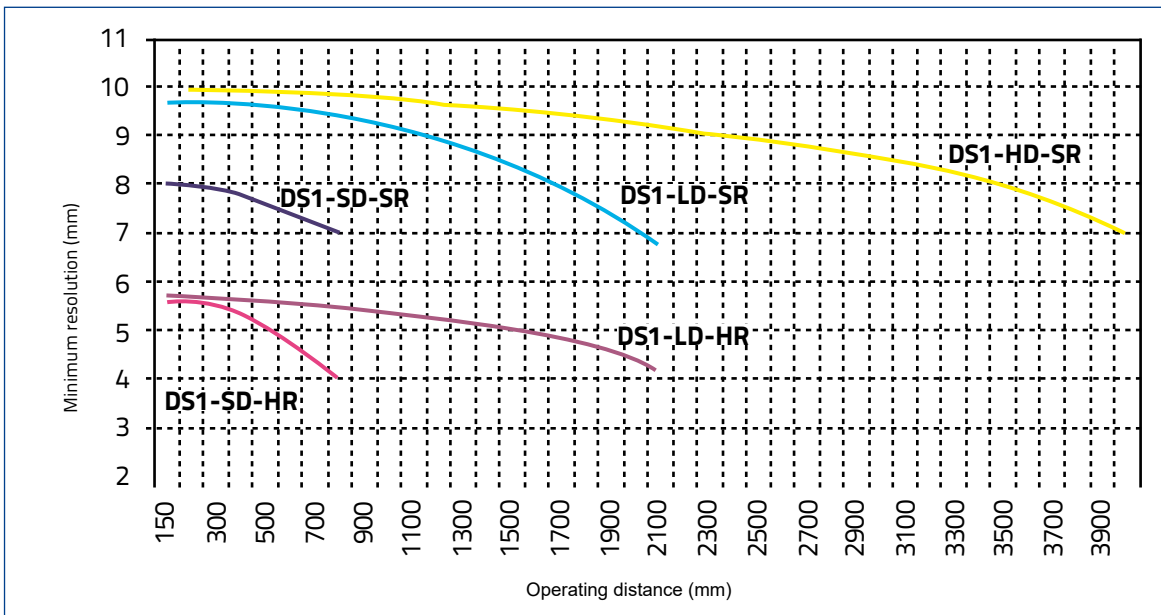

Variation of the minimum resolution according to the operating distance between the emitting and receiving units.

MODEL SELECTION AND ORDER INFORMATION

OPTIC FUNCTION	OPERATING DISTANCE	SETTING	CONTROLLED HEIGHT & RESOLUTION	MODEL	ORDER NO	
Measurement light curtain	0,8 m	n/a	100 mm (res.: 7 mm)	DS1-SD-SR-010-JV	957701170	
			100 mm (res.: 4 mm)	DS1-SD-HR-010-JV	957701200	
			150 mm (res.: 7 mm)	DS1-SD-SR-015-JV	957701180	
			150 mm (res.: 4 mm)	DS1-SD-HR-015-JV	957701210	
			300 mm (res.: 7 mm)	DS1-SD-SR-030-JV	957701190	
	2 m	n/a	100 mm (res.: 7 mm)	DS1-LD-SR-010-JV	957701130	
			100 mm (res.: 4 mm)	DS1-LD-HR-010-JV	957701120	
			150 mm (res.: 7 mm)	DS1-LD-SR-015-JV	957701150	
			150 mm (res.: 4 mm)	DS1-LD-HR-015-JV	957701140	
			300 mm (res.: 7 mm)	DS1-LD-SR-030-JV	957701160	
			Adjustment trimmer	100 mm (res.: 7 mm)	DS1-LD-SR-010-PV	957701250
				150 mm (res.: 7 mm)	DS1-LD-SR-015-PV	957701260
	300 mm (res.: 7 mm)	DS1-LD-SR-030-PV		957701270		
	4 m	n/a	100 mm (res.: 7 mm)	DS1-HD-SR-010-JV	957701220	
			150 mm (res.: 7 mm)	DS1-HD-SR-015-JV	957701230	
300 mm (res.: 7 mm)			DS1-HD-SR-030-JV	957701240		

CABLES

TYPE	DESCRIPTION	LENGTH	MODEL	ORDER No.
Axial M12 Connector	4-pole, grey, P.V.C.	3 m	CS-A1-02-G-03	95A251380
		5 m	CS-A1-02-G-05	95A251270
		10 m	CS-A1-02-G-10	95A251390
	4-pole, U.L., black, P.V.C.	3 m	CS-A1-02-U-03	95ASE1120
		5 m	CS-A1-02-U-05	95ASE1130
		10 m	CS-A1-02-U-10	95ASE1140
		15 m	CS-A1-02-U-15	95ASE1150
		25 m	CS-A1-02-U-25	95ASE1160
	5-pole, grey, P.V.C.	3 m	CS-A1-03-G-03	95ACC2110
		5 m	CS-A1-03-G-05	95ACC2120
		10 m	CS-A1-03-G-10	95ACC2140
	5-pole, U.L., black, P.V.C	3 m	CS-A1-03-U-03	95ASE1170
		5 m	CS-A1-03-U-05	95ASE1180
		10 m	CS-A1-03-U-10	95ASE1190
		15 m	CS-A1-03-U-15	95ASE1200
		25 m	CS-A1-03-U-25	95ASE1210
		50 m	CS-A1-03-U-50	95A252700

DS2

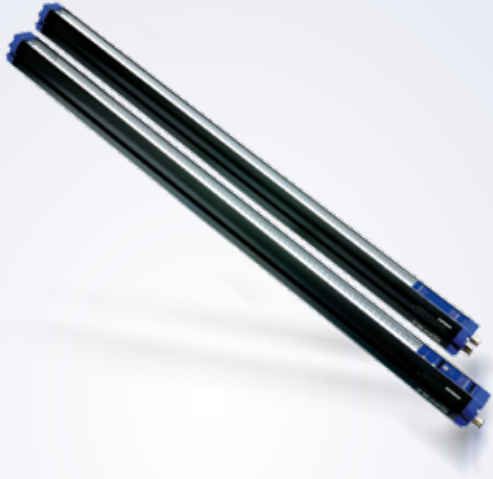

AREASCAN™ DETECTION AND MEASUREMENT LIGHT GRIDS WITH SERIAL OR ETHERNET INTERFACE

- 6 or 25 mm resolution
- Relative measurement precision ± 6 mm or ± 22.5 mm
- 150 - 1650 mm controlled heights
- Operating distance up to 10 m
- PNP and 0-10 V Analog output and RS485 or Ethernet interface

APPLICATIONS

- Processing and Packaging machinery
- Food, Cosmetic, Pharmaceutical
- Electronics and mechanical assembling
- Conveyor lines and sorting systems



DS2		
Light array (controlled height)	150...1650 mm	
Resolution	6 or 25 mm	
Number of beams	21...231 (res= 6mm)	
	6...66 (res= 25mm)	
Light emission	IR LED	
Response time	5...90 ms	
Interface	serial RS485 or Ethernet	
Setting	Dip-switches	
	Graphic interface	
Operating distance	0,3...5 m (res= 6mm)	
	0,3...10 m (res=25mm)	
Power supply	Vdc	24V +/- 20%
	Vac	
	Vac/dc	
Output	PNP	•
	NPN	
	NPN/PNP	
	relay	
	other	0...10 V Analog output
Connection	cable	
	connector	•
	pig-tail	
Approximate dimensions (mm)	35x40x(256...1726)	
Housing material	aluminium	
Mechanical protection	IP65	

TECHNICAL DATA

Power supply	24 Vdc ± 20%
Consumption on emitter unit (TX)	250 mA max. load excluded
Light emission	IR LED 880 nm
Output	PNP; analog output
Output current	100 mA
Saturation voltage	1,5 V max.
Connection	M12 4-pole connector (TX), M12 8-pole and M12 4-pole type "D" connector (RX)
Dielectric strength	500 Vac, 1 min between electronics and housing
Insulating resistance	>20 MΩ, 500 Vdc between electronics and housing
Electrical protection	class I
Mechanical protection	IP65 (EN 60529)
Vibrations	0,5 mm amplitude, 10 ... 55 Hz frequency, for every axis (EN60068-2-6)
Shock resistance	11 ms (30 G) 6 shock for every axis (EN60068-2-27)
Housing material	painted aluminium (Pulverit 5121/0085 Black)
Lens material	PMMA
Operating temperature	0 ... 50 °C
Storage temperature	-25...70°C
Weight	1,9 - 4,6 kg

DIMENSIONS

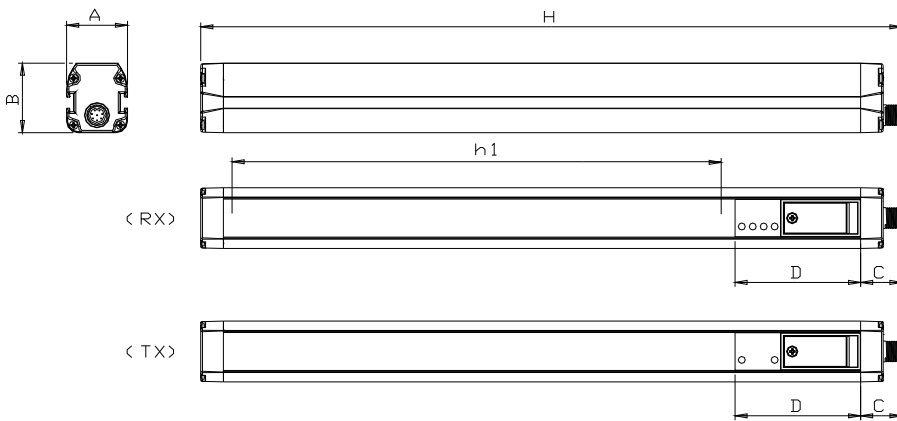

MODEL	A x B (mm)	H (mm)	C (mm)	D (mm)
DS2-05-07-015-XX	35 x 40	256	23.8	72.5
DS2-05-07-030-XX	35 x 40	403	23.8	72.5
DS2-05-07-045-XX	35 x 40	550	23.8	72.5
DS2-05-07-060-XX	35 x 40	697	23.8	72.5
DS2-05-07-075-XX	35 x 40	844	23.8	72.5
DS2-05-07-090-XX	35 x 40	991	23.8	72.5
DS2-05-07-105-XX	35 x 40	1138	23.8	72.5
DS2-05-07-120-XX	35 x 40	1285	23.8	72.5
DS2-05-07-135-XX	35 x 40	1432	23.8	72.5
DS2-05-07-150-XX	35 x 40	1579	23.8	72.5
DS2-05-07-165-XX	35 x 40	1726	23.8	72.5
DS2-05-25-045-XX	35 x 40	562	23.8	72.5
DS2-05-25-060-XX	35 x 40	713	23.8	72.5
DS2-05-25-075-XX	35 x 40	864	23.8	72.5
DS2-05-25-090-XX	35 x 40	1015	23.8	72.5

XX: JV for serial models or JE for ETHERNET models

CONNECTIONS

M12 CONNECTOR - SERIAL VERSION

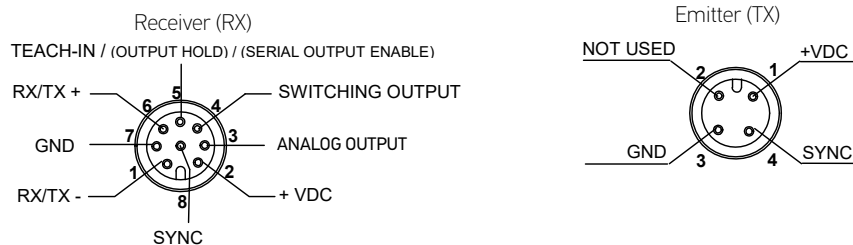

M12 CONNECTOR - ETHERNET VERSION

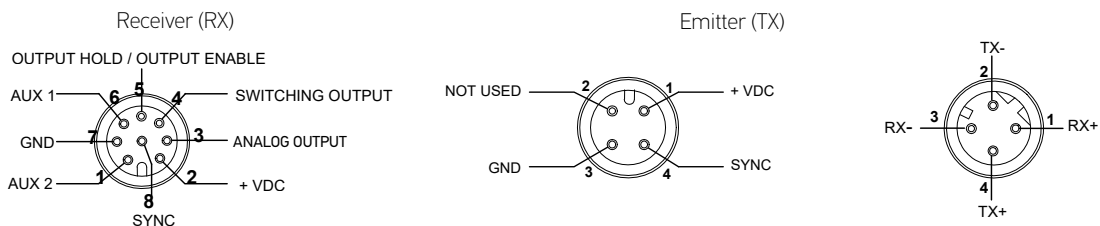

INDICATORS AND SETTINGS



DETECTION MODE EXAMPLES

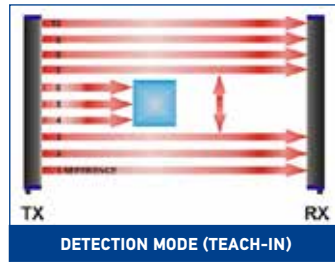
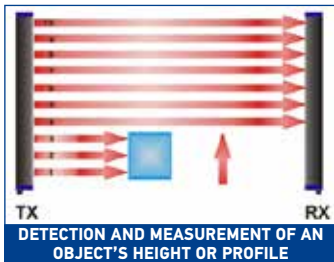

And more applications:

- Object height measurement (vertical mounting);
- Object width measurement (horizontal mounting);
- Object distance measurement (horizontal mounting);
- Object volume measurement (vertical and horizontal combination);
- Single or multiple object presence and/or position detection in a given area;
- Missing label detection on multiple lanes;
- Vertical warehouse drawers positioning;
- Box or other objects profiling on conveyors;
- Web edges or center guiding;
- Cartoners, stackers and palletizers.

RESPONSE TIME - SERIAL AND ETHERNET VERSION

MODEL RS485	Tmin (msec)							Tmax (msec)
	CONFIGURATION							
	Top beam				Complete beams status			
	Binary	Binary	ASCII	ASCII	Binary	Binary	ASCII	ASCII
	57600 baud	9600 baud	57600 baud	9600 baud	57600 baud	9600 baud	57600 baud	9600 baud
DS2-05-07-015-JV	5.5	12.5	5.05	13	5.5	15	6.5	10
DS2-05-07-030-JV	7	14	7	14.5	7	18	8.5	21
DS2-05-07-045-JV	8.5	15.5	8.5	16	8.5	21	10	24
DS2-05-07-060-JV	10	17	10	18	10	26	12	38
DS2-05-07-075-JV	11.5	18.5	11.5	19	11.5	31	15	44
DS2-05-07-090-JV	13	20	13	20	13	36	17	54
DS2-05-07-105-JV	14.5	21.5	14.5	22	14.5	40	19	62
DS2-05-07-120-JV	17	24	17	24	17	44	21	70
DS2-05-07-135-JV	18.5	25	19	26	19	48	23	80
DS2-05-07-150-JV	20	26.5	21	28	21	53	25	84
DS2-05-07-165-JV	22	28	23	30	23	56	28	91
DS2-05-25-045-JV	5	11	5	11	5	13	6	18
DS2-05-25-060-JV	5.5	12	5.5	12.5	5.5	14.5	6.5	19.5
DS2-05-25-075-JV	6	13	6	13.5	6	16	7	21
DS2-05-25-090-JV	6.5	13.5	6.5	14.5	6.5	17.5	7.5	22.5

MODEL ETHERNET	Tmin (msec)				Tmax (msec)
	CONFIGURATION				
	Top beam		Complete beams status		
	Binary	ASCII	Binary	ASCII	
DS2-05-07-060-JE	10	10	10	12	
DS2-05-07-075-JE	11.5	11.5	11.5	15	
DS2-05-07-090-JE	13	13	13	17	
DS2-05-07-120-JE	17	17	17	21	
DS2-05-07-150-JE	20	21	21	25	
DS2-05-07-165-JE	22	23	23	28	

MODEL SELECTION AND ORDER INFORMATION

OPTIC FUNCTION	CONTROLLED AREA (mm)	OPTICS INTERAXIS (mm)	OUTPUT	MODEL	ORDER No.		
Measurement light curtain	147	6.75	PNP, 0-10V and RS485	DS2-05-07-015-JV	957501040		
	294			DS2-05-07-030-JV	957501050		
	441			DS2-05-07-045-JV	957501060		
	588			DS2-05-07-060-JV	957501000		
	735			DS2-05-07-075-JV	957501070		
	882			DS2-05-07-090-JV	957501010		
	1029			DS2-05-07-105-JV	957501080		
	1176			DS2-05-07-120-JV	957501020		
	1323			DS2-05-07-135-JV	957501090		
	1470			DS2-05-07-150-JV	957501100		
	1617			DS2-05-07-165-JV	957501030		
	453			25	PNP, 0-10V and RS485	DS2-05-25-045-JV	957501110
	604					DS2-05-25-060-JV	957501140
	755					DS2-05-25-075-JV	957501120
	912					DS2-05-25-090-JV	957501130
	588	6.75	Voltage Analog and Ethernet	DS2-05-07-060-JE	957501150		
	735			DS2-05-07-075-JE	957501160		
	882			DS2-05-07-090-JE	957501170		
	1176			DS2-05-07-120-JE	957501180		
	1470			DS2-05-07-150-JE	957501190		
	1617			DS2-05-07-165-JE	957501200		

CABLES

TYPE	DESCRIPTION	LENGTH	MODEL	ORDER No.	
Axial M12 Connector	4-pole, grey, P.V.C.	3 m	CS-A1-02-G-03	95A251380	
		5 m	CS-A1-02-G-05	95A251270	
		10 m	CS-A1-02-G-10	95A251390	
	4-pole, P.U.R.	2 m	CS-A1-02-R-02	95A251540	
		5 m	CS-A1-02-R-05	95A251560	
	8-pole, black, P.V.C.	3 m	CS-A1-06-B-03	95ACC2230	
		5 m	CS-A1-06-B-05	95ACC2240	
		10 m	CS-A1-06-B-10	95ACC2250	
	4-pole, shielded, grey, P.V.C.	3 m	CV-A1-22-B-03	95ACC1480	
		5 m	CV-A1-22-B-05	95ACC1490	
		10 m	CV-A1-22-B-10	95ACC1500	
	8-pole, shielded, black, P.V.C.	3 m	CV-A1-26-B-03	95ACC1510	
		5 m	CV-A1-26-B-05	95ACC1520	
		10 m	CV-A1-26-B-10	95ACC1530	
		15 m	CV-A1-26-B-15	95ACC2080	
		25 m	CV-A1-26-B-25	95ACC2100	
	4-pole, U.L., black, P.V.C.	3 m	CS-A1-02-U-03	95ASE1120	
		5 m	CS-A1-02-U-05	95ASE1130	
		10 m	CS-A1-02-U-10	95ASE1140	
		15 m	CS-A1-02-U-15	95ASE1150	
	8-pole, U.L., black, P.V.C.	25 m	CS-A1-02-U-25	95ASE1160	
		3 m	CS-A1-06-U-03	95ASE1220	
		5 m	CS-A1-06-U-05	95ASE1230	
		10 m	CS-A1-06-U-10	95ASE1240	
		15 m	CS-A1-06-U-15	95ASE1250	
		25 m	CS-A1-06-U-25	95ASE1260	
	4-pole, black	Connector-not cabled	CS-A1-02-B-NC	G5085002	
		8-pole, black	Connector-not cabled	CS-A1-06-B-NC	95ACC2550
	Ethernet cable M12/RJ45	4-pole	3m straight D coded	DATAVS-CV-RJ45D-03	95A901350

S67



ACCURATE AND PRECISE LASER DISTANCE SENSOR WITH SUBMILLIMETRIC RESOLUTION

- Sturdy metal Die-cast zinc IP67 housing.
- Resolution of 10um@50mm. distance on white 90% remission.
- Response time less than 0,9ms (short range models)
- Linearity error of +/-0,03mm@50mm range.
- Analog Voltage models with 0V-10V protected output.
- Analog Current models with 4-20mA protected output.
- Soiling indicator and Alarm Output.
- Robust light interference suppression.

APPLICATIONS

- Automotive Industries
- Textile and Paper Industries
- Wood Industries
- General Packaging Industries
- Metal tooling
- Assembly lines
- Mechanical engineering and Special machinery



S67

Distance sensor (90% White target)		50...300 mm (Y03)
		100...600 mm (Y13)
Linearity error:		±0.03...±1.0 mm (Y03)
		±0.05...±2.0 mm (Y13)
Resolution:		0.01...0.33 mm (Y03)
		0.015...0.67 mm (Y13)
Laser class emission:		RED Laser Diode CLASS 2 According to IEC 60825-1 (2014)
Response time:		< 900 µs long range
Setting		Red LED Alarm/Soiled lens indicator
		Green LED Power indicator
		Push Button Teach in
Power supply:	Vdc	12 -28 VDC +/- 10%
	PNP	-
	NPN	-
	Push pull	-
	other	Analog output: 4...20 mA (-I) 0...10 V (-V)
Connection	connector	Rotatable M12 5poles
Approximate dimensions (mm)		Rectangular 20,6mm x 65mm x 50mm
Housing material		die-cast zinc
Mechanical protection		IP67

TECHNICAL DATA

Power supply	12 –28 VDC +/- 10%
Consumption (output current excluded)	100 mA
Light emission	650 nm Pulsed RED Laser Diode CLASS 2 According to IEC 60825-1 (2014) Complies with 21 CFR 1040.10 and 1040.11
Laser Spot	2 mm Point
Setting	Push Button Teach in
Operating Distance (90% White target)	50...300 mm (Y03) 100...600 mm (Y13)
Linearity error (90% White target)	±0.03...±1.0 mm (Y03) ±0.05...±2.0 mm (Y13)
Resolution (90% White target)	0.01...0.33 mm (Y03) 0.015...0.67 mm (Y13)
Teach-in Range min.	>5mm (Y03) >10mm (Y13)
Indicators	Red LED Alarm/Soiled lens indicator Green LED Power indicator Push Button Teach in
Analog output	Analog Current Output : load resistance (analog I) < (+Vs - 6 V) / 0,02 (-I) Analog Voltage Output : load resistance > 100 kOhm (-V)
Response time	< 900 µs long range
Connection	Rotatable M12 5poles
Dielectric strength	500 Vac, 1 min between electronics and housing
Insulating resistance	>20 MΩ, 500 Vdc between electronics and housing
Mechanical protection	IP67
Ambient light rejection	< 8k Lux (Y03) < 10k Lux (Y13)
Vibrations	0,5 mm amplitude, 10 ... 55 Hz frequency, for every axis (EN60068-2-6)
Shock resistance	11 ms (30 G) 6 shock for every axis (EN60068-2-27)
Housing material	die-cast zinc
Lens material	Glass
Typ. Temperature Drift	± 0.03% of Full Scale Measuring Range / °C
Operating temperature	0...50°C
Storage temperature	-25 ... 70 °C
Tightening torque	1.0 Nm
Weight	180g. max.

DIMENSIONS

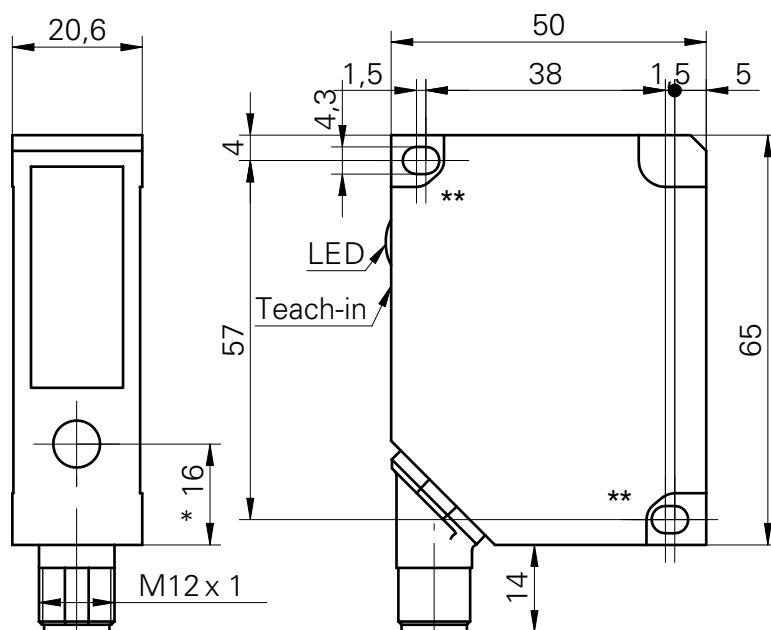

* emitter axis

**Apply tighten torque...<1.0 Nm

CONNECTIONS

S67-MH-5-Y03-I / S67-MH-5-Y13-I

1. (BROWN): +12...28 VDC
2. (WHITE): ANALOGUE OUTPUT- I(4...20mA)
3. (BLUE): 0V
4. (BLACK): NOT USED
5. (GREY): TEACH IN

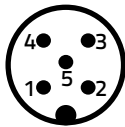

S67-MH-5-Y03-V / S67-MH-5-Y13-V

1. (BROWN): +12...28 VDC
2. (WHITE): ANALOGUE OUTPUT- V(0...10V)
3. (BLUE): 0V
4. (BLACK): NOT USED
5. (GREY): TEACH IN

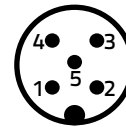

Note: If external Teach-In option is not used, the Teach-In wire must be attached to GND.

Note: Shielded cable is suggested for critical cabling.

Note: Color of wires are referred to European standard.

INDICATORS AND SETTINGS

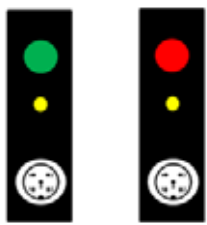

LEDS

RED LED may indicate ALARM or dirty lens surface.
GREEN LED is the POWER indicator.

TEACH IN BUTTON

The yellow button allows the user to teach a new range by optimizing the resolution. It can be used to reset the factory settings.

The S67Y distance sensor is factory set to the maximum measuring range. In order to optimize the resolution and linearity, its Teach-In feature is designed to select a smaller range within the nominal range. If a new range is chosen the Output current, voltage and alarm output will adapt to it.

The sensor must be taught with two specific positions:

- First Teach-In: aligns the position with 0 V (or 4 mA)
- Second Teach-In: aligns the position with 10 V (or 20 mA)

Note: The two positions are always at the border of the new range (within the measuring range).

The red LED gives feedback during a Teach-In session. The red LED located on the back of the sensor, indicates "Run" mode if it detects an object in the measuring range. The S67Y can be set in two different ways: one with Teach-In button and the other one through the external teach input.

The device can be taught more than 10.000 times in its lifetime. The S67Y may be always reset to factory setup.

TEACHING NEW MEASURE	RESET
<p>Seven steps to teaching a new measuring range:</p> <ol style="list-style-type: none"> 1. Press (and hold) the button. The red LED will turn on, if the sensor can be taught. 2. Hold down the button for 5 more sec. The LED will start to blink. 3. Release the button. 4. Place a target at the first new position of the measuring range. This is the position that will later produce 0 V (or 4 mA). 5. Briefly press the button again. The LED will stop blinking and will stay on for about 3 sec to indicate that the first position has been stored. Then the LED will blink again. 6. Now place the target at the second position (the other end of the new range), which will produce 10 V (or 20 mA). 7. Briefly press the button again. The LED will stop blinking and will stay on for about 3 sec to indicate that the second position has been stored. The LED will then turn off and blink once more. <p>Now the sensor is ready to measure.</p> <p>The new, smaller operating range is now set. The red LED now indicates whether an object is within the new range (LED OFF) or not (LED ON). If one of the new borders of the range was outside the standard range or the two positions were too close to each other, then the new settings are not valid. The sensor will respond with an extended blinking at the end of the teach procedure. The previous settings are still valid and the new settings are lost</p>	<ol style="list-style-type: none"> 1. Push the button. The red LED will turn on, if the sensor can be taught. 2. Hold down the button further 5 sec. The LED will start to blink. Do not release the button now. Wait another 10 sec until the LED is ON without blinking. Factory settings have been restored to the sensor. 3. Release the button. <p>Note: If there are missed measurements (up to 30 cycles) these will be suppressed. During this time the analog output stays on hold. Note: For objects with a reflectivity < 7 % (S67-MR-5-Y13...), the response/release time is increased automatically up to max. 2.8 ms.</p>

DETECTION DIAGRAMS

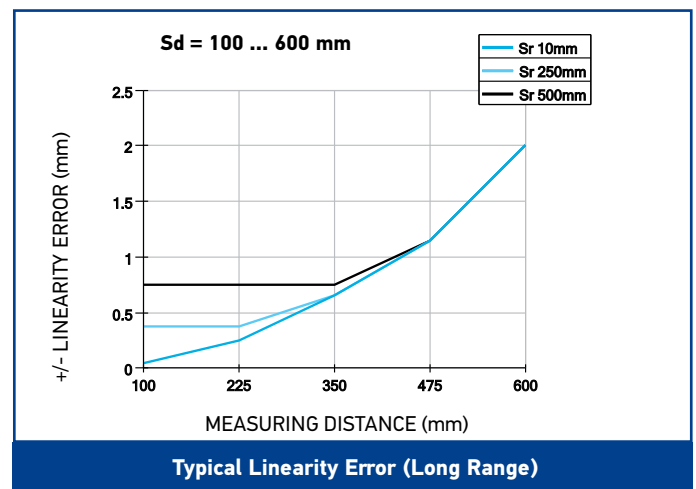
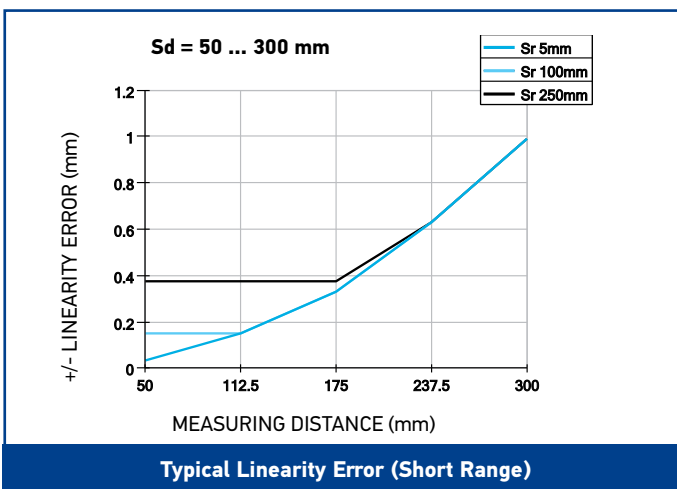
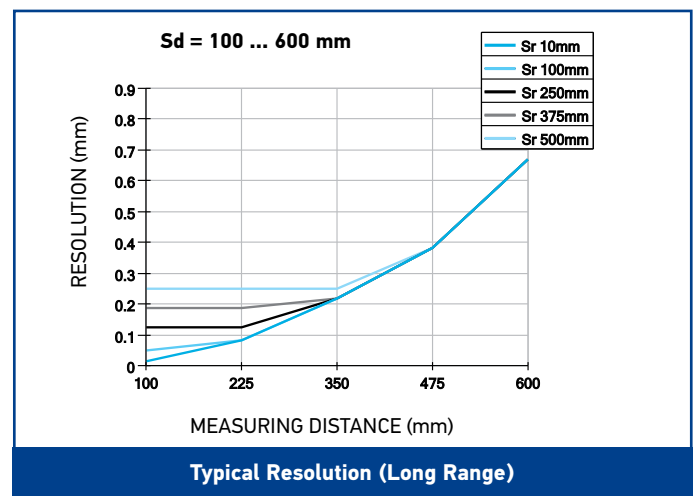
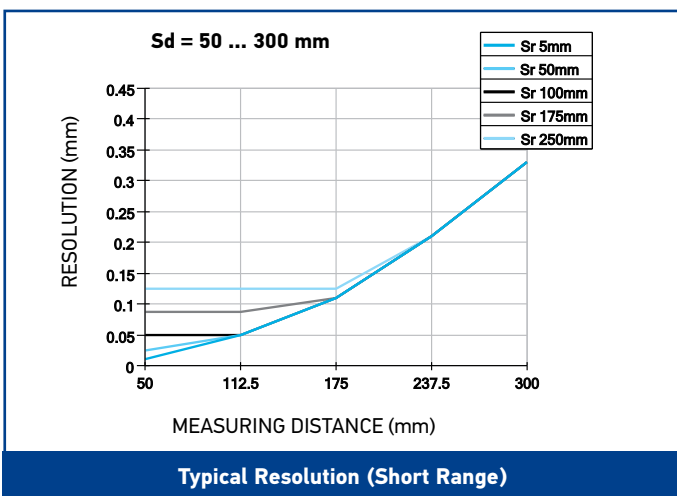
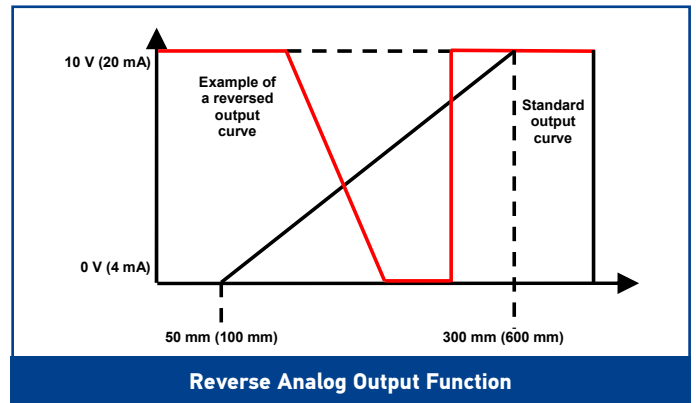
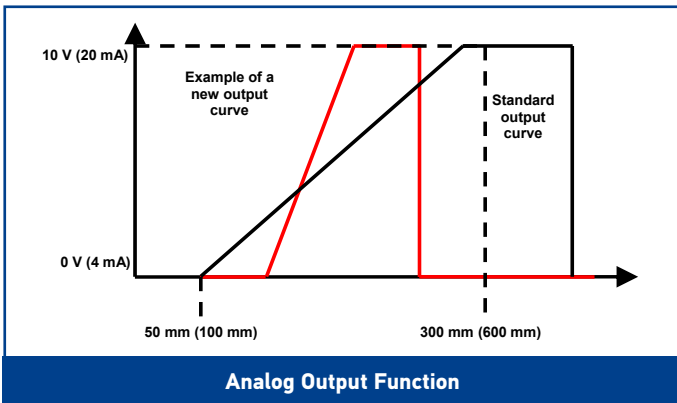

MODEL SELECTION AND ORDER INFORMATION

OPTIC FUNCTION	OPERATING DISTANCE	CONNECTION	OUTPUT & INPUT	MODELS	ORDER No.
Long range Laser Distance Sensor	100...600 mm	M12 5-poles connector	Analog output: 0...10 V (-V)	S67-MH-5-Y13-V	956271030
			Analog output: 4...20 mA (-I)	S67-MH-5-Y13-I	956271010
Short range Laser Distance Sensor	50...300 mm	M12 5-poles connector	Analog output: 0...10 V (-V)	S67-MH-5-Y03-V	956271020
			Analog output: 4...20 mA (-I)	S67-MH-5-Y03-I	956271000

ACCESSORIES

S67Y mounting kit

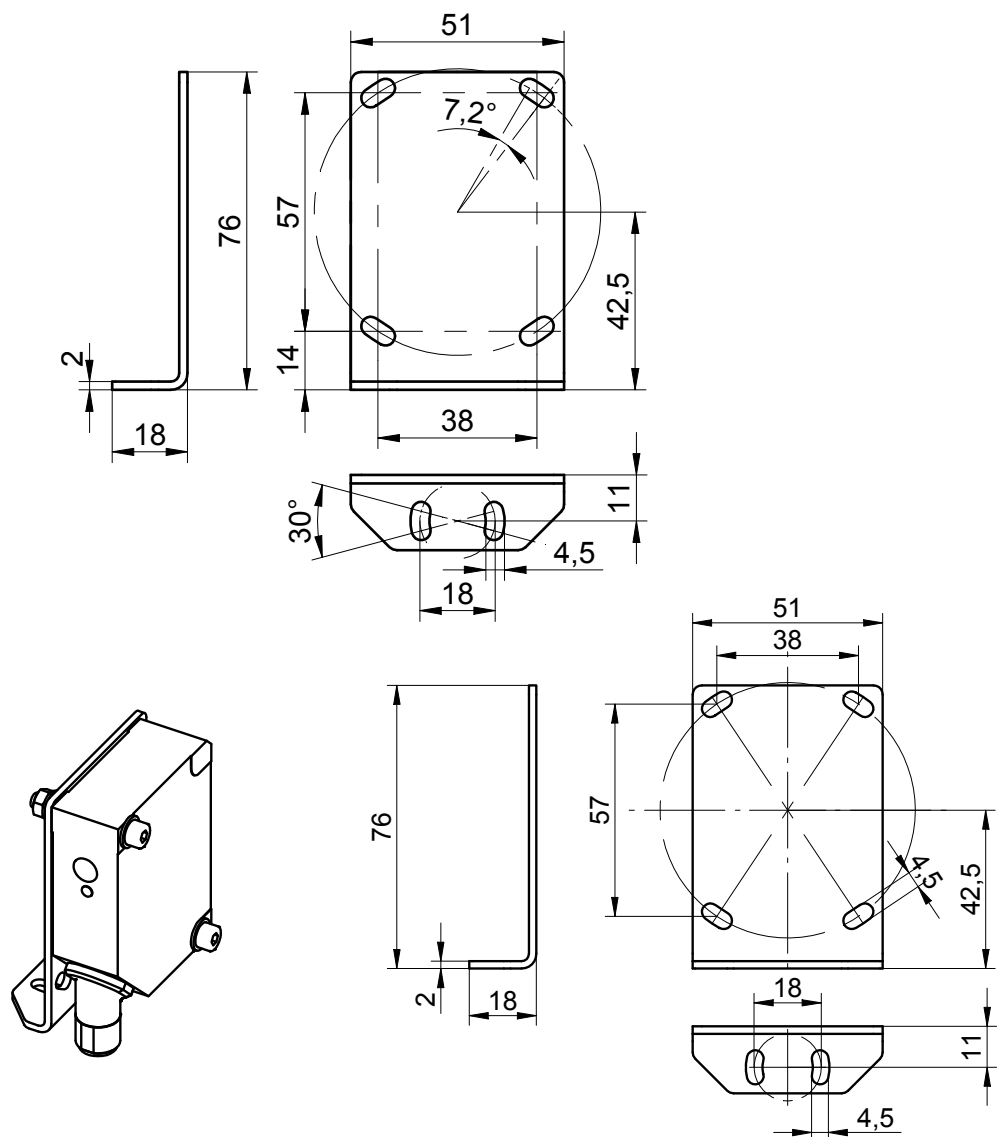

MODEL	DESCRIPTION	ORDER No.
ST-S67Y	S67Y mounting kit	95ACC8160

CABLES

TYPE	DESCRIPTION	LENGTH	MODEL	ORDER No.
Axial M12 connector	5-pole, grey, P.V.C.	3 m	CS-A1-03-G-03	95ACC2110
		5 m	CS-A1-03-G-05	95ACC2120
		10 m	CS-A1-03-G-10	95ACC2140
	5-pole, U.L., black, P.V.C	3 m	CS-A1-03-U-03	95ASE1170
		5 m	CS-A1-03-U-05	95ASE1180
		10 m	CS-A1-03-U-10	95ASE1190

S65-M



TIME OF FLIGHT LONG RANGE BACKGROUND SUPPRESSOR

- Long Range background suppression detection up to 5m
- Cost effective solution for precise and reliable detection
- Risk-free Infrared LED emission and embedded green LED pointer
- Two independent fully programmable outputs
- NPN/PNP or IO-Link connection models
- Rugged plastic housing in compact 50x50x24 mm format

APPLICATIONS

- Presence of all medium and large sized objects on conveyors
- Critical object detection in front of problematic background
- Positioning tasks in palletizing
- Position limiter for deck and robot in automotive manufacturing
- Collision prevention limit switch for AGV applications
- Checking filling level for liquid and objects

		S65-M
Operating Distance		0.3..5 m (90% white) / 0.3..4 m (18% grey) / 0.3..2.5 m (6 % black)
Hysteresis		20mm / 50mm / 80mm
Difference White 90%/Grey 18% and White 90%/Black 6%		see chart (value Typ, 1σ, T=25°C, ambient light <1Klux)
Repeatability error		20mm for distance > 750mm / 40mm for distance <= 750mm (1σ, T=25°C)
Response time		8.5 msec max.T=25°C
Operating Frequency		<65Hz
Setting		Teach-in buttons SET1, SET2
Teach-in Input		Active High (+24V) 1 sec < t < 3 sec = teach Q1 / > 3 sec = teach Q2
Supply voltage	Vdc	24 VDC ± 20%
	Vac	
	Vac/dc	
Switching output	PNP	
	NPN	
	NPN/PNP	Can be set up (PNP NPN / Light Dark) 100mA max.
	relay	
	other	IO-Link V1.1, dual channel IO-Link output with and dual digital output
Connections	cable	
	connector	M12 - 5 poles
	pig-tail	
Exposed material		Body ABS / Display POLYESTER
Front side material		PMMA
Dimensions		50 x 50 x 25 mm
Mechanical protection		IP67
Weight		50 g.max.
UL (requirements)		Class 2 power supply according to UL 508

TECHNICAL DATA

Supply voltage	24 VDC ± 20%
Consumption	< 2.2 W (excluding any loads)
Operating Distance	0.3..5 m (90% white) / 0.3..4 m (18% grey) / 0.3..2.5 m (6 % black)
Hysteresis	20mm / 50mm / 80mm
Response time	8.5 msec max.
Difference White 90%/Grey 18% and White 90%/Black 6%	see chart (value Typ, 1σ, T=25°C, ambient light <1Klux)
Repeatability error	20mm for distance > 750mm / 40mm for distance ≤ 750mm (1σ, T=25°C)
Thermal compensation error	1.5 mm / °C (T ≠ 25°C)
Switching output	Can be set up (PNP NPN / Light Dark) 100mA max.
Teach-in Input	Active High (+24V) 1 sec < t < 3 sec teach Q1 / > 3 sec teach Q2
Warming-up time	20 min typ
Warnings	Q1 (YELLOW) / Q2 (YELLOW) / ON PWR (GREEN) - PNP / NPN (GREEN)
Operating temperature	-15°... +55 °C (with device ON)
Storage temperature	-25 ... +70 °C
Electrical strength	500 VAC, 1 min between electronics and case
Insulation resistance	> 20 M , 500 VDC between electronics and case
Reading spot size	typ 200x200 mm @ 4m
Pointer spot size (green)	typ 250x250 mm @ 4m
Max. deviation of pointer/reading spot axes origin	+/- 40 mm
Emission and Wavelength	LED IR / 850 nm
Ambient light rejection	according to EN 60947-5-2,
Vibrations	width 0.5 mm, frequency 10 ... 55Hz, per axis (EN60068-2-6)
Shock resistance	11 ms (30 G) 6 shocks for each axis (EN60068-2-27)
Humidity	< 90% no condensation
Exposed material	Body ABS / Display POLYESTER
Front side material	PMMA
Mechanical protection	IP67
Connections	M12 - 5 poles
(Overall) Dimensions	50 x 50 x 25 mm
Weight	50 g.max.
I/O LINK Connection	NO (See parameter table on www.datalogic.com)
UL (requirements)	Class 2 power supply according to UL 508

DIMENSIONS

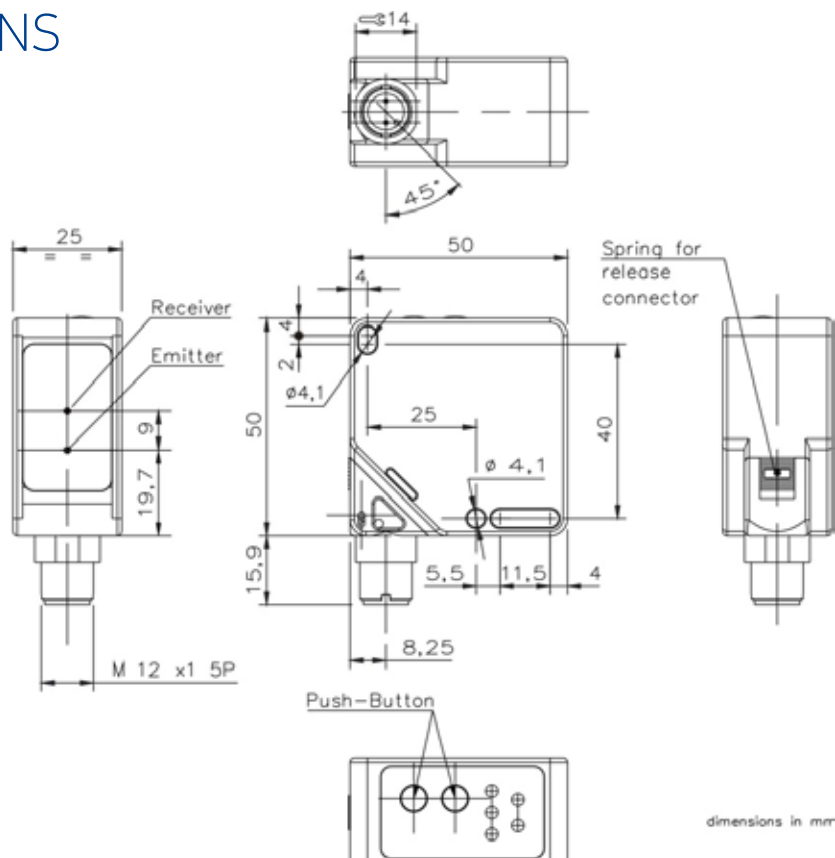

CONNECTIONS

M12 CONNECTOR

S65-PA-5-M13-OO

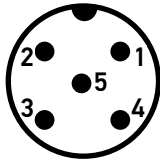

- 1 (BROWN) : +24 V ±20%
- 2 (WHITE) : Q2 100mA max.
- 3 (BLUE) : 0 V
- 4 (BLACK) : Q1 100mA max.
- 5 (GREY) : REMOTE TEACH-IN

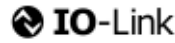

S65-PA-5-M13-OOZ

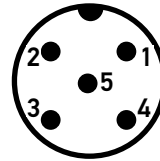

- 1 (BROWN) : +24 V ±20%
- 2 (WHITE) : Q2 100mA max.
- 3 (BLUE) : 0 V
- 4 (BLACK) : C/Q1 (I/O LINK)
- 5 (GREY) : REMOTE TEACH-IN

NOTE: Wire colour refers to European standard.

INDICATORS AND SETTINGS



OUTPUT LED (yellow)

Yellow LEDs, numbered as 1 and 2, indicate activation of Q1 and Q2 outputs.

LEDs blink at the same time if measurement is out of range or not available due to the presence of environmental contamination.

POWER LED (green)

Green PWR LED on indicates that the device is switched on and operating.

ACTIVE SETUP LED (green)

Green PNP/NPN LEDs on indicate that the device is in the selected setup.

SET1 Push Button

Teach-in push button for Q1 and setting parameter menu

SET2 Push Button

Teach-in push button for Q2 and setting parameter menu

DETECTION DIAGRAMS

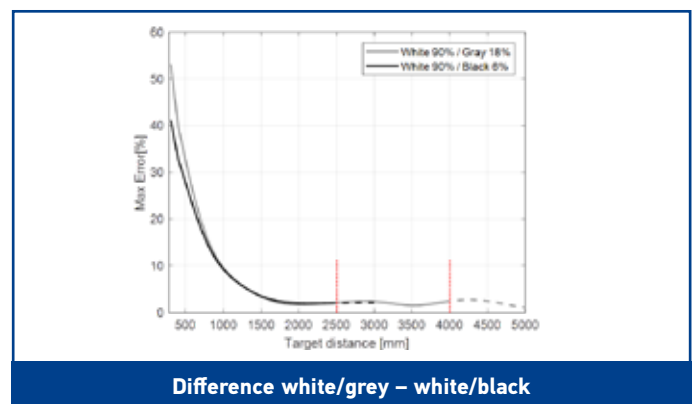
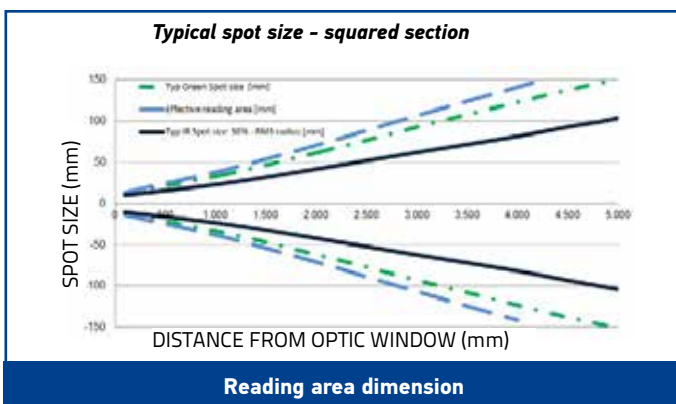

MODEL SELECTION AND ORDER INFORMATION

OPTIC FUNCTION	CONNECTION	OUTPUT	MODEL	ORDER No.
Background Suppression long range IR	M12 5 poles	NPN/PNP	S65-PA-5-M13-00	956251160
	M12 5 poles	 IO-Link	S65-PA-5-M13-00Z	956251170

ACCESSORIES

ST-5020

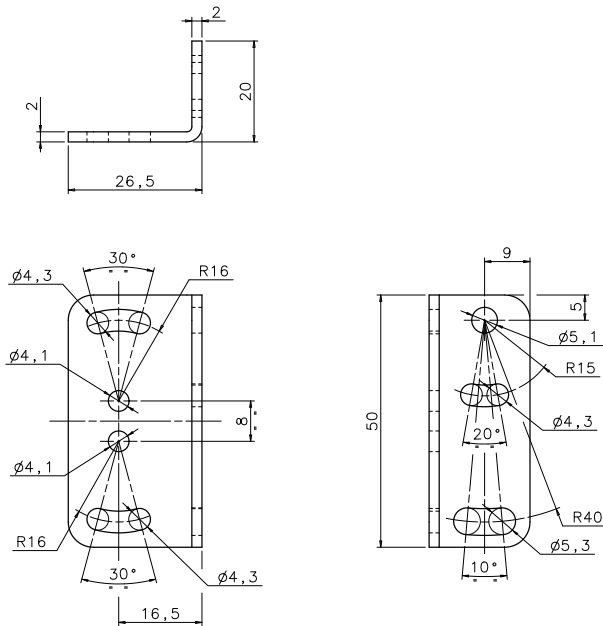

ST-5021

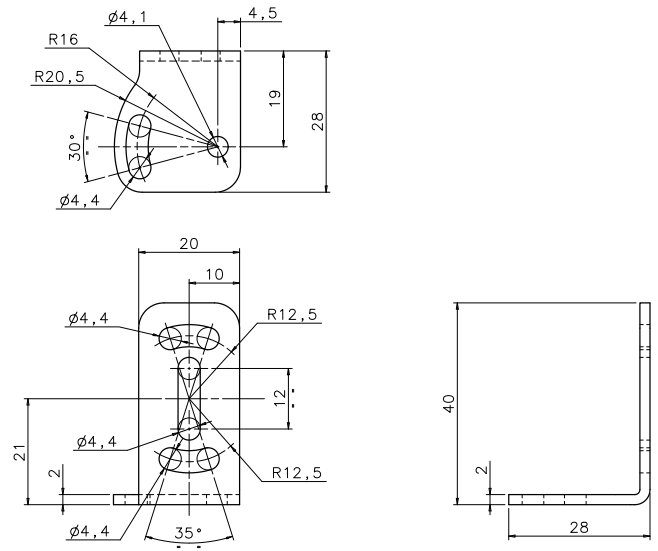

MODEL	DESCRIPTION	ORDER No.
ST-5020	mounting bracket 50 x 27 x 20 mm	95ACC5330
ST-5021	mounting bracket 20 x 40 x 28 mm	95ACC5340

CABLES

TYPE	DESCRIPTION	LENGTH	MODEL	ORDER No.
Axial M12 Connector	M12 5-pole conn. with 3 m unshielded cable	3 m	CS-A1-03-G-03	95ACC2110
	M12 5-pole conn. with 5 m unshielded cable	5 m	CS-A1-03-G-05	95ACC2120
	M12 5-pole conn. with 10 m unshielded cable	10 m	CS-A1-03-G-10	95ACC2140
Axial M12 F/M8 M Connector	5-pole, L coded power cable	3 m	CS-M1-02-B-03	95ACC0007
	4-pole, double headed	3 m	CS-H1-02-B-03	95ACC0008
Axial M12 F/M12 M Connector	4-pole, double headed	3 m	CS-I1-02-B-03	95ACC0009

S85



LASER DISTANCE SENSOR FOR PRECISE MEASUREMENT UP TO 20 M WITH MILLIMETRIC RESOLUTION AND REPEATABILITY THROUGH THE TIME OF FLIGHT TECHNOLOGY

- Direct Time Of Flight Technology
- Class 2 visible red LASER for an easy alignment with the target
- Measuring range up to 10m or 20m in the advanced model
- 1 mm resolution, 7 mm accuracy, 1 mm repeatability
- 4-20 mA or 0-10 V scalable analog output and 2 digital outputs
- RS485 serial interface in the advanced model
- Standard M12 connector
- IP67 Industrial metal housing



APPLICATIONS

- Automated warehousing
- Processing and Packaging machinery
- Industrial vehicles
- Automotive

S85

Distance sensor (90% White target)		0,2...20 m (S85...Y13)
		0,2...10 m (S85...Y03)
Repeatability		1...2 mm
Accuracy		7...10 mm
Resolution		1 mm
Light emission		red LASER (class 2)
Response time		30 ms (S85...Y03)
		15...30 ms (S85...Y13)
Serial interface		RS485 (S85...Y13)
Setting		Display (S85...Y13)
		push-buttons (S85...Y03)
Power supply	Vdc	24 Vdc +/- 20%
Output	PNP	•
	NPN	•
	Push pull	•
	other	Analog output: 4...20 mA or 0...10 V
Connection	connector	•
Approximate dimensions (mm)		60x72x37
Housing material		Zamak
Mechanical protection		IP67

TECHNICAL DATA

Power supply	24 Vdc ± 20%
Consumption (output current excluded)	2,8 W max. (mod. S85...Y03) 3 W max. (mod. S85...Y13)
Light emission	red Laser 658 nm
Setting	push-buttons (mod. S85...Y03) push-buttons and display (mod. S85...Y13)
Operating distance	90% white target 0,2...10 m (mod. S85...Y03), 0,2...20 m (mod. S85...Y13) 18% grey target 0,2...5 m (mod. S85...Y03), 0,2...8 m (mod. S85...Y13) 6% black target 0,2...3 m (mod. S85...Y03), 0,2...5 m (mod. S85...Y13)
Indicators	yellow Q1 LED, Q2 LED green/red POWER/OUT OF RANGE LED 5-digit multi display (mod. S85...Y13)
Output	push pull/Q (mod. S85...Y03) PNP, NPN, push pull, Q, Qneg (mod. S85...Y13)
Analog output	0-10 V (mod. S85...Y03-OOV) 4-20 mA (mod. S85...Y03-OOI) 0-10 V/4-20 mA (mod. S85...Y13-OOIVY)
Response time	slow 45 ms (mod. S85...Y13) medium 30 ms fast 15 ms (mod. S85...Y13)
Connection	M12 5-pole connector (mod. S85...Y03), M12 8-pole connector (mod. S85...Y13)
Dielectric strength	500 Vac, 1 min between electronics and housing
Insulating resistance	>20 MΩ, 500 Vdc between electronics and housing
Mechanical protection	IP67
Ambient light rejection	according to EN 60947-5-2, >40 Klux DC ambient light
Vibrations	0,5 mm amplitude, 10 ... 55 Hz frequency, for every axis (EN60068-2-6)
Shock resistance	11 ms (30 G) 6 shock for every axis (EN60068-2-27)
Housing material	ZINC ALLOY ZAMA 13 EN-1774/PC LEXAN 121R display
Lens material	PMMA
Operating temperature	-15 ... 50 °C
Storage temperature	-25 ... 70 °C
Weight	250 g max.

DIMENSIONS

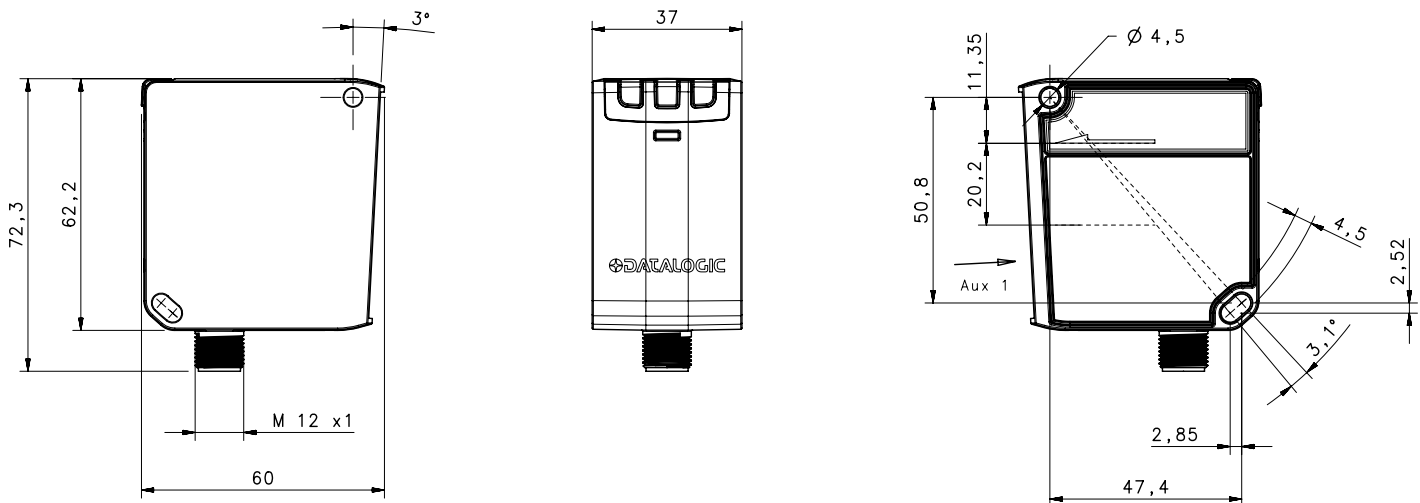

CONNECTIONS

M12 CONNECTOR - STANDARD

S85-Y03-00V
Voltage version

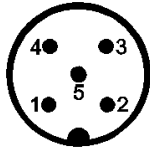

- 1 (BROWN): +24 V ± 20 %
- 2 (WHITE): Q2 100mA max.
- 3 (BLUE): 0 V
- 4 (BLACK): Q1 100mA max.
- 5 (GREY): ANALOG. OUT 0-10V

S85-Y03-00I
Current version

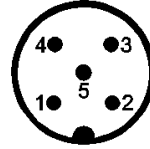

- 1 (BROWN): +24 V ± 20 %
- 2 (WHITE): Q2 100mA max.
- 3 (BLUE): 0 V
- 4 (BLACK): Q1 100mA max.
- 5 (GREY): ANALOG. OUT 4-20mA

M12 CONNECTOR - ADVANCED

S85-Y13-00IVY
Analog version

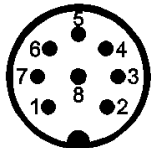

- 1 (WHITE): RS485 -
- 2 (BROWN): +24 V ± 20 %
- 3 (GREEN): ANALOGUE OUT
- 4 (YELLOW): Q1 100mA max.
- 5 (GREY): Q2 100mA max.
- 6 (PINK): RS485 +
- 7 (BLUE): 0 V
- 8 (RED): MULTIFUNC.INPUT

S85-Y13-00Y

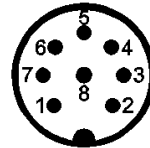

- 1 (WHITE): RS485 -
- 2 (BROWN): +24 V ± 20 %
- 3 (GREEN): RESERVED
- 4 (YELLOW): Q1 100mA max.
- 5 (GREY): Q2 100mA max.
- 6 (PINK): RS485 +
- 7 (BLUE): 0 V
- 8 (RED): MULTIFUNC.INPUT

INDICATORS AND SETTINGS

Without the procedure setting the sensor is configured to measure distances on a white target from a minimum value of 200 mm and a maximum of 20000 mm, with both switching point placed at 500 mm.

The parameters can be changed by the menu on the display pointing the LASER on the target in the different interested points.

INDICATORS

- LED 1 | Q1 (yellow)
- LED 2 | Q2 (yellow)
- LED 3 | POWER ON (green),
OUT OF RANGE (red)



1 2 3

DISPLAY

- Run/W.UP → Run mode or Warm-up mode
- Q+Q → Digital Output setting → PNP/NPN/Push-Pull
- I/V → Analog Output Setting → Ampere/Volt
- Lock Symbol → Keylock or unlock
- 5-digit display → Value corresponds to Distance in mm

MENU	FUNCTIONS
OUT 1	Switching point 1: Light/Dark; Switching point value; PNP, NPN, Push-pull; Alarm
OUT 2	Switching point 2: Light/Dark; Switching point value; PNP, NPN, Push-pull; Alarm
HYSTERESIS	Hysteresis level: 5...1000 mm
ANALOG OUT	Voltage (0...10 V); Current (4...20 mA)
MULTIFUNCTION IN	LASER OFF; Teach IN (Thresholds); RS485 Send Data
AVERAGE	Response time: SLOW; MEDIUM; FAST
RS485	Node N°; Enable; Termination; Output mode; Delay (0...254 ms)
SCALABLE OUT	Analog output range: Reset, MIN and MAX distance
FACTORY RESET	Factory default values
INFO	Software version

DETECTION DIAGRAMS

CURRENT ANALOG OUTPUT

MEASUREMENT RANGE (4...20 mA)
OUT OF RANGE (3,95...4 mA; 20...20,5 mA)

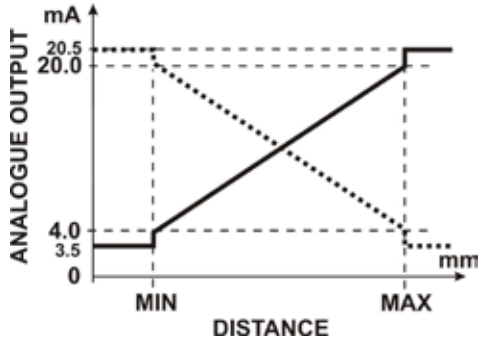

VOLTAGE ANALOG OUTPUT

MEASUREMENT RANGE (0...10 V)

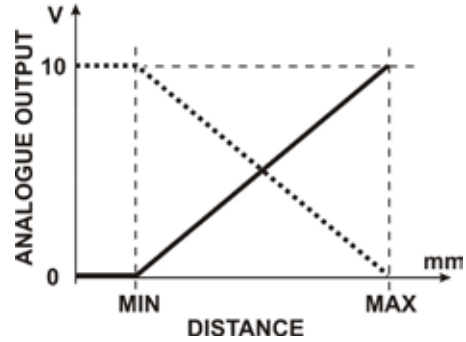

S85-...-Y13 ADVANCED REPEATABILITY (SLOW MODE)

[WHITE 90%; GREY 18%; BLACK 6%]

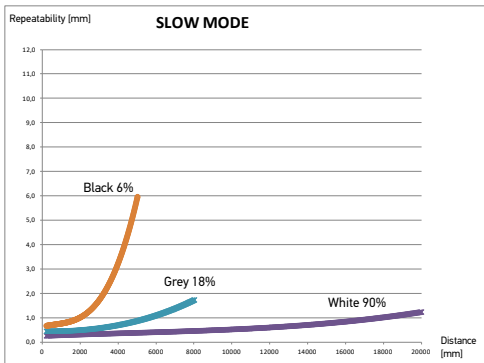

S85-...-Y13 ADVANCED REPEATABILITY (MEDIUM MODE)

[WHITE 90%; GREY 18%; BLACK 6%]

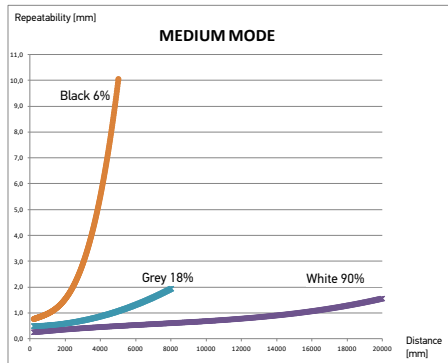

S85-...-Y13 ADVANCED REPEATABILITY (FAST MODE)

[WHITE 90%; GREY 18%; BLACK 6%]

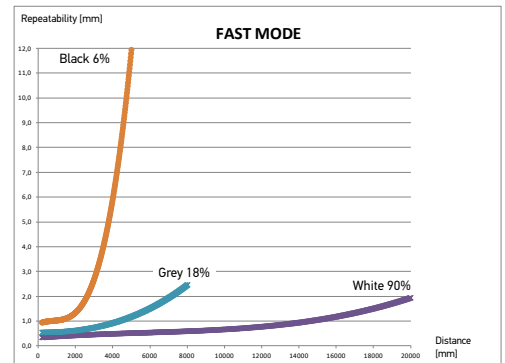

S85-...-Y13 ADVANCED REPEATABILITY/RESPONSE TIME

(90% WHITE TARGET @ 20 m)

MODE	RESPONSE TIME	REPEATABILITY
Slow	45 ms	< 1,5 mm
Medium	30 ms	1,5 mm
Fast	15 ms	< 2 mm

HYSTERESIS

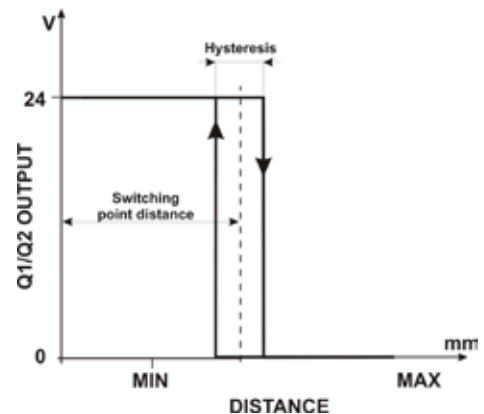

MODEL SELECTION AND ORDER INFORMATION

OPTIC FUNCTION	OPERATING DISTANCE	CONNECTION	OUTPUT & INPUT	MODELS	ORDER No.
Distance sensor (Standard)	10 m	M12 5-pole connector	2 Digital outputs; Analog output: Voltage (0...10 V)	S85-MH-5-Y03-00V	951511010
			2 Digital outputs; Analog output: Current (4... 20mA)	S85-MH-5-Y03-00I	951511030
Distance sensor (Advanced)	20 m	M12 8-pole connector	2 Digital outputs; Analog output: Current (4... 20mA) or Voltage (0...10 V); RS485; Multifunction input	S85-MH-5-Y13-00IVY	951511020
			2 Digital outputs; RS485; Multifunction input	S85-MH-5-Y13-00Y	951511040

ACCESSORIES

ST-S85-STD

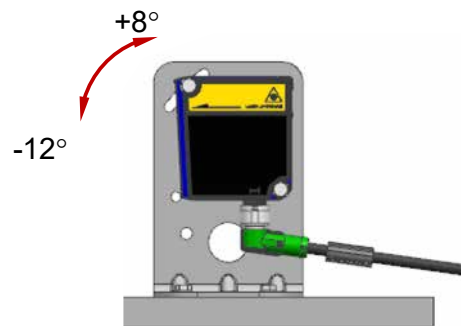
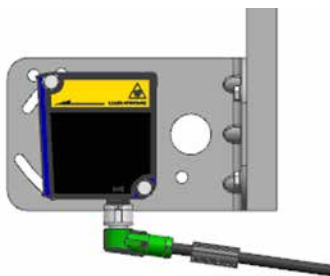
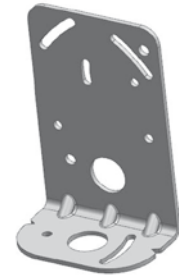
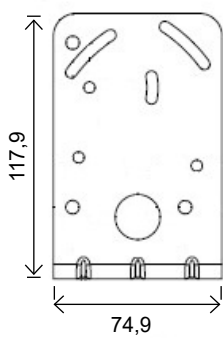

MODEL	DESCRIPTION	ORDER No.
ST-S85-STD	mounting bracket	95ACC7840

CABLES

TYPE	DESCRIPTION	LENGTH	MODEL	ORDER No.	
Axial M12 connector	5-pole, grey, P.V.C.	3 m	CS-A1-03-G-03	95ACC2110	
		5 m	CS-A1-03-G-05	95ACC2120	
		10 m	CS-A1-03-G-10	95ACC2140	
	5-pole, U.L., black, P.V.C	3 m	CS-A1-03-U-03	95ASE1170	
		5 m	CS-A1-03-U-05	95ASE1180	
		10 m	CS-A1-03-U-10	95ASE1190	
		15 m	CS-A1-03-U-15	95ASE1200	
		25 m	CS-A1-03-U-25	95ASE1210	
		50 m	CS-A1-03-U-50	95A252700	
Axial M12 Connector	8-pole, black, P.V.C.	3 m	CS-A1-06-B-03	95ACC2230	
		5 m	CS-A1-06-B-05	95ACC2240	
		10 m	CS-A1-06-B-10	95ACC2250	
Radial M12 Connector		3 m	CV-A2-26-B-03	95ACC1600	
		5 m	CV-A2-26-B-05	95ACC1610	
		10 m	CV-A2-26-B-10	95ACC1620	
Axial M12 Connector	8-pole, shielded, black, P.V.C.	3 m	CV-A1-26-B-03	95ACC1510	
		5 m	CV-A1-26-B-05	95ACC1520	
		10 m	CV-A1-26-B-10	95ACC1530	
		15 m	CV-A1-26-B-15	95ACC2080	
		25 m	CV-A1-26-B-25	95ACC2100	
	8-pole, U.L., black, P.V.C.	3 m	CS-A1-06-U-03	95ASE1220	
		5 m	CS-A1-06-U-05	95ASE1230	
		10 m	CS-A1-06-U-10	95ASE1240	
15 m		CS-A1-06-U-15	95ASE1250		
25 m		CS-A1-06-U-25	95ASE1260		
50 m		CS-A1-06-U-50	95A252710		
	8-pole, black	Connector-not cabled	CS-A1-06-B-NC	95ACC2550	

SR23



HIGH EFFICIENCY FORK SENSOR FOR BOOKLET AND MULTILAYER LABELS DETECTION

- Multilayer labels detection
- Up to 0,5 mm of minimum size labels/gap
- 5 mm slot width
- 50 mm slot depth
- Dynamic or static setting through single push-button
- 12 kHz switching frequency
- Compact and robust housing, IP65
- M8 connector or 2 m cable models
- PNP or NPN models



APPLICATIONS

- Processing and Packaging machinery
- Automatic labelers

SR23

Slot width		5 mm
Slot depth		50 mm
Switching frequency		12 kHz
Light emission		IR LED
Setting		push button
Power supply	Vdc	10...30 Vdc
	Vac	
	Vac/dc	
Output	PNP	•
	NPN	•
	NPN/PNP	
	relay	
	other	
Connection	cable	•
	connector	•
	pig-tail	
Approximate dimensions (mm)		30x63x10
Housing material		Aluminum (Zama), Plastic (PBT)
Mechanical protection		IP65

TECHNICAL DATA

Power supply	10 ... 30 Vdc (reverse polarity protection)
Ripple	2 Vpp max.
Consumption (output current excluded)	30 mA max.
Light emission	IR LED 850 nm
Setting	SET push-button
Indicators	yellow OUTPUT LED green READY LED
Output	PNP or NPN
Output current	100 mA max.
Saturation voltage	2 V max.
Slot width	5 mm
Slot depth	50 mm
Minimum label width	0,5...2 mm
Minimum space between labels	0,5...2 mm
Speed of the conveyor during setting procedure	20 m/min (30 cm/s) max.
Response time	40 µs max.
Switching frequency	12 kHz max.
Connection	M8 4-pole connector, 2 m cable
Dielectric strength	500 Vac, 1 min between electronics and housing
Insulating resistance	> 20 MΩ, 500 Vdc between electronics and housing
Mechanical protection	IP65
Ambient light rejection	according to EN 60947-5-2
Vibrations	0,5 mm amplitude, 10 ... 55 Hz frequency, for every axis (EN60068-2-6)
Shock resistance	11 ms (30 G) 6 shock for every axis (EN60068-2-27)
Housing material	Aluminum (Zama)
Cover material	PBT
Lens material	PC
Operating temperature	-20 ... 55°C
Storage temperature	-20 ... 70°C
Weight	85 g cable vers., 46 g M8 conn. vers.

DIMENSIONS

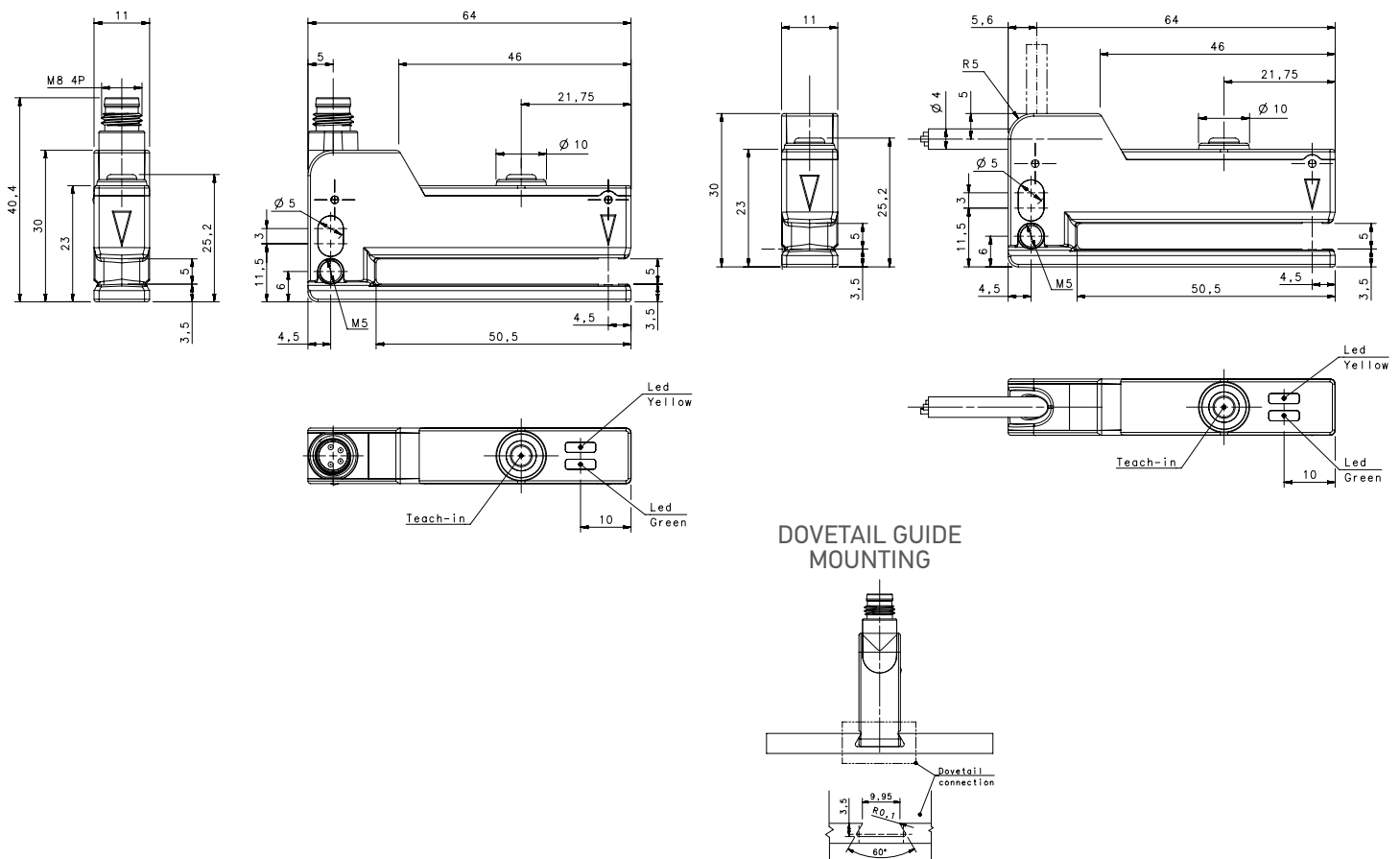

INDICATORS AND SETTINGS

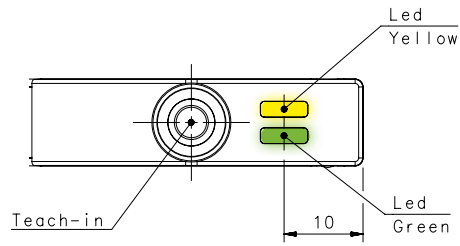

CONNECTIONS

M8 CONNECTOR



CABLE

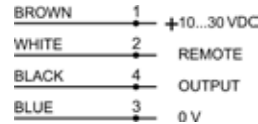

MODEL SELECTION AND ORDER INFORMATION

OPTIC FUNCTION	CONNECTION	OUTPUT	MODEL	ORDER No.
Fork Sensor	2m Cable	PNP	SR23-2-IR-PH	953161000
		NPN	SR23-2-IR-NH	953161020
	M8 Connector	PNP	SR23-5-IR-PH	953161010
		NPN	SR23-5-IR-NH	953161030

CABLES

TYPE	DESCRIPTION	LENGTH	MODEL	ORDER No.
Axial M8 Connector	4-pole, grey, P.V.C.	3 m	CS-B1-02-G-03	95A251420
		5 m	CS-B1-02-G-05	95A251430
		7 m	CS-B1-02-G-07	95A251440
		10 m	CS-B1-02-G-10	95A251480
	4-pole, P.U.R.	2 m	CS-B1-02-R-02	95A251620
		5 m	CS-B1-02-R-05	95A251640
Radial M8 Connector	4-pole, grey, P.V.C.	3 m	CS-B2-02-G-03	95A251450
		5 m	CS-B2-02-G-05	95A251460
		7 m	CS-B2-02-G-07	95A251470
		10 m	CS-B2-02-G-10	95A251530
	4-pole, P.U.R.	2 m	CS-B2-02-R-02	95A251630
		5 m	CS-B2-02-R-05	95A251650

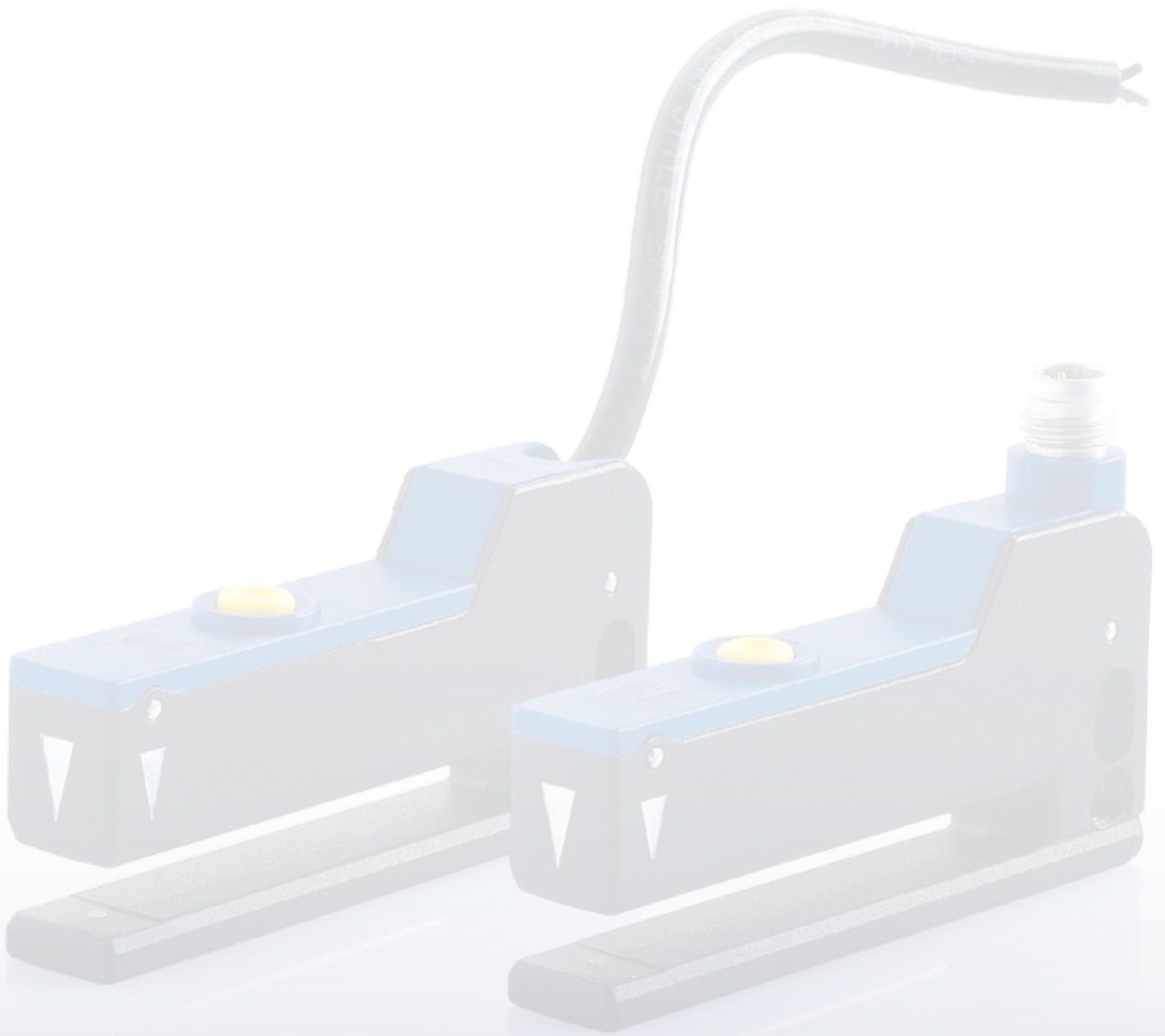

SRF



ULTIMATE PRECISION USING LED OR LASER EMISSIONS FOR HIGH RESOLUTION

- Visible red emission models
- High resolution LASER models
- Sensitivity adjustment trimmer and dark/light selectors
- Industrial metal housing with glass lenses

APPLICATIONS

- Packaging and labeling machinery
- Automotive
- Packaging lines



SRF-30/50/80/120	
Slot width	30 mm (SRF-30)
	50 mm (SRF-50)
	80 mm (SRF-80)
	120 mm (SRF-120)
Slot depth	34 mm (SRF-30)
	54 mm (SRF-50/80/120)
Switching frequency	1,5 kHz
	5 kHz (class 2 LASER)
Light emission	red LED
	red LASER (class 2)
Setting	trimmer
Power supply	Vdc
	Vac
	Vac/dc
Output	PNP
	NPN
	NPN/PNP
	relay
	other
Connection	cable
	connector
	pig-tail
Approximate dimensions (mm)	10x50x59 (SRF-30)
	10x70x79 (SRF-50)
	10x100x79 (SRF-80)
	10x140x84 (SRF-120)
Housing material	Aluminium
Mechanical protection	IP67

TECHNICAL DATA

Power supply	10 ... 30 Vdc (reverse polarity protection)
Ripple	2 Vpp max.
Consumption (output current excluded)	35 mA max. 20 mA max. (Laser mod.)
Light emission	red LED 640 nm red Laser 650 nm
Setting	sensitivity trimmer and N.O./N.C. trimmer
Operating mode	LIGHT/DARK configurable
Indicators	yellow LED
Output	PNP or NPN; NO; NC
Output current	200 mA max.
Saturation voltage	3 V max. PNP, 2,5 V max. NPN
Response time	333 µs 100 µs (Laser mod.)
Switching frequency	1,5 kHz 5 kHz (Laser mod.)
Connection	M8 3-pole connector
Dielectric strength	500 Vac, 1 min between electronics and housing
Insulating resistance	>20 MΩ, 500 Vdc between electronics and housing
Electrical protection	class 1
Mechanical protection	IP67
Ambient light rejection	5 kLux
Vibrations	0,5 mm amplitude, 10 ... 55 Hz frequency, for every axis (EN60068-2-6)
Shock resistance	11 ms (30 G) 6 shock for every axis (EN60068-2-27)
Slot width	30, 50, 80, 120 mm
Resolution	0,3 mm (mod. SRF...30), 0,5 mm (mod. SRF...50/80), 0,8 mm (mod. SRF...120) 0,05 mm (Laser mod. SRF...30), 0,08 mm (Laser mod. SRF...50), 0,1 mm (Laser mod. SRF...80), 0,15 mm (Laser mod. SRF...120)
Housing material	Gd-Zn Alloy
Lens material	glass
Operating temperature	-10 ... 60 °C
Storage temperature	-20 ... 70 °C
Weight	36 g (mod. SRF...30), 54 g (mod. SRF...50), 77 g (mod. SRF...80), 118 g (mod. SRF...120) 66 g (Laser mod. SRF...30), 110 g (Laser mod. SRF...50), 135 g (Laser mod. SRF...80), 210 g (Laser mod. SRF...120)

DIMENSIONS

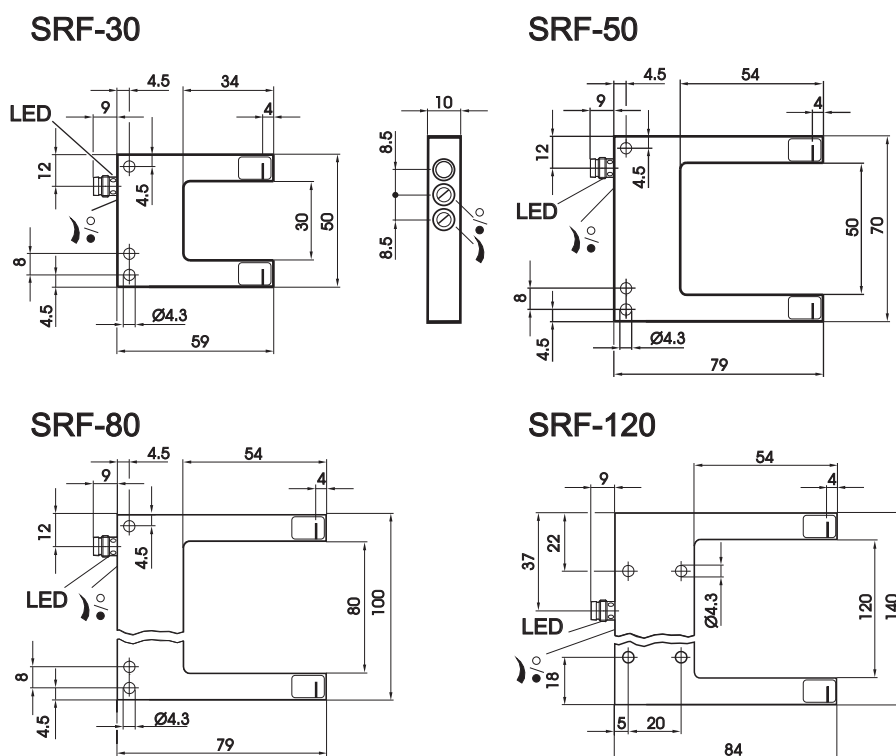

INDICATORS AND SETTINGS

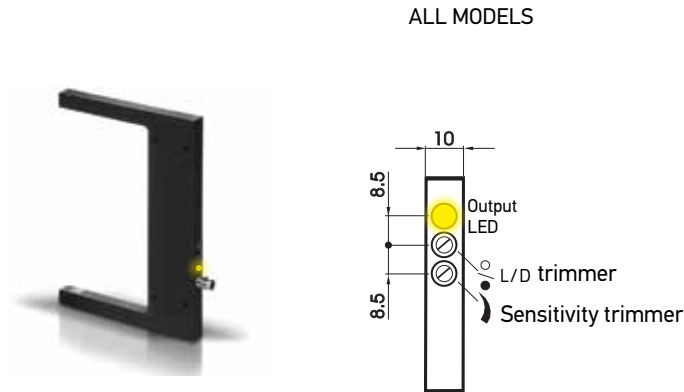

CONNECTIONS

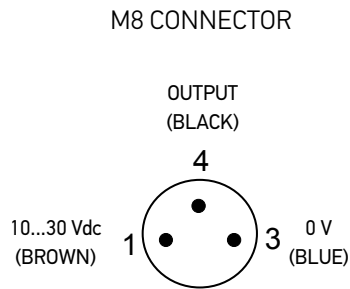

MODEL SELECTION AND ORDER INFORMATION

OPTIC FUNCTION	EMISSION	CONNECTION	OUTPUT	MODEL	ORDER No.
Fork sensor (30 mm)	Red LED	M8 Connector	PNP	SRF-30-5-P	95B020050
	LASER		NPN	SRF-30-5-N	95B020090
Fork sensor (50 mm)	Red LED	M8 Connector	PNP	SRF-L-30-5-P	95B020130
	LASER		PNP	SRF-50-5-P	95B020060
Fork sensor (80 mm)	Red LED	M8 Connector	NPN	SRF-50-5-N	95B020100
	LASER		PNP	SRF-L-50-5-P	95B020140
Fork sensor (120 mm)	Red LED	M8 Connector	PNP	SRF-80-5-P	95B020070
	LASER		NPN	SRF-80-5-N	95B020110
Fork sensor (120 mm)	Red LED	M8 Connector	PNP	SRF-L-80-5-P	95B020150
	LASER		PNP	SRF-120-5-P	95B020080
Fork sensor (120 mm)	Red LED	M8 Connector	NPN	SRF-120-5-N	95B020120
	LASER		PNP	SRF-L-120-5-P	95B020160

CABLES

TYPE	DESCRIPTION	LENGTH	MODEL	ORDER No.
Axial M8 connector	3-pole, Grey, P.V.C.	3 m	CS -B1-01-G-03	95A251490
		5 m	CS -B1-01-G-05	95A251510
Radial M8 connector		3 m	CS -B2-01-G-03	95A251500
		5 m	CS -B2-01-G-05	95A251520

TL46



ULTRA HIGH SPEED HIGH PERFORMING CONTRAST SENSOR FOR COLORED REGISTRATION MARK DETECTION

- Ultra Fast model up to 70 kHz and very low 3us jitter (TL46-WH...OZ)
- Color mode enhanced model (TL46-WE)
- Position mounting monitoring through IO-Link communication
- Mechanical vibration monitoring through IO-Link communication
- Wide-spectrum RGB or white LED emission
- 7 different models: basic, standard, enhanced, low jitter, color mode, basic IO-Link, ultra fast with IO-Link
- Automatic, manual and dynamic settings
- 10, 15, 20, 30, 50, 70 kHz switching frequencies
- Very low 3us jitter for fast and very precise detection (TL46-WH...OZ)
- NPN/PNP/PP and analog outputs
- IO-Link connectivity V1.1.2 with smart functions
- Standard mounting, M12 connector rotatable to 5 positions

APPLICATIONS

- Packaging and labeling machinery
- Beverage/Food/Cosmetic/Pharmaceutical industries
- Printing machinery
- Flexographic printing machinery
- Very high precision for cutting and sealing applications

(**) ATEXII 3DG

TL46	
Contrast sensor	9 ±3 mm
	18 mm (Lens No.18 glass)
	22 mm (Lens No.22 glass)
	28 mm (Lens No.28 glass)
	40 mm (Lens No.40 glass)
Switching frequency	10 kHz (mod. TL46-WE color mode)
	15 kHz (mod. TL46-W)
	20 kHz (mod. TL46-A/WL)
	25 kHz (mod. TL46-W...PZ)
	30 kHz (mod. TL46-WLF/WE contrast mode)
	50 kHz (mod. TL46-WJ)
	70 kHz (mod. TL46-WH...PZ)
Jitter	50 µs (mod. TL46-WE color mode)
	33 µs (mod. TL46-W)
	25 µs (mod. TL46-A/WL)
	<20 µs (mod. TL46-W...PZ)
	16 µs (mod. TL46-WLF/WE contrast mode)
Light emission	<7 µs (mod. TL46-WJ)
	<3 µs (mod. TL46-WH...PZ)
	RGB LED white LED Red LED
Setting	push buttons
	Trimmer (precise incremental encoder) mod. TL46-A
Power supply	10...30 V
	VDC VAC VAC/DC
Output	PNP
	NPN
	NPN/PNP
	relay
	Analogue out
Connection	0...5 V Analogue Output (TL46-A/W/WL only)
	IO-Link V1.1.2 Smart sensor profile double channel I/O (mod. TL46-WH...PZ, TL46-W...PZ)
Approximate dimensions (mm)	IO-Link
	cable
	connector
Housing material	pig-tail
	Aluminium
Mechanical protection	IP67

TECHNICAL DATA

Power supply	10 ... 30 VDC (limit values)
Ripple	2 VPP max.
Consumption (output current excluded)	40 mA max. at 24 VDC (mod. TL46-A) 50 mA max. at 24 VDC (mod. TL46-W/WJ) 85 mA max. at 24 VDC with bargraph ON in threshold adjustment mode, 55 mA max at 24 VDC with bargraph OFF in normal functioning mode (mod. TL46-WL) 35 mA max. at 24 VDC (mod. TL46-WLF/WE) 30mA (mod. TL46-WH...PZ, TL46-W...PZ)
Light emission	white LED 400-700 nm (mod. TL46-A-4xx); red LED 630 nm (mod. TL46-A-6xx) blue LED 465nm/green LED 520 nm/red LED 630 nm (mod. TL46-W/WL/WLF/WE/WJ/WH...PZ/W...PZ)
Detection Distance	9 ±3 mm 18 mm (Lens No.18 glass) 22 mm (Lens No.22 glass) 28 mm (Lens No.28 glass) 40 mm (Lens No.40 glass)
Minimum spot dimension	1.5 x 5 mm; 0.8 x 4 mm (TL46-WJ, TL46-WH...PZ, TL46-W...PZ)
Depth of field	± 3 mm
Response time	100 µs (mod. TL46-WE, TL46-WH...PZ color mode) 33 µs (mod. TL46-W) 25 µs (mod. TL46-A/WL) 20 µs (mod. TL46-W...PZ) 16 µs (mod. TL46-WLF/WE contrast mode) 10 µs (mod. TL46-WJ) 6 µs (mod. TL46-WH...PZ)
Switching frequency	10 kHz (mod. TL46-WE, TL46WH...PZ color mode) 15 kHz (mod. TL46-W) 20 kHz (mod. TL46-A/WL) 30 kHz (mod. TL46-WLF/WE contrast mode) 50 kHz (mod. TL46-WJ) 70 kHz (mod. TL46-WH...PZ)
Jitter	50 µs (mod. TL46-WE, TL46-WH...OZ color mode) 33 µs (mod. TL46-W) 25 µs (mod. TL46-A/WL) 20 µs (mod. TL46-W...PZ) 16 µs (mod. TL46-WLF/WE contrast mode) <7 µs (mod. TL46-WJ) 3 µs (mod. TL46-WH...PZ)
Setting	SET push-buttons (mod. TL46-W/WL/WLF/WH...PZ/W...PZ) sensitivity trimmer (mod. TL46-A)
Operating mode	DARK/LIGHT selection by switch (mod. TL46-A); automatic DARK/LIGHT selection (mod. TL46-W/WL/WJ) automatic DARK/LIGHT selection in the target/background detection, selectable via wire in the dynamic detection (mod. TL46-WLF/WE/WH)
Indicators	yellow OUTPUT LED green READY LED, orange DELAY LED and KEYLOCK (mod TL46-W/WJ/W...PZ) green READY LED, 4-digit display/DELAY LED/KEYLOCK LED mod. TL46-WLF/WE/WH...PZ orange ARROWS (mod. TL46-A), DELAY LED and KEYLOCK LED 5-segment bargraph (mod. TL46-WL)
Dark/light selection	Switch; Automatic; Automatic/manual; remote/dynamic
Delay	0...20ms selectable via delay input 0...100ms programmed
Auxiliary function	Keylock (not available on TL46-WE) Fine Hysteresis regulation (TL46-WL/WLF/WE)
Output	PNP (mod. TL46-WJ); PNP or NPN; PNP/NPN (mod. TL46-W/WL/WLF/WE by part number); PP/PNP/NPN (TL46-W/WH...PZ); analog output (mod. TL46-A/W/WL)
Output current	100mA
Saturaton Voltage	= <2V
Analogue Out	0,5...5,5V ±10%; 2V on white target 90%; 1...3V ±10%(white 90%) ; 5,5V max
Analogue out impedance	2,2 kΩ (short circuit protection)
Connection	M12 5-pole connector
Dielectric strength	500 Vac, 1 min between electronics and housing
Insulating resistance	>20 MΩ, 500 Vdc between electronics and housing
Electrical protection	class 2, double insulation
Protection device	Reverse polarity protection, overload and short circuit protection
Mechanical protection	IP67
Ambient light rejection	according to EN 60947-5-2
Vibrations	0,5 mm amplitude, 10 ... 55 Hz frequency, for every axis (EN60068-2-6)
Shock resistance	11 ms (30 G) 6 shock for every axis (EN60068-2-27)
Housing material	aluminium
Lens material	PMMA (mod. TL46-A, TL46-W), glass (mod. TL46-W-815G/WL/WLF/WJ/WE)
Operating temperature	-10 ... 55 °C
Storage temperature	-20 ... 70 °C
Weight	170 g max.

DIMENSIONS

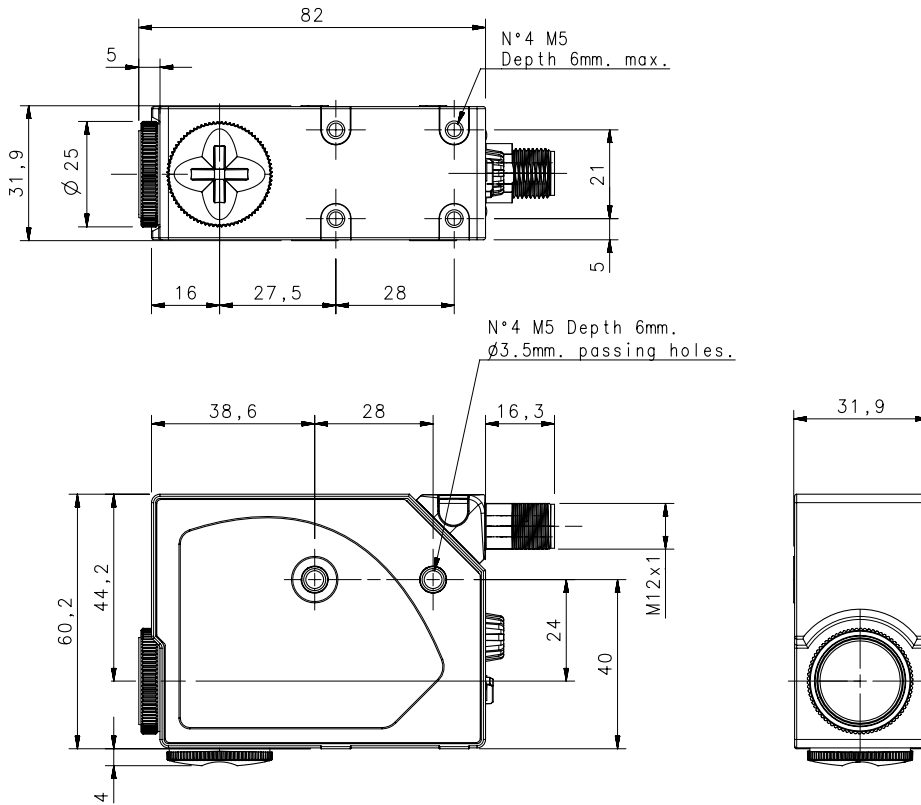

TL46-A

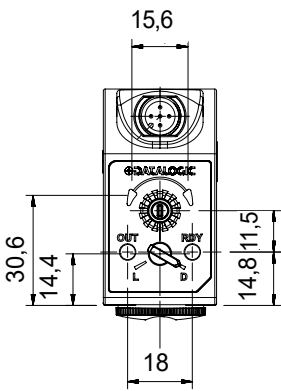

TL46-W/WJ/W...PZ

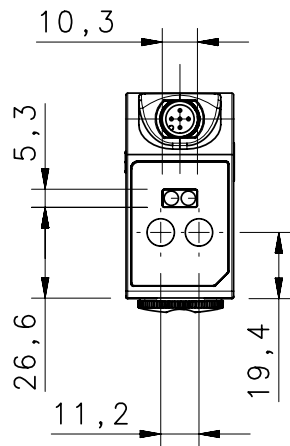

TL46-WL

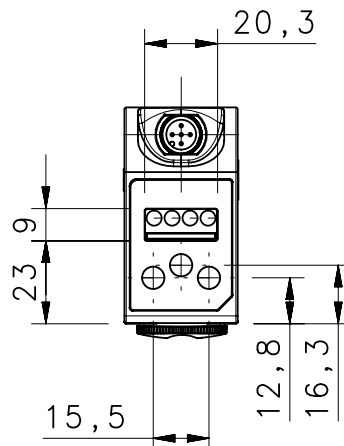

TL46-WLF/WE/WH...PZ

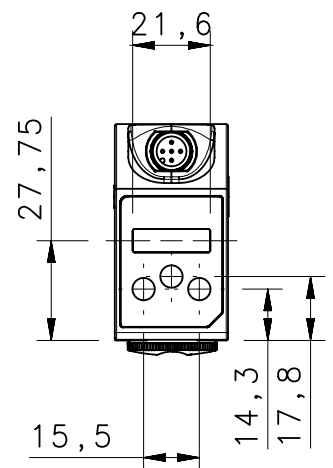

INDICATORS AND SETTINGS



**TL46-A
TRIMMER**

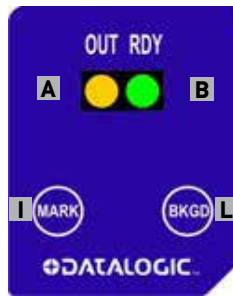

**TL46-W
BASE**

**TL46-WJ
LOW JITTER**

**TL46-W...PZ
BASE IO-Link**

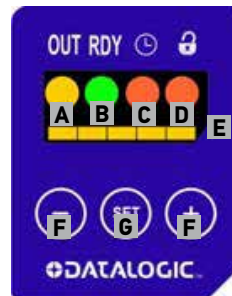

**TL46-WL
STANDARD**



**TL46-WLF
ENHANCED**

**TL46-WE
COLOR
ENHANCED**

**TL46-WH...PZ
HIGH SPEED IO-Link**

- A** yellow OUTPUT LED
- B** green READY LED
- C** orange DELAY LED
- E** orange KEYLOCK LED
- D** Bargraph
- F** +/- push-buttons
- G** SET push-button
- H** Display
- I** MARK push-button
- L** BKGD push-button
- M** Light/Dark Switch
- N** Orange Indicators Arrows
- O** Sensitivity Adjustment Knob

CONNECTIONS

TL46-A

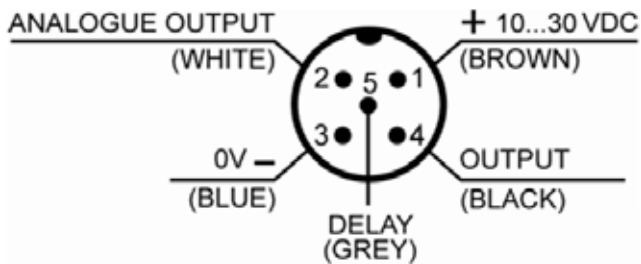

TL46-W/WL

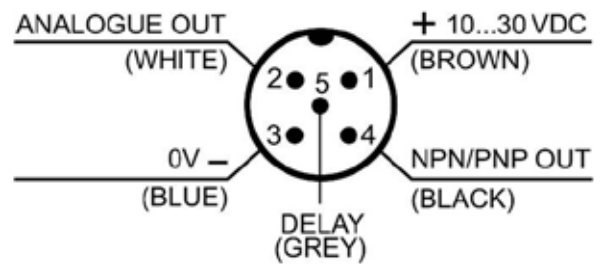

TL46-W...PZ/WH...PZ

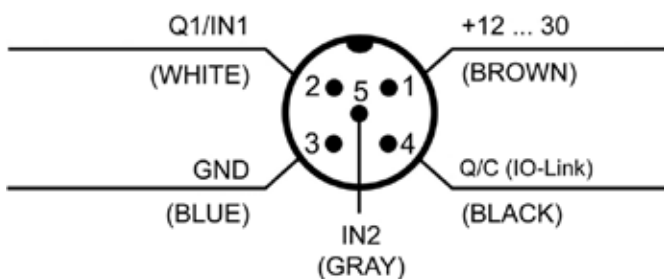

TL46-WLF/WE/WJ

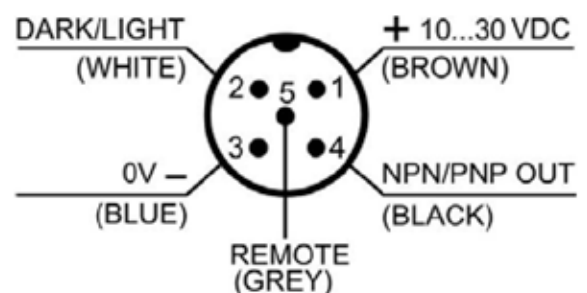

READING DIAGRAMS

FOR ALL MODELS

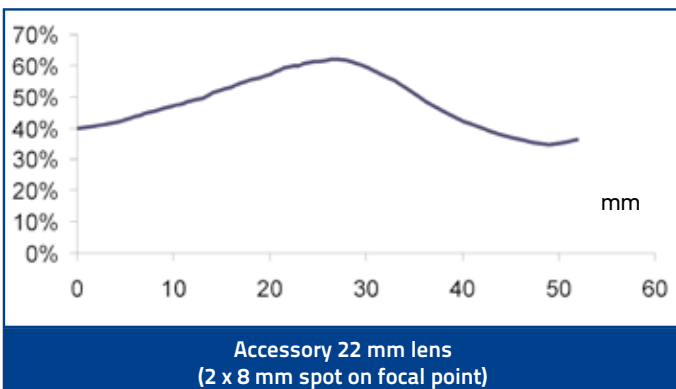
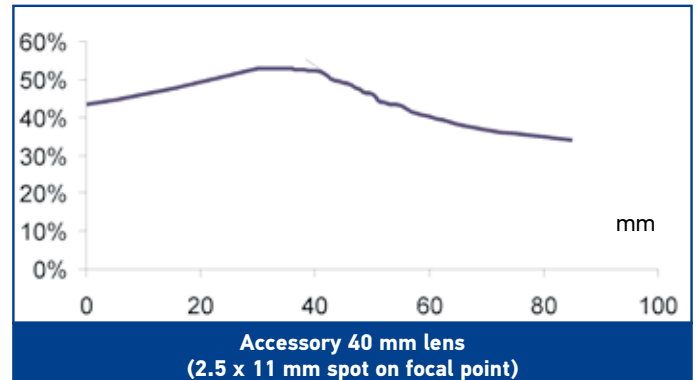
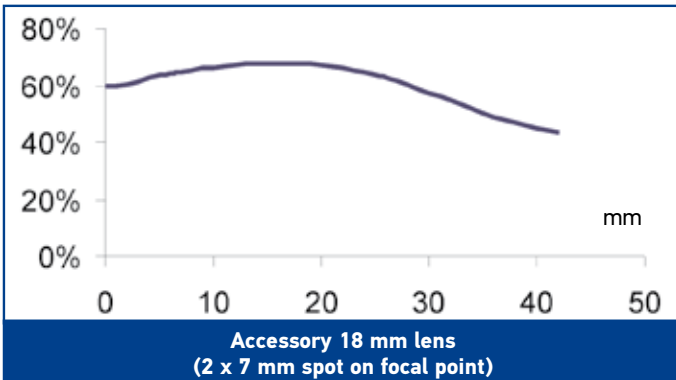
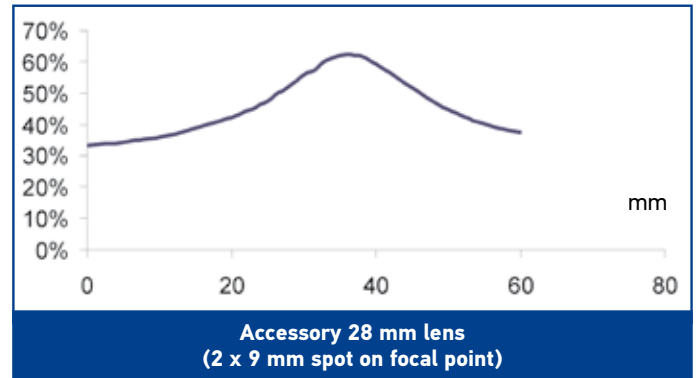
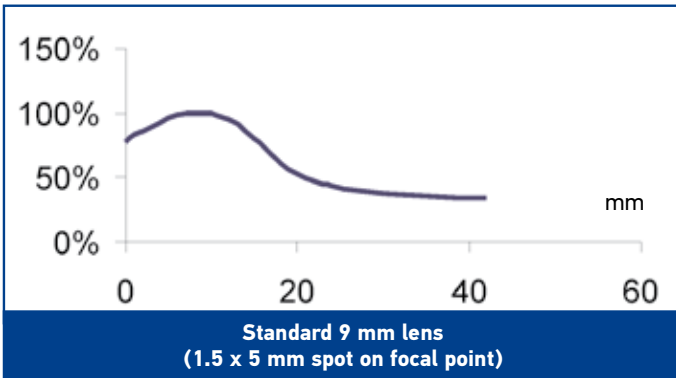

VERTICAL SPOT

HORIZONTAL SPOT



Horizontal spot is present in the TL46 models with final '-L' suffix

MODEL SELECTION AND ORDER INFORMATION

OPTIC FUNCTION	SETTING & INDICATORS	OUTPUT	EMISSION	MODEL	ORDER No.		
Contrast sensor	Trimmer 2 LEDs	PNP	WHITE vertical spot	TL46-A-415	954601070		
		NPN	WHITE vertical spot	TL46-A-425	954601080		
		PNP	RED vertical spot	TL46-A-615	954601090		
		NPN	RED vertical spot	TL46-A-625	954601100		
	Push-buttons 2 LEDs	PNP/NPN		R.G.B. vertical spot	TL46-W-815	954601000	
				R.G.B. horizontal spot	TL46-W-815L	954601010	
				R.G.B. vertical spot	TL46-W-815G*	954601060	
		IO-Link PP/PNP/NPN		R.G.B. vertical spot	TL46-W-815-PZ	954600005	
			PNP/NPN		R.G.B. vertical spot	TL46-WL-815	954601020
					R.G.B. horizontal spot	TL46-WL-815L	954601030
Push buttons 4 LEDs bargraph	PNP/NPN		R.G.B. vertical spot	TL46-WLF-815	954601040		
			R.G.B. horizontal spot	TL46-WLF-815L	954601050		
Contrast low jitter sensor	Push buttons 4 LEDs display	PNP		R.G.B. vertical spot	TL46-WJ-815	954601110	
				R.G.B. horizontal spot	TL46-WJ-815L	954601120	
Color contrast sensor	Push buttons 4 LEDs display	PNP	R.G.B. vertical spot	TL46-WE-815	954601130		
		NPN	R.G.B. vertical spot	TL46-WE-825	954601140		
High Performance Contrast sensor	Push buttons 4 LEDs display	IO-Link PP/PNP/NPN	R.G.B. vertical spot	TL46-WH-815-PZ	954600004		

(*) Glass lens version of TL46-W model

ACCESSORIES

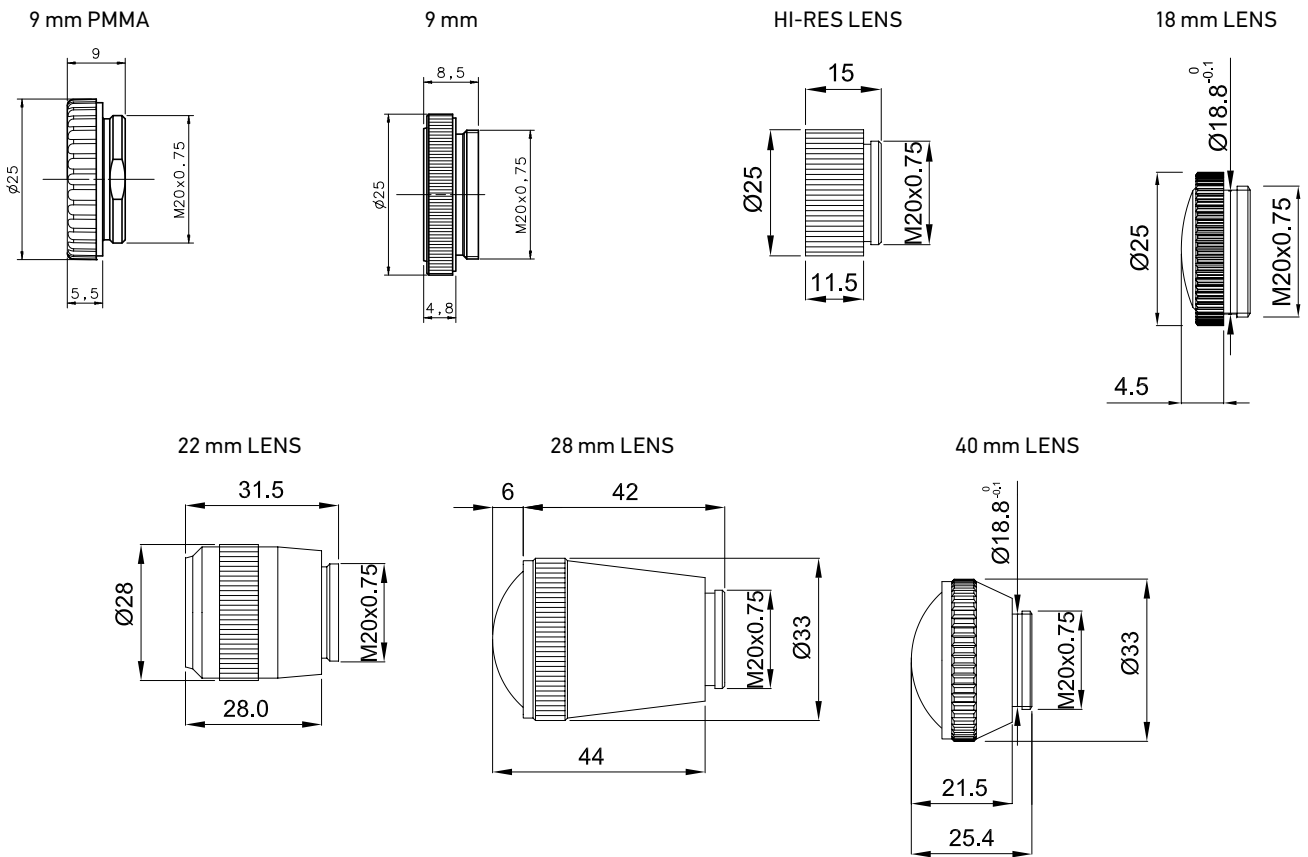

MODEL	DESCRIPTION	ORDER No.
Lens No.9	glass lens with 9 mm focus	95ACC2670
Lens No.9 PMMA	plastic lens with 9 mm focus	95ACC2540
Lens Hi-Res	additional focussing glass lens with 9 mm focus (*)	95ACC1050
Lens No.18	glass lens with 18 mm focus	95ACC2680
Lens No.22	glass lens with 22 mm focus	95ACC1100
Lens No.28	glass lens with 28 mm focus	890000194
Lens No.40	glass lens with 40 mm focus	95ACC2740

* focussing lens to screw between the sensor and the normal 9 mm lens

CABLES

TYPE	DESCRIPTION	LENGTH	MODEL	ORDER No.
Axial M12 Connector	5-pole, grey, P.V.C.	3 m	CS-A1-03-G-03	95ACC2110
		5 m	CS-A1-03-G-05	95ACC2120
		10 m	CS-A1-03-G-10	95ACC2140
	5-pole, U.L., black, P.V.C	3 m	CS-A1-03-U-03	95ASE1170
		5 m	CS-A1-03-U-05	95ASE1180
		10 m	CS-A1-03-U-10	95ASE1190
		15 m	CS-A1-03-U-15	95ASE1200
		25 m	CS-A1-03-U-25	95ASE1210
		50 m	CS-A1-03-U-50	95A252700

LD46

DATALOGIC

LUMINESCENCE SENSOR LINE IN STANDARD METAL HOUSING

- UV high power LED emission
- High sensitivity on fluorescent marks
- 10 - 50 mm detection distance
- 2 kHz switching frequency
- NPN/PNP and 0-5 V analog outputs

APPLICATIONS

- Packaging and labeling machinery
- Food, Cosmetic and Pharmaceutical
- Ceramic tiles selection and sorting



(*) ATEX II 3DG

LD46

Luminescence sensor		10...20 mm (LD46-UL-715)
		20...40 mm (LD46-UL-755)
		30...50 mm (LD46-UL-735)
Spot dimension		2x8 mm at 10 mm
		3x11 mm at 24 mm
		4x15 mm at 50 mm
Switching frequency		2 kHz
Response Time		250 µs
Light emission		UV-HP LED
Setting		push buttons
Power supply	Vdc	15...30 V
	Vac	
	Vac/dc	
Output	PNP	
	NPN	
	NPN/PNP	•
	relay	
	other	0...5 V Analog output
Connection	cable	
	connector	•
	pig-tail	
Approximate dimensions (mm)		31x81x58
Housing material		aluminium
Mechanical protection		IP67

TECHNICAL DATA

Power supply	15 ... 30 Vdc (limit values)
Ripple	2 Vpp max.
Consumption (output current excluded)	50 mA max. at 24 Vdc
Light emission	UV LED 375 nm
Setting	SET push-buttons
Indicators	yellow OUTPUT LED green READY LED orange DELAY LED and KEYLOCK LED 5-segment bargraph
Output	PNP/NPN; analog output
Output current	100 mA max.
Saturation voltage	2 V max.
Response time	250 µs
Switching frequency	2 kHz
Connection	M12 5-pole connector
Dielectric strength	500 Vac, 1 min between electronics and housing
Insulating resistance	>20 MΩ, 500 Vdc between electronics and housing
Electrical protection	class 2, double insulation
Mechanical protection	IP67
Ambient light rejection	according to EN 60947-5-2
Vibrations	0,5 mm amplitude, 10 ... 55 Hz frequency, for every axis (EN60068-2-6)
Shock resistance	11 ms (30 G) 6 shock for every axis (EN60068-2-27)
Minimum spot dimension	2 x 8 mm at 10 mm (mod. LD46-UL-715) 3x11 mm at 24 mm (mod. LD46-UL-755) 4x15 mm at 50 mm (mod. LD46-UL-735)
Housing material	aluminium
Lens material	glass
Operating temperature	-10 ... 55 °C
Storage temperature	-20 ... 70 °C
Weight	180 g max.

DIMENSIONS

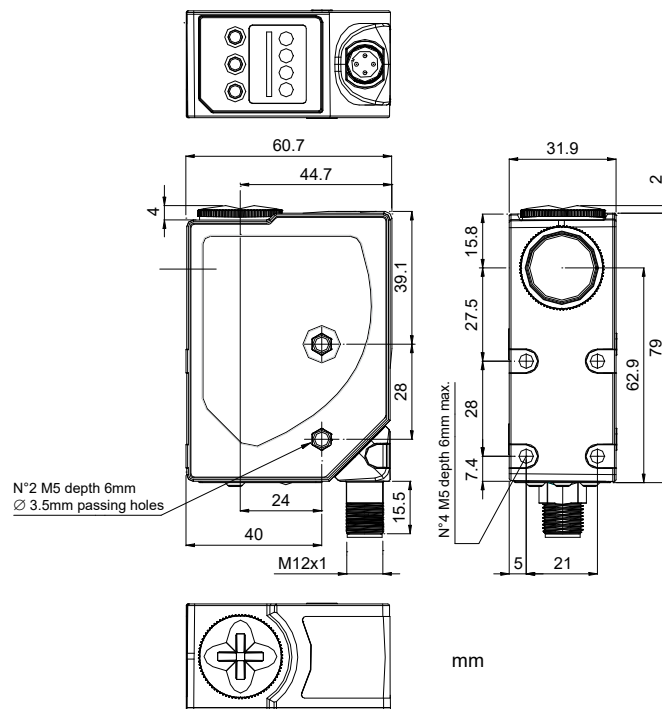

INDICATORS AND SETTINGS

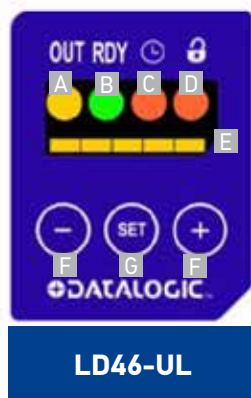

- A** yellow OUTPUT LED
- B** green READY LED
- C** orange DELAY LED
- D** orange KEYLOCK LED
- E** Bargraph
- F** +/- push-buttons
- G** SET push-button

CONNECTIONS

M12 CONNECTOR

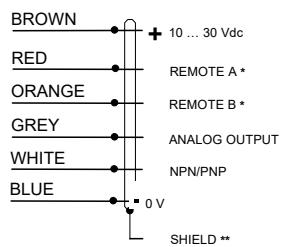

DETECTION DIAGRAMS

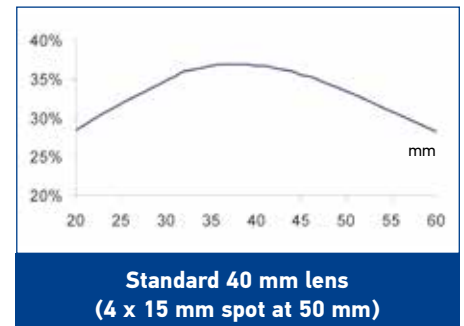
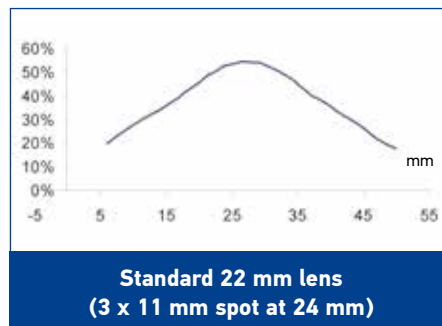
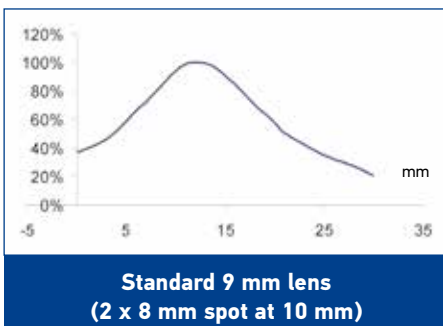

MODEL SELECTION AND ORDER INFORMATION

OPTIC FUNCTION	EMISSION	CONNECTION	OUTPUT	MODEL	ORDER No.
Luminescence sensor	10-20 mm Vertical spot	M12 Connector	NPN/PNP	LD46-UL-715	955201000
	20-40 mm Vertical spot			LD46-UL-755	955201010
	30-50 mm Vertical spot			LD46-UL-735	955201020

ACCESSORIES

50 mm LENS

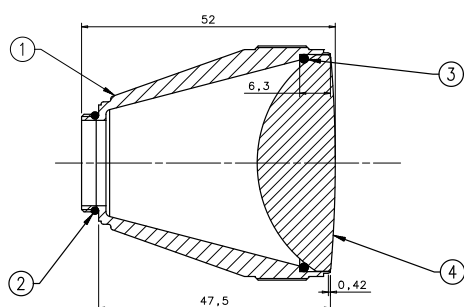

40 mm LENS
(LD46-UL-735)

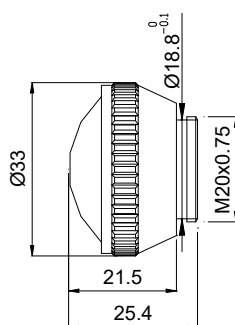

22 mm LENS
(LD46-UL-755)

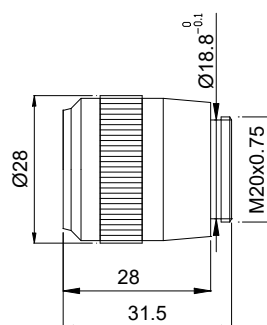

9 mm LENS
(LD46-UL-715)

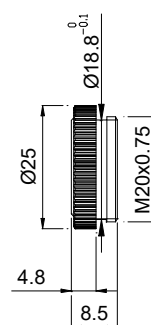

MODEL	DESCRIPTION	ORDER No.
Lens No.9	glass lens with 9 mm focus	95ACC2670
Lens No.22	glass lens with 22 mm focus	95ACC1100
Lens No.40	glass lens with 40 mm focus	95ACC2740
Lens No.50	glass lens with 50 mm focus	S73030511

CABLES

TYPE	DESCRIPTION	LENGTH	MODEL	ORDER No.
Axial M12 Connector	5-pole, grey, P.V.C.	3 m	CS-A1-03-G-03	95ACC2110
		5 m	CS-A1-03-G-05	95ACC2120
		10 m	CS-A1-03-G-10	95ACC2140
	5-pole, U.L., black, P.V.C	3 m	CS-A1-03-U-03	95ASE1170
		5 m	CS-A1-03-U-05	95ASE1180
		10 m	CS-A1-03-U-10	95ASE1190
		15 m	CS-A1-03-U-15	95ASE1200
		25 m	CS-A1-03-U-25	95ASE1210
		50 m	CS-A1-03-U-50	95A252700

Smart-VS



AI enabled

MLAS - Machine Learning Assisted Setting



THE SMART VISION SENSOR ENABLED WITH A.I. AND EMPOWERED BY MACHINE LEARNING ASSISTED SETTING ALGORITHMS. SIMPLY CLEVER SOLUTION FOR ALL YOUR PRESENCE AND ORIENTATION OBJECT DETECTION APPLICATIONS

- Machine Learning Assisted Setting
- No vision Tools programming required
- No inspection threshold adjustment
- No need of skilled installers and users
- Fast and Easy Setting like standard photosensor
- Deterministic response time 50ms
- Reduced cost of ownership and maintenance
- TEACH Button and comprehensive UI with 5 status LEDs
- Electronic focus control
- 50...150mm operating distance
- Bright and visible Red LED pointer
- Powerful white polarized light illuminator
- Green/Red LED Spot for GOOD/NO GOOD part
- Ethernet point to point communication available
- Easy and Intuitive WEB Server GUI for maintenance and job setting
- Easy output interface photosensor like

APPLICATIONS

- Processing and packaging machinery
- Transport and handling lines
- Assembly lines
- Food & Beverage
- Bottling lines
- Machines for the Cosmetic and Pharmaceutical sector

ELECTRICAL FEATURES

Power	
Supply Voltage (Vdc)	10 to 30 Vdc
Consumption (A) Max.	0.40 - 0.14 A (4.2 W)
Communication Interface	
Ethernet ¹	10/100 Mbit/s
Inputs	Opto-coupled and polarity insensitive
Max. Voltage	30 Vdc
Max. Input Current	10 mA
Output Type	Push-pull, NPN or PNP, short circuit protected
Outputs	3 Outputs (DATA VALID, GOOD, NO GOOD)
$V_{OUT} (I_{LOAD} = 0 \text{ mA}) \text{ Max.}$	30 Vdc
$V_{OUT} (I_{LOAD} = 100 \text{ mA}) \text{ Max.}$	3 Vdc
$I_{LOAD} \text{ Max.}$	100 mA

¹ The embedded Ethernet interface is intended for configuration only through connection to the device IP. Point-to-Point connection is recommended.

TECHNICAL DATA

Optical and Detection Features

Operating distance	50...150 mm
View angle	19°
FOV area @ 50 mm	22 mm (H) x 16 mm (V)
FOV area @ 150 mm	55 mm (H) x 41 mm (V)
Response Time	50 ms
Max. Image to handle (GOOD+NO GOOD)	6 images
Max pcs per second	20 pcs per second
Active Area Resolution	320x240 pixels
Illuminator	White LED polarized

Physical Features

Dimensions	H x W x L 78 x 47 x 38 mm (3.1 x 1.9 x 1.5 in) 58 x 47 x 58 mm (2.3 x 1.9 x 2.3 in)
Weight	173 g (6.1 oz)
Material	Aluminum with plastic PMMA protective window

Environmental Features

Operating Temperature²	-10 to 50 °C (14 to 122 °F)
Storage Temperature	-20 to 70 °C (-4 to 148 °F)
Max. Humidity	90% non-condensing
Vibration Resistance	14 mm @ 2 to 10 Hz; 1.5 mm @ 13 to 55 Hz; 2 g @ 70 to 500 Hz; 2 hours on each axis
Shock Resistance	30 g; 11 ms; 3 shocks on each axis
Protection Class³	IP65 and IP67

1 The embedded Ethernet interface is intended for configuration only through connection to the device IP. Point-to-Point connection is recommended.

2 High ambient temperature applications should use metal mounting bracket for heat dissipation.

3 When correctly connected (fully tightened) to IP67 cables with seals.

DIMENSIONS

Smart-VS STRAIGHT CONNECTORS

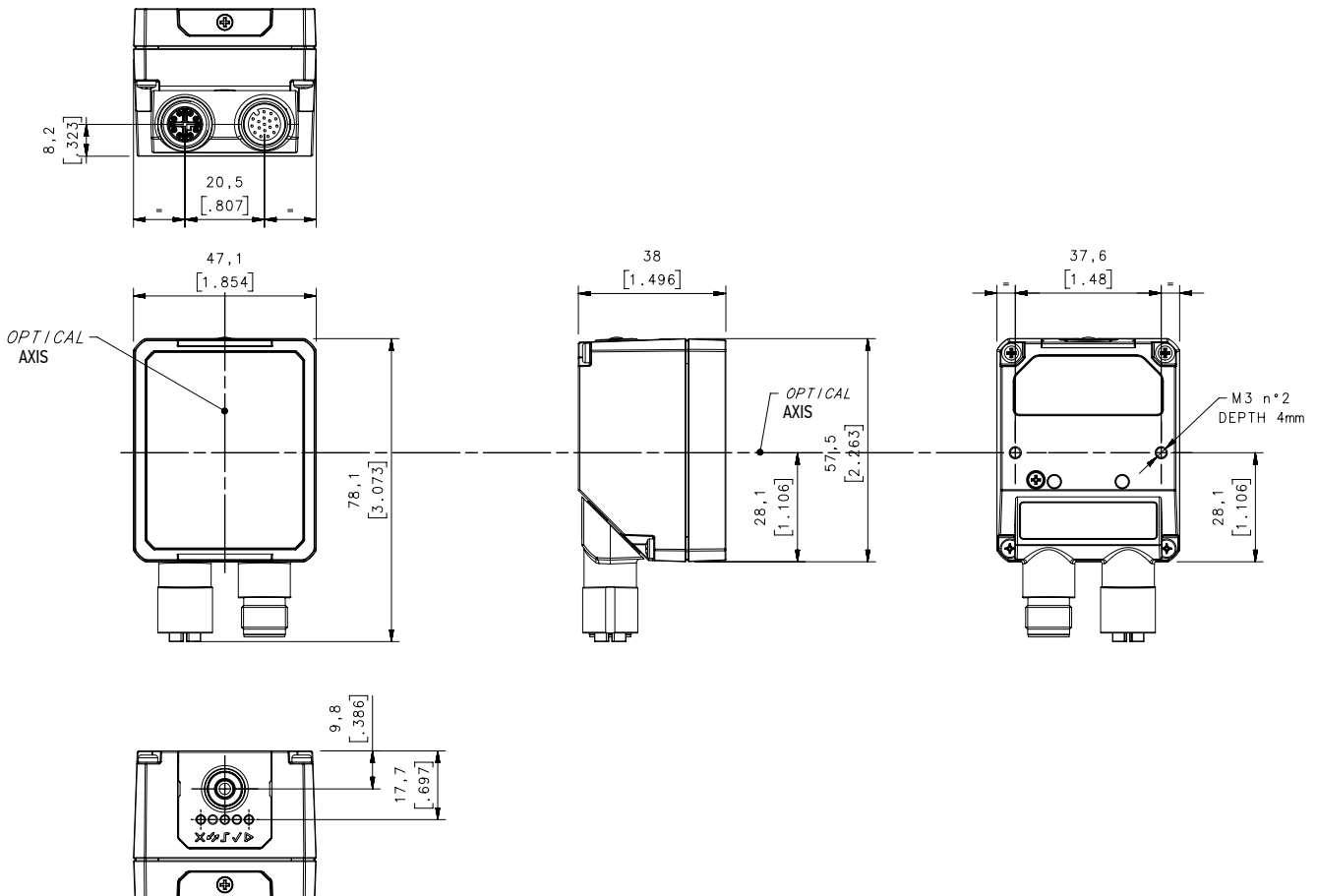

SMART-VS 90° CONNECTORS

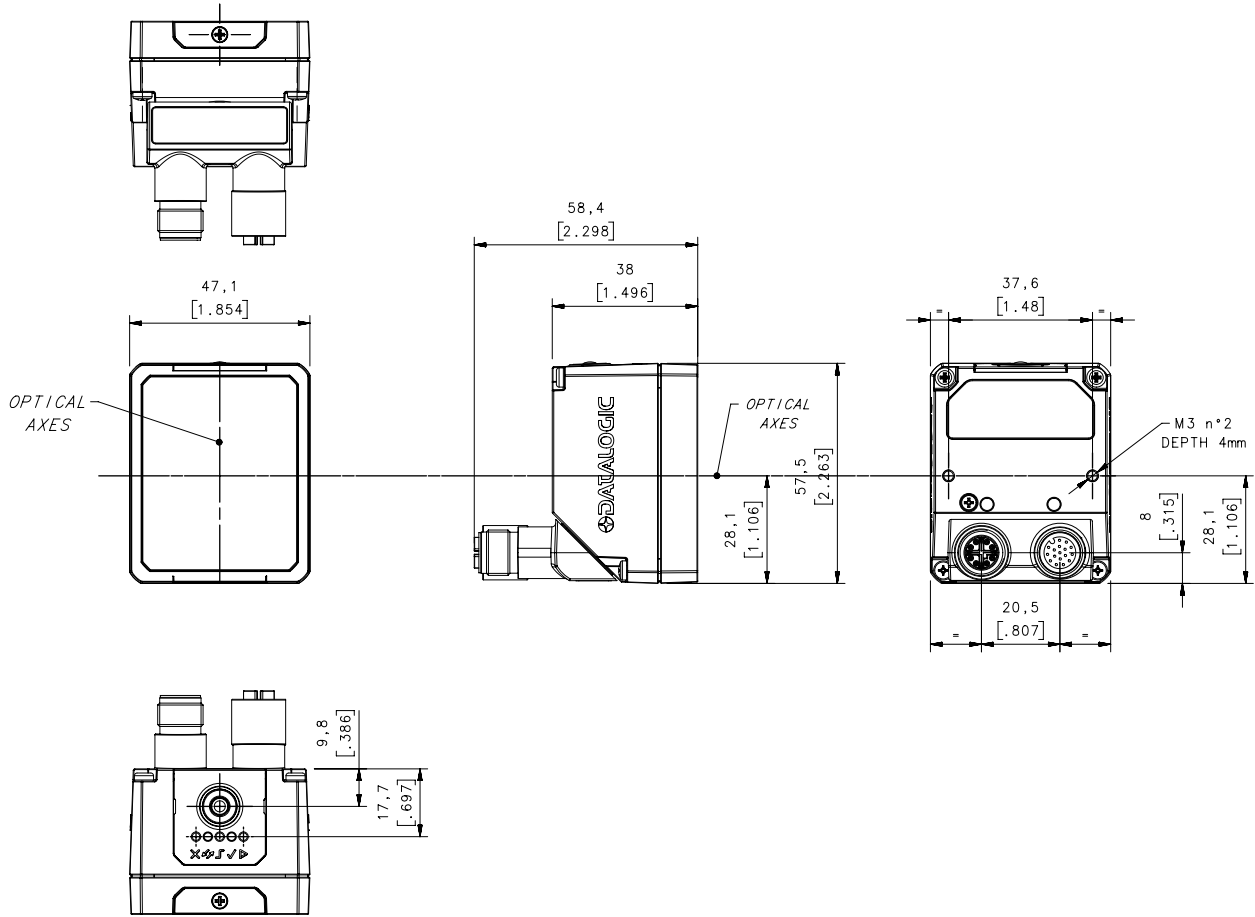

CONNECTIONS

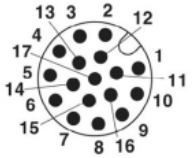

M12 17-pin Power, COM, and I/O Connector Pinout			
Pin	Name	Colore	Funzione
1	Vdc	Marrone	Power supply input voltage +
2	GND	Blu	Power supply input voltage -
Connector case	Chassis		Connector case provides electrical connection to the chassis
6	I1A	Yellow	I1A Trigger Input A (Polarity Insensitive)
5	I1B	Pink	I1B Trigger Input B (Polarity Insensitive)
13	I2A	White/Green	I2A Remote Teach A (Polarity Insensitive)
3	I2B	White	I2B Remote Teach A (Polarity Insensitive)
9	O1*	Red	Data Valid PP
8	O2*	Grey	GOOD Output PP
16	O3*	Yellow/Brown	NO-GOOD Output PP

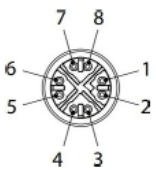

M12 8-pin Standard Ethernet Network Connector Pinout		
Pin	Name	Function
1	TX+	Transmit data (positive pin)
2	TX-	Transmit data (negative pin)
3	RX+	Receive data (positive pin)
4	RX-	Receive data (negative pin)
5	nc	Not Connected
6	nc	Not Connected
7	nc	Not Connected
8	nc	Not Connected

INDICATORS AND SETTINGS

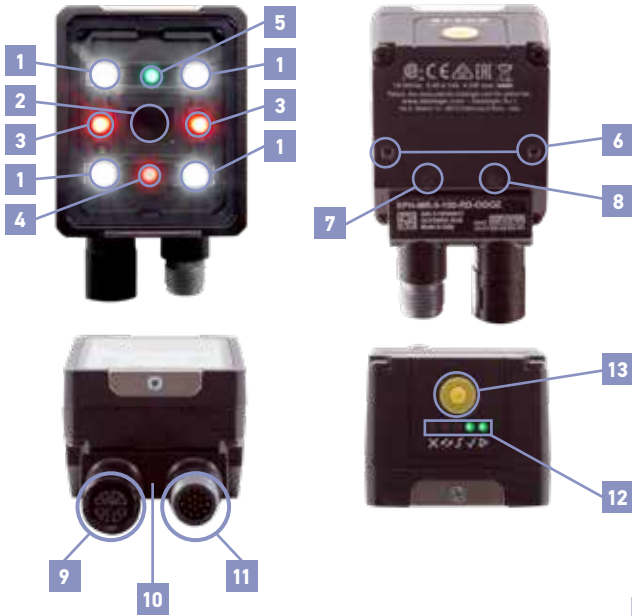

ITEM N.	DESCRIPTION
1	Illuminator with 4 powerful White LEDs with polaroid filter
2	7mm lens with automatic focus system
3	Aiming system with 2 powerful Red LEDs
4	Red Spot illuminator LED for NO GOOD detection object
5	Green Spot illuminator for GOOG detection object
6	2 holes for direct mounting or bracket
7	Blue Power Supply LED
8	Yellow Ethernet connection LED
9	M12 Ethernet X-coded female connector
10	Rotating connector block
11	M12-17 Pin Power Supply and I/O male connector
12	5 bright LED for User Interface signalization
13	Yellow TEACH-IN button for sensor set-up



HMI CONFIGURATION	
	NO GOOD object <ul style="list-style-type: none"> • blinking: NO GOOD object teaching • in Run phase: NO GOOD object detected
	For future use
	Trigger <ul style="list-style-type: none"> • trigger received
	GOOD object <ul style="list-style-type: none"> • blinking: GOOD object teaching • in Run phase: GOOD object detected
	Run <ul style="list-style-type: none"> • device in RUN phase

DETECTION DIAGRAMS

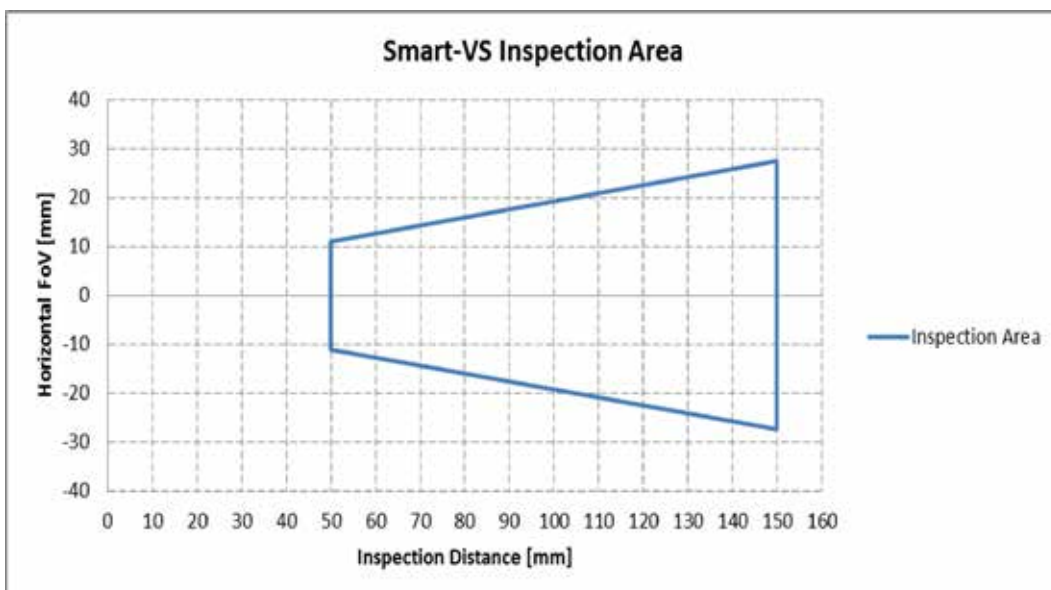

FIELD OF VIEW CALCULATION

Use the data in the following table to calculate the FOV for your application, referring to the draw and the formula below.

D_0	View angle horizontal	View angle vertical	View angle diagonal	Min Reading Distance mm
11 mm	19°	14,5°	24°	50 mm

The viewing angle has a tolerance of $\pm 1^\circ$ depending on the reading distance.

$$FOV_x = 2 [(d + d_0) * \tan (\alpha/2)]$$

where:

FOV_x = horizontal, vertical or diagonal FOV

α = horizontal, vertical or diagonal viewing angles.

d = reading distance (in mm) from window surface to code surface

d_0 = offset (in mm) from center of lens to external window surface

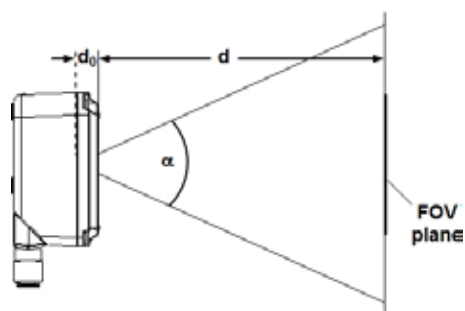

Example:

The FOV at a **reading distance of 100 mm** is:

$FOV_H = 2[(100\text{mm} + 11\text{mm}) * \tan(19^\circ/2)] \cong 37\text{mm}$

$FOV_V = 2[(100\text{mm} + 11\text{mm}) * \tan(14,5^\circ/2)] \cong 28\text{mm}$

OPERATING PRINCIPLES AND APPLICATIONS

Smart-VS simply clever

The Smart-VS is a Smart vision sensor simple and clever. It is simple outside since it can be handled and used like a standard photoelectric sensor but powerful and smart inside with a multiprocessor platform supporting and embedding the Artificial Intelligence technology. Its customized machine learning algorithms are empowering the detection system core enabling very complex and accurate object classification ensuring at same time a very simple setting procedure by the user

The user does not have to take care about programming or setting threshold of different vision tools, all these complex functionalities are operated by the Smart-VS "brain".

The detection function will be accomplished with three easy and fast steps. The quick step is the GOOD condition teaching the second step is no good condition teaching the third will turn the sensor in learning and normal run status ready to detect GOOD or NO GOOD objects. The user will just present the objects in front of sensor eye and push the button to change acquisition steps until the sensor will start to think and act.













The sensor is especially suited for all the applications where it is needed to solve detection between two well specified object condition classes, like presence or absence of a specific feature or object orientation respect two sides, teaching the sensor with GOOD and NO GOOD condition.

The Smart-VS principle of working is to teach the sensor with GOOD and NO GOOD object condition, this is the basic rule for any application.

This is the reason why it can be used in an effective and reliable way for the presence/absence of object features for side orientation of objects referring to proper object attributes.

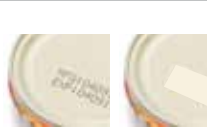
This working principle makes the sensor setting easy and independent by the type, material, color of the object that needs to be detected.

Application name		Solved cases (OK / NOT OK)	
Check label presence			
Cap orientation			
Cap presence			
Check printing on label			

The main application targeted for the best use of the Smart-VS is mainly related to print and apply application where it is needed to detect presence or absence of Labels or text printing.

Liquid filler machineries where it is needed to detect the presence/absence of any kind of cap on any kind of bottles, vials, flasks, phials of any material, does not matter if made of glass, plastic or with bright dark color shiny surfaces and different dimensions. Just make the sensor teach and learn the GOOD/NO GOOD condition and it will work. You do not need to set vision tools, sensitivity thresholds, image exposition, focus, sensor positioning or sensor sensitivity.

Bottling machines where it is needed to check if the label is present or not on the object making the sensor learning the presence/absence and then make it work immediately without additional settings, just pressing a push button or building up different receipts for different formats with an effective and easy WEB GUI interface.

Application name

Check label presence	
Cap orientation	
Cap presence	
Check printing on label	

A great value for all the applications

The Smart-VS redefines the standard detection eliminating all the concerns regarding the use of standard sensors about unstable detection or complex installation layouts to perform the presence/absence or orientation applications, a Smart-VS based system will ensure:

- more stability in terms of different object materials and shape
- excellent stability on glass and metal parts
- more simple system installation
- more flexibility and adaptability about different production format
- easy setting avoiding more expensive and complex devices
- lower cost of ownership and maintenance



SMART-VS SETTING METHODS

Easy and Comprehensive system integration

The Smart-VS is very easy and simple to integrate in any application, it can be implemented like a sensor product, but it is much simpler than a smart camera or an ordinary smart sensor.

It is needed to provide a trigger signal by machine electrical phase or an external simple sensor or an encoder. The PC or Ethernet based terminal is an option needed to change configuration of the sensor (once a time) or for more complex set-up where it is needed to change and/or add job setting through the web interface with a browser, in most cases the need to have this connection is not necessary. The web interface can be a useful tool in case of trouble shooting

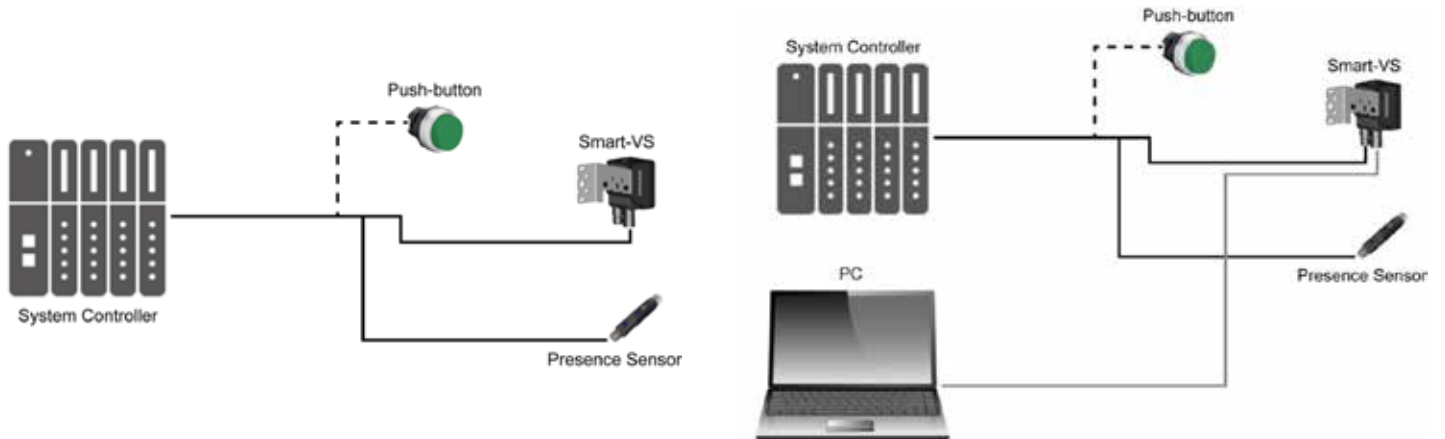

WEB INTERFACE

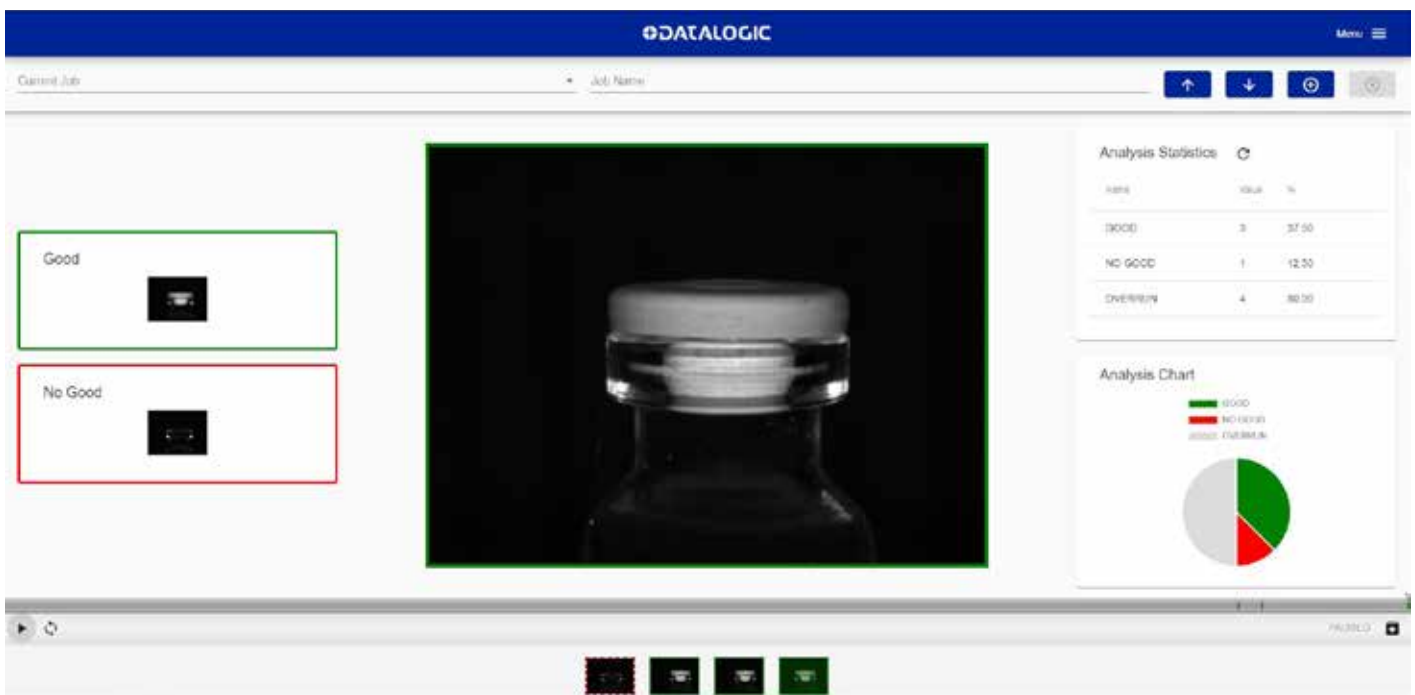

The Smart-VS is provided of a WEB Server User interface for an easy set-up and setting. This is a good option feature when it is needed to setup and change different production jobs depending on variable production format. The information are complete and shown in a clear layout.

MODEL SELECTION AND ORDER INFORMATION

MODEL	DESCRIPTION	OPTIC	ILLUMINATOR	I/O	ORDER N°
Smart-VS-MR-5-150-WH-0	SVS WP 150mm OUT	7mm	White polarized	3Out + 2In + ETH	959971320

ACCESSORIES

CATEGORY	PART NUMBER	DESCRIPTION
Cables	93A050076	CAB-GD03 M12 F/L 3M Free wires
	93A050077	CAB-GD05 M12 F/L 5M Free wires
	93A050122	M12-IP67 GIGA Ethernet Cable X-Coded (1M)
	93A050123	M12-IP67 GIGA Ethernet Cable X-Coded (3M)
	93A050124	M12-IP67 GIGA Ethernet Cable X-Coded (5M)
	93A050128	Adapter Cable GIGA Ethernet X-Coded M12 to RJ45
	93A050129	Adapter Cable GIGA Ethernet X-Coded M12 to D-Coded
Bracket	93ACC0230	BK-22-000 Fixing Bracket M220 Body

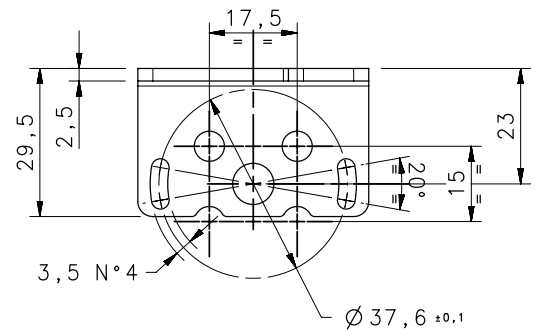
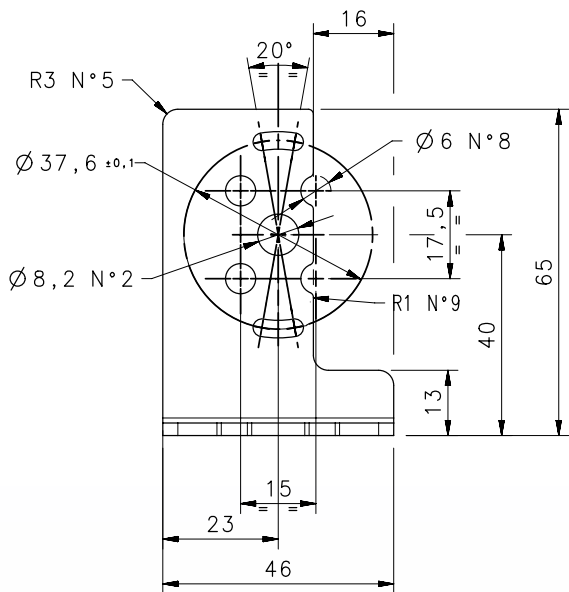

BK-22-000 Fixing Bracket

IO-Link Master

DATALOGIC

CBX-8IOL-XXXX

- Eight M12 IO-Link ports to PROFINET or Ethernet IP, which allows up to eight sensor or actuator connections on a single master
- L-Coded power connectors
- Rugged IP67 housing design for harsh environments
- Dual Ethernet ports
- Additional digital input on every port
- Power port sharing capability
- PLC access to IO-Link ISDU blocks without complex programming
- Supports the IOL_CALL function
- OPC-UA based technology
- Web server User Interface
- Download/Upload and handling of IODD files directly on Master unit

APPLICATIONS

- Processing and Packaging machinery
- Conveyor lines, material handling
- Ceramics intralogistics
- Automated warehousing
- Industry 4.0 based applications



GENERAL VIEW

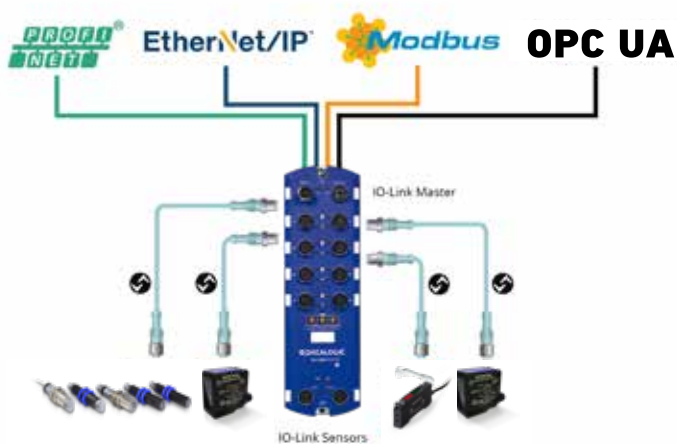

CBX-8IOL Master

The IO-Link Master is a very versatile industrial standard device. It provides the best solution about IO-Link gateway systems the embedded OPC-UA based technology.

This new device series combines all the IO-Link standard technology benefits with OPC-UA and Field buses like Ethernet-IP, Profinet and Modbus all together in one family with two different devices to select the appropriate bus technology.

The IO-Link Master is able to run simultaneously different technologies allowing the use of OPC-UA without the need of a PLC included in the system saving hardware and software cost. The IO-link data can be sent by an IO-Link sensor directly up to any SCADA or HMI software system.

The unique and integrated WEB server Technology allows to get connected with your sensor bank just with a ethernet based device and using any commercial internet browser, setting and reading sensor parameters in the most efficient and easy way.

TECHNICAL DATA

SPECIFICATION	PROFINET	EIP
Hardware		
Network Interface	10/100BASE-TX	
Enclosure	Molded Polyamide 66 (potted)	
Ingress Protection Rating	IP67	
Installation and Grounding Method	Machine or panel mount Two-hole M4 or #8	
Network Protocols	PROFINET IO, Modbus/TCP (slave)	EtherNet/IP™, Modbus/TCP (slave)
Channels	8 x IO-Link / Digital I/O (configurable)	
	8 x Digital Input DI	
	2 x Ethernet	
LED Indicators	Power, Module Status, Network Status, IO-Link, DI and Ethernet Port Status	
Dimensions	212 x 65 x 30 mm (8.35 x 2.56 x 1.18)	
Product Weight	454g (1.0 lb)	
Electrical Specifications		
Power Connectors	1 x Power Input	
	1 x Power Output	
Connector type	M12, L-coded, 4 + FE	
Power Connector Pin-Out	Pin 1 – US+ (Master electronics & sensor supply)	
	Pin 2 – UA- (Actuator supply)	
	Pin 3 – US- (Master electronics & sensor supply)	
	Pin 4 – UA- (Actuator supply)	
	Pin 5 – FE	
DC Input Voltage Range	20 VDC – 30 VDC	
Power Supply In		
Module electronics and sensor (Us)	16A (max.)	
Actuator supply (UA)	16A (max.)	
Power Consumption (module electronics)	120mA @ 24VDC	
Power Supply Out		
US	16A (max.) *	
UA	16A (max.) **	
* US output available is determined by subtracting the following from the available input current:	Module electronics Total C/Q current for all IO-Link ports Total sensor supply current	
** UA output available is the same as the available	UA input current	
Environmental Specifications		
Operating Temperature	-25°C to +60°C	
Storage Temperature	-40°C to +70°C	
Operating Humidity (Non-Condensing)	10% to 95%	
Storage Humidity (Non-Condensing)	10% to 95%	
Ingress Protection	IP67 (EN / IEC 60529)	
Shock / Vibrations	EN60068-2-6	
	EN60068-2-27	
Environmental / Mechanical Approvals	IEC 61131-2	
Ethernet Interface Ports		
Number of Ports	2	
Connector Type	M12 D-coded, 4-pin	
Ethernet Specification	10/100BASE-TX	
Standards	IEEE 802.3: 10BASE-T	
	IEEE 802.3u: 100BASE-TX	
Auto-MD/MDI-X	Yes	
Auto-Negotiation	Yes	
Link Distance	100 m	
Cable Types	---	Unshielded or Shielded twisted pair (Cat 5 or higher)
IPv4 Addressing	---	Yes
IO-Link Ports Specifications		
IO-Link Version	Supports V1.0 and V1.1	
Connectors	8 (PORT 1 – 8)	
Connector type	M12, A-coded Female, 5-position	
Channels	8 x IO-Link / Digital I/O (configurable)	
	8 x DI	

Port Pinout	Pin 1 = L+	
	Pin 2 = DI	
	Pin 3 = L-	
	Pin 4 = C/Q	
	Pin 5 = no connect	
SPECIFICATION	PROFINET	EIP
IO-Link Ports Specifications		
Configurations per Port		
Pin 4 (configurable):	DI (SIO mode)	
	DO (SIO mode)	
Pin 3	DI	
Output Current L+/L- (sensor)	1.6 A (Port 1)	
	1.0 A (Port 3)	
Output Current C/Q	500 mA (Port 2, 4 – 8; each)	
Output Current per Master (C/Q & L+/L-)	200 mA	
IO-Link Mode Transfer Rates	6.7 A (max.)	
	4.8K (COM1)	
	38.4K (COM2)	
Baud Rate Recognition	230.4K (COM3)	
Cable Length	Automatic	
Protection	20 m (max.)	
Cable Length (Maximum)	Overload and short circuit protection (Self recovers)	
IO-Link Ports – Digital Input SIO Mode (Port Pin 4)		
Input Characteristics	IEC 61131-2 Type 1 and Type 3 Compliant	
Input Threshold	High: 10.5 – 13.0V	
	Low: 8.0 – 11.5V	
Typical Input Current	3 mA	
Cable length (max.)	30 m	
IO-Link Ports – Digital Output SIO Mode (Port Pin 4)		
Typical Output Voltage	24 VDC	
Output Current (max.)	200 mA	
Output Current per Master	1.6 A (max.)	
Lamp Load (max.)	4W	
Protection	Overload and short circuit protection	
Output Function	PNP/NPN (Push-Pull)	
Cable length (maximum)	30 m	
IO-Link Ports – Digital Input (Port Pin 3; dedicated)		
Input Characteristics	IEC 61131-2 Type 1 and Type 3 Compliant	
Typical Input Current	3 mA	
Input Threshold	High: 6.8 – 8.0V	
	Low: 5.2 – 6.4V	
Reverse Polarity Protected	Yes (-40V to +40V)	
Cable length (maximum)	30 m	
PROFINET IO Specifications		
Web Page Configuration	PROFINET IO Device Name	---
	IOL_CALL Function Block Timeout (1-20)	---
Diagnostics	Yes	---
GSD Files	Yes	---
Diagnostics	Yes	---
EtherNet/IP Interface Specifications		
Supported PLCs		
Including but not limited to:	Control Logix	---
	Compact Logix	---
	RSLogix	---
	SLC 500	---
	PLC5	---
	MicroLogix	---
Other Class 1 or Class 3 EtherNet/IP PLCs may be supported		
ISDU Read & Writes	---	Up to 40 individual commands in one EtherNet/IP message
	---	Selectable byte swapping (none, 16-bit, or 32-bit)
ISDU Commands	---	Selectable payload sizes (4 to 232 bytes)
	---	ISDU block index
	---	ISDU sub-index
	---	Length of read or write
	---	Data payload

	Port configuration for ISDU Data, Process Data, Transfer Mode, Read/Write, Write PDI to Tag/File, Read PDO from Tag/File.
Web Page Configuration	---

Diagnostics	Yes
Electronic Data Sheet (EDS)	Yes
Sample PLC Programs	Yes
SPECIFICATION	PROFINET
	EIP
	Modbus TCP
Supported Controllers (Modbus TCP Masters)	PLC
	HMI
	SCADA
	OPC Server
Supported Clients	Any Modbus TCP Client
	Applications on phones/tables
Web Page Configuration	Port configuration for ISDU Response Timeout, Process Data, and Transfer Mode.
Diagnostics	Yes
	IO-Link Master Features
Configuration	Embedded web interface, IO-Link, EtherNet/IP, and Modbus TCP
Data Storage	Automatic or Manual - Upload and/or Download
Device Validation	Yes
Data Validation	Yes
Diagnostics	IO-Link, EtherNet/IP, and Modbus TCP
Powerful Web Interface	Provides the following capabilities:
	Password protected with Admin, Operator, and User accounts
	ISDU batch handling
	Load IODD files to configure the IO-Link device
	IODD Handler parses xml files making them readable and configurable
Remote Parameterization	Log files
	Yes
	Export Information
Packaged Shipping Weight	1.2 lb, 544.3 g
Package Dimensions (L x W x H)	10.5 x 4.5 x 1.5 ; 267 x 114 x 38mm
UPC Code	7-56727-99609-5
Country of Origin	USA
ECCN	5A992
Schedule B Number	8517.62.0050
	Regulatory Approvals
Immunity	European Standard EN 61000-6-2
	International Standard IEC 61000-6-2
EN/IEC 61131-2 and EN/IEC 61131-9	IEC 1000-4-2/EN 61000-4-2: Electrostatic Discharge (ESD)
	IEC 1000-4-3/EN 61000-4-3: Radiated, Radio-Frequency (RF)
	IEC 1000-4-4/EN 61000-4-4: Fast Transient/Burst
	IEC 1000-4-5/EN 61000-4-5: Surge
	IEC 1000-4-6/EN 61000-4-6: Conducted disturbance
	IEC 1000-4-8/EN 61000-4-8: Magnetic field
	IEC 1000-4-11/EN 61000-4-11: Dips and Voltage Variations
Emission	European Standard EN 61000-6-4
	International Standard IEC 61000-6-4
	AS/NZS CISPR-11
FCC Part15 Subpart B	Class A limit
	Canadian EMC requirements ICES-001
Safety	CSA C22.2 No. 61010-1-12 / CSA C22.2 No. 61010-1-201
	UL 61010-1 / UL 61010-1-201
	UL File # E360395
Vibration	EN 60068-2-6/ IEC 60068-2-6
Mechanical Shock	EN 60068-2-27/ IEC 60068-2-27
Environmental / Mechanical Test Approvals	IEC 61131-2
Other	The components of this product comply with the requirements of the EMC/EMI Directive 2014/30/EU, Directive 2011/65/EU on the Restriction of the use of certain Hazardous Substances (RoHS2).
Regulatory Approval Symbols	

DIMENSIONS

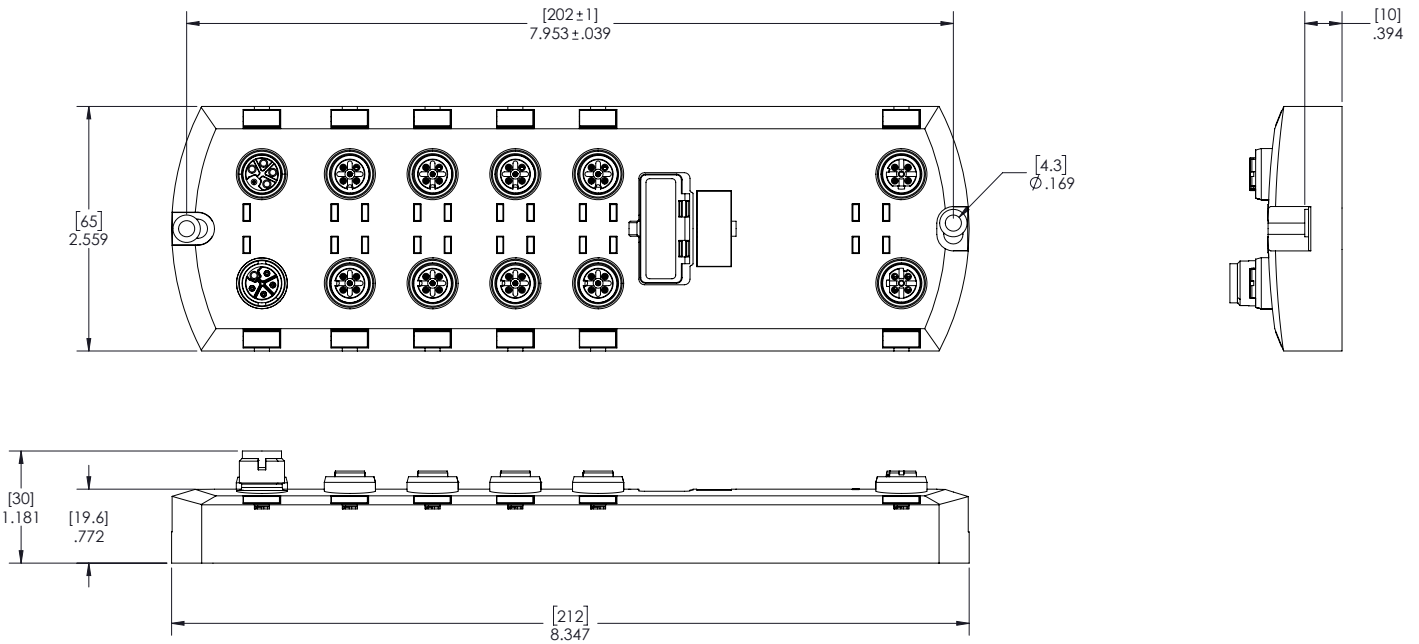

mm

CONNECTIONS

CONNECTING THE POWER

The CBX-IOL-8-PNIO provides M12 (5-poles) L-coded input and output power connectors. Use a 24VDC power supply capable of the total output current required.

Note: Power connectors must have an approved cable or protective cover attached to the port for IP67 compliance.

PIN	POWER INPUT (MALE)	POWER OUTPUT OR ACTUATOR POWER (FEMALE)	DESCRIPTION
1	US+	US+ or +V	IO-Link Master's system electronics and IO-Link devices
2	UA-	UA- or 0V	Actuator supply
3	US-	US- or 0V	IO-Link Master's system electronics and IO-Link devices
4	UA+	UA+ or +V	Actuator supply
5		FE	

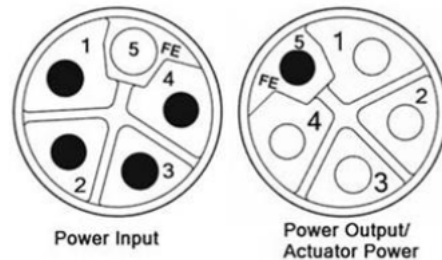

CONNECTING THE NETWORK

The IOLM provides two Fast Ethernet (10/100BASE-TX) M12, 4-pin female D-coded connectors.

PIN	SIGNAL
1	Tx+
2	Rx+
3	Tx-
4	Tx-

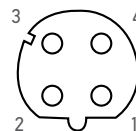

You can use this procedure to connect the IOLM to the network.

- Securely connect one end of a shielded twisted-pair (Cat 5 or higher) M12 Ethernet cable to either Ethernet port.
- Connect the other end of the cable to the network.
- Optionally, use the other Ethernet port to daisy-chain to another Ethernet device.
- If you did not connect both Ethernet ports, make sure that the unused port is covered with a connector cap to keep dust and liquids from getting in the connector.

Note: Ethernet ports must have an approved cable or protective cover attached to the connector to guarantee IP67 integrity.

INDICATORS AND SETTINGS

SETTINGS



Follow these steps to change the default rotary switch settings:

1. Gently open the window using a small flathead screwdriver.
2. Gently swing open the switch window from the top to the bottom, allowing it to pivot on the hinge on the bottom of the window.
3. Turn each dial to the appropriate position using a small flathead screwdriver.
The default setting is 000 as shown above. The arrow points to the switch location. 0 is located at the 9:00 position. Turn the dial clockwise to the appropriate setting.
4. Close the window and make sure that it snaps shut tightly.
Failure to close the configuration window properly may compromise IP67 integrity.

INDICATORS

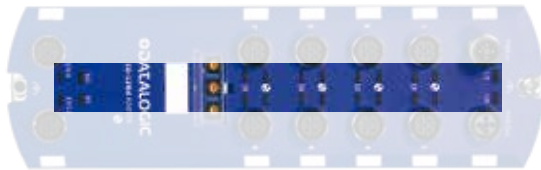

CBX-IOL-8-xxx LEDs

The CBX-IOL-8-EIP (8-port IP67 model with an L-coded power connector) provides these LEDs.

LED Activity During Power On Sequence - CBX-IOL-8-xxx LEDs

1. The **US** LED lights.
2. The **ETH1/ETH2** LED lights on the connected port.
3. The **MOD** and **NET** LEDs are lit.
4. The IO-Link LEDs flash (if no IO-Link device attached) or are lit if an IO-Link device is attached.
The **MOD** LED is solid green, the IO-Link Master is ready for operation.

CBX-IOL-8-EIP LEDs	
US	<p>The US LED provides the following information:</p> <ul style="list-style-type: none"> ▪ Green solid = The IO-Link Master is powered ▪ Red solid = Power input voltage below 18VDC
UA	<p>The UA LED provides the following information:</p> <ul style="list-style-type: none"> ▪ Green solid = The IO-Link Master is powered ▪ Red solid = Power input voltage below 18VDC
MOD (Module Status)	<p>The MOD LED provides the following information:</p> <ul style="list-style-type: none"> ▪ Off = No module status ▪ Green and red flashing = Self-test ▪ Green flashing = Standby – not configured ▪ Green solid = Operational ▪ Red flashing = Minor recoverable fault - check the EtherNet/IP Diagnostics page to locate the issue ▪ Red solid = Major unrecoverable fault
NET (Network)	<p>The NET LED provides the following information:</p> <ul style="list-style-type: none"> ▪ Off = No IP address ▪ Green and red flashing = Self-test ▪ Green flashing = An IP address is configured, but no CIP connections are established, and an Exclusive Owner connection has not timed out ▪ Green solid = Active EtherNet/IP or Modbus connection and no EtherNet/IP connection time-outs ▪ Red flashing = One or more EtherNet/IP connection time-outs ▪ Red solid = Duplicate IP address on network
 1-8	<p>This LED provides the following information about the IO-Link port</p> <ul style="list-style-type: none"> ▪ Off = SIO mode - signal is low or disabled ▪ Yellow = SIO mode - signal is high ▪ Red flashing = Hardware fault - make sure that configured IO-Link settings on the port do not conflict with the device that is attached: <ul style="list-style-type: none"> - Automatic Upload and/or Download is enabled and it is not the same device - Device Validation Mode is enabled and it is not the correct device - Data Validation Mode is enabled but there is an error ▪ Red solid = PDI of the attached IO-Link device is invalid ▪ Green solid = An IO-Link device is connected and communicating ▪ Green flashing = Searching for IO-Link devices
Port 1-4 DI	<p>The DI LED indicates digital input on DI (Pin 2)</p> <ul style="list-style-type: none"> ▪ Off = DI signal is low or disconnected ▪ Yellow = DI signal is high
ETH1/ETH2	<p>The ETH1/ETH2 LEDs provide the following information:</p> <ul style="list-style-type: none"> ▪ Green solid = Link ▪ Green flashing = Activity

IO-LINK SETTING AND CONNECTIONS

The CBX-IOL-8-EIP provides eight IO-Link ports with M12, 5-pin female/A coded connectors. Each port has robust over-current protection and short circuit protection on its L+/L- power output and C/Q IO-Link signal. The pin-out for each IO-Link port is per the IO-Link standard and is provided in the following table:

This table provides signal information for the IO-Link connectors.

PIN	SIGNAL	COLOR	DESCRIPTION
1	L+		IO-Link device power supply (+24V)
2	DI		Digital input
3	L-		IO-Link device power supply (0V)
4	C/Q		Communication signal, which supports SDCI (IO- Link) or SIO (standard input/output) digital I/O
5	FE		Functional Earth (electronics wiring)

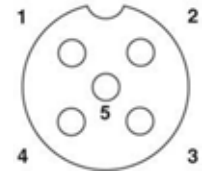

The standard SDCI (IO-Link) transmission rates are supported:

- COM1 at 4.8Kbps
- COM2 at 38.4Kbps
- COM3 at 230.4Kbps

There are active over-current limiter electronics for each port in the CBX-IOL-8-EIP that detects the overload/short-circuit condition within a few milliseconds and shuts off the output power to protect the port and the devices connected to it. The port’s power output self-recovers and restores to normal immediately after the overload or short-circuit condition is removed.

When a port is affected by overload/short-circuit condition, it does not affect the operation of the other ports. All other ports will continue to operate normally without any glitch or interruption. The current output capacity, cutoff current, and power sharing/budgeting for L+/L- and C/Q signal for the ports on the CBX-IOL-8-EIP are as follows.

WEB SERVER GUI



1 • Home



2 • IO-Link Settings

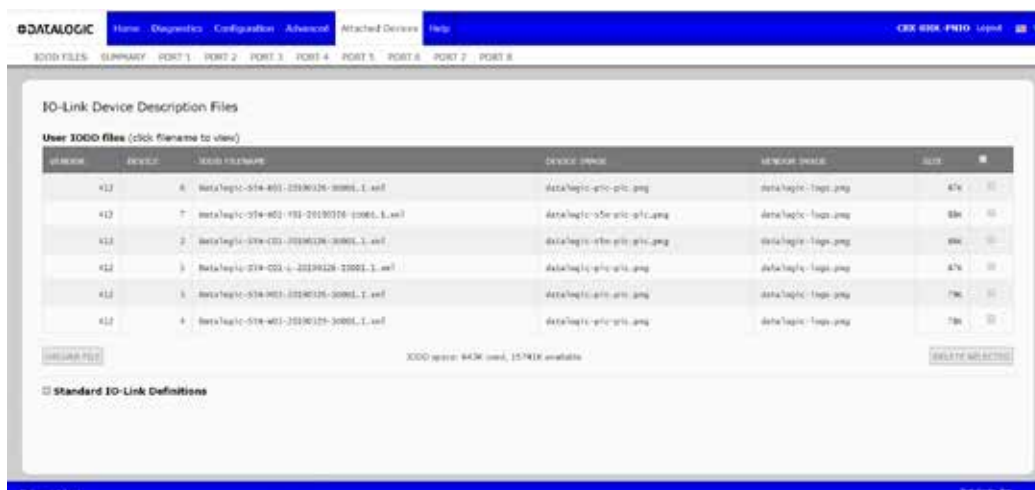

3 • IO-Link Device Description Files



4 • IO-Link Device - Port 1

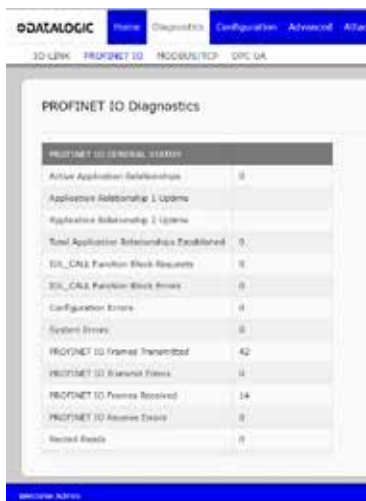

5 • PROFINET IO Diagnostics

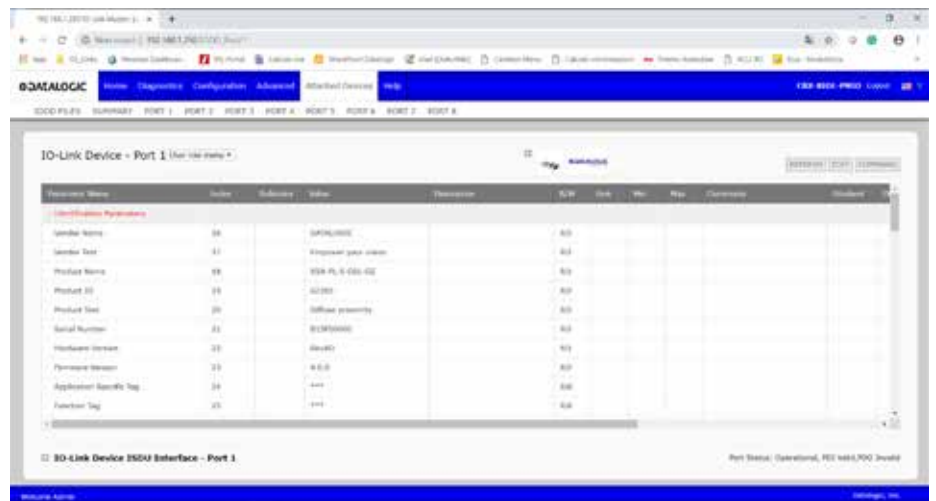

MODEL SELECTION AND ORDER INFORMATION

MODEL	DESCRIPTION	ORDER No.
CBX-8IOL-EIP	CBX-8IOL-EIP 8P IOL M12 ETHERNET IP MASTER	95ACC8180
CBX-8IOL-PNIO	CBX-8IOL-PNIO 8P IOL M12 PROFINET MASTER	95ACC8190

CABLES

TYPE	DESCRIPTION	STYLES	LENGTH	MODEL	ORDER No.
M12 L-coded Axial	5-poles	PVC Grey	3m	CS-M1-02-B-03	95ACC0007
M12 Male/M8 Female double headed axial	4-poles	PVC Black	3m	CS-H1-02-B-03	95ACC0008
M12 Male/M12 Female double headed axial	4-poles	PVC Black	3m	CS-I1-02-B-03	95ACC0009

R-SERIES REFLECTORS

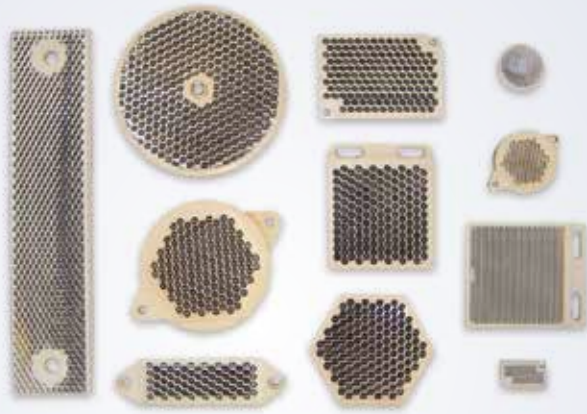

EXCELLENT PERFORMANCE WITH INFRARED, RED LIGHT AND POLARIZED EMISSION

- Prismatic reflectors for retroreflective sensors
- High efficiency models for long operating distances
- Microprism reflectors for sensors with LASER emission
- Self-adhesive reflectors and reflector tape

APPLICATIONS

- Automated warehousing
- Processing and Packaging machinery
- Industrial vehicles
- Automotive



REFLECTORS

Prismatic reflector material	Reflector in PMMA plastic
Support material	Support in ABS
Reflective tape	Polyester
Mechanical protection	IP67, IP69K (R4K)
Operating temperature	-30 ... +70°C

MODELS	DESCRIPTION	ORDER No.
R1	Ø 23 mm with Ø 31 mm support	S940700023
R2	Ø 48 mm with Ø 63 mm support	S940700048
R3	18 x 54 mm with 22 x 82 mm support	S940700972
R4	47x 47 mm with 51.5 x 61 mm support	95A151340
R4K	51X61 mm IP69K protection	95A151220
R5	Ø 75 mm with Ø 82 mm support	S940700075
R6	36 x 55 mm with 40.5 x 60 mm support	95A151350
R7	47x47 mm microprism reflector with 51 x 61 mm support	95A151360
R8	9.7 x 19 mm microprism reflector with 13.8 x 23 mm support	95A151370
R9	Ø 23 mm with Ø 25 mm self-adhesive support	95A151080
R10	36 x 176 mm with 41 x 181 mm support	S191200000
R11	146 x 15 mm with 150 x 18 mm support	95A155050
R12	R12 PRISMATIC REFLECTOR-100 X 100 mm	95A155060
R13	R13 PLASTIC REFLECTOR 20x32 mm	95A151300
R14	Ø 24 mm with Ø 25 mm support	95A151310
R15	REFLECTOR 60x19,2m M142-20	95A151290
R16	9.7 x 19 mm reflector with 14 x 23 mm support	95A151330
R20	Ø 48 mm microprism reflector with Ø 63 mm support	95A151090
R35	Ø 33 mm with Ø 35 mm support	95A151530
R100	19 x 35 mm reflector with 24 x 48 mm support	95ACC7990
RT3870	200 x 300 mm self-adhesive reflective tape	S940000600
RT3970	200 x 300 mm self-adhesive reflective tape for polarized light	S940000900
RT3970	60 x 40 mm self-adhesive reflective tape for polarized light	S940000604

DIMENSIONS

R1

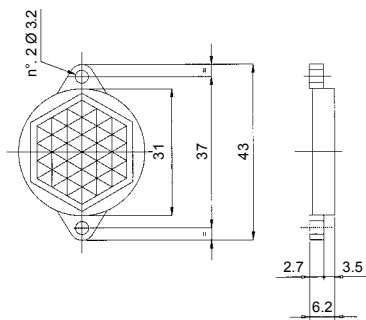

R2 / R20

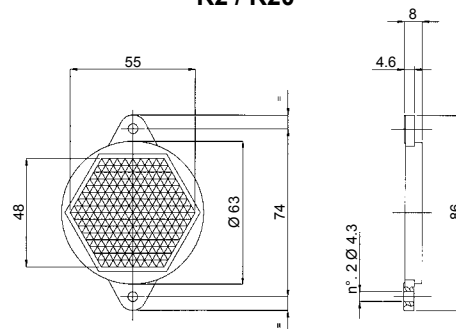

R3

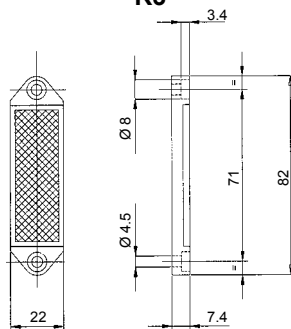

R4

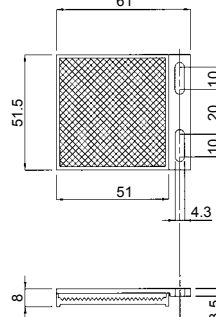

R5

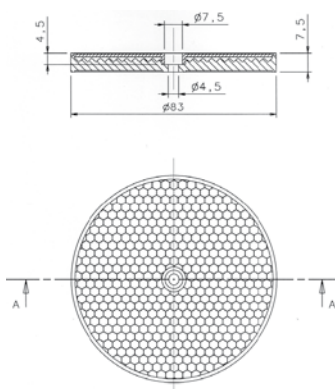

R6

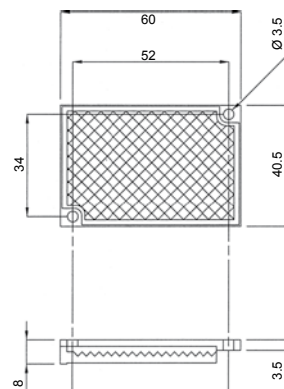

R7

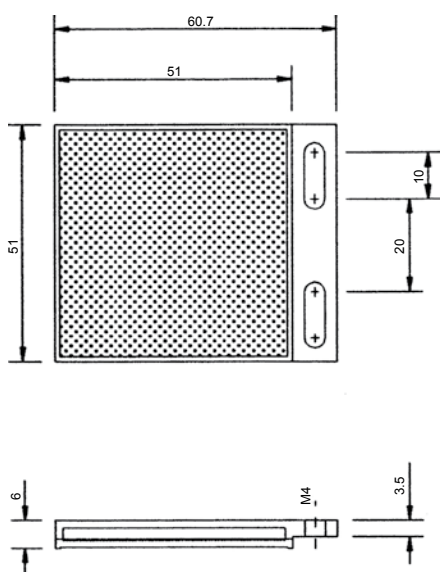

R8

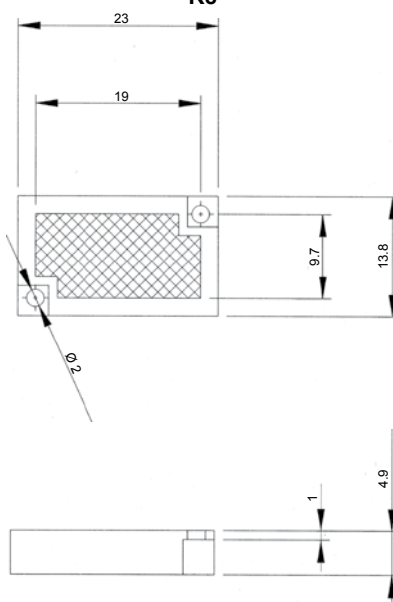

R9

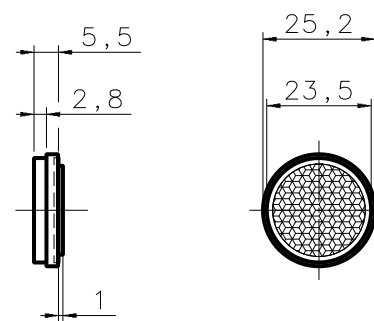

mm

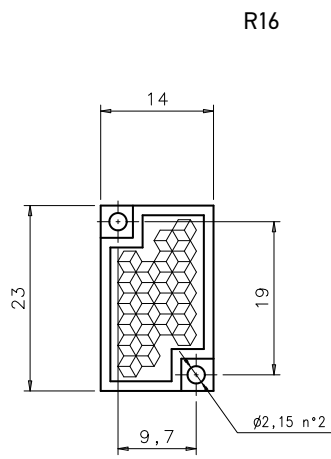
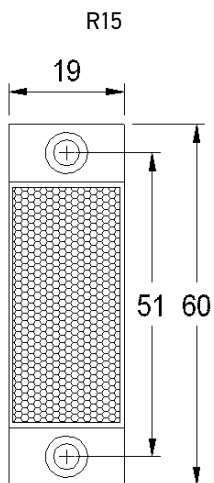
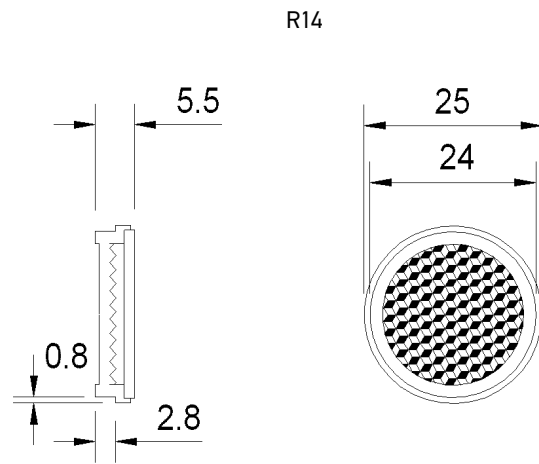
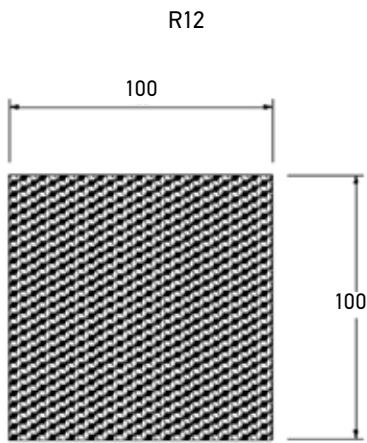
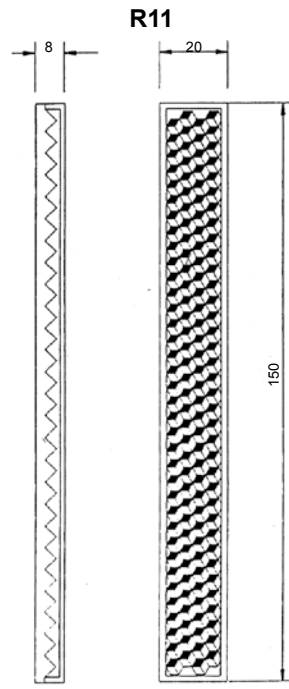
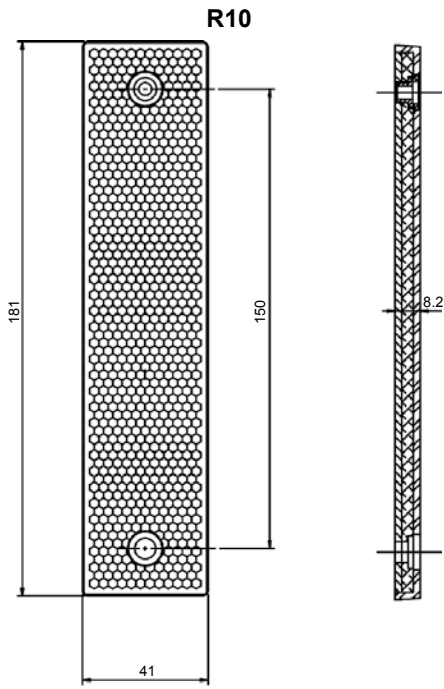

R35

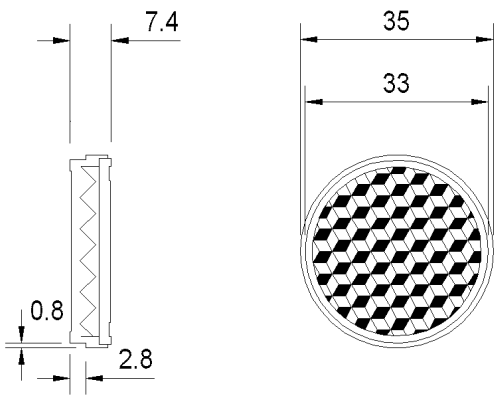

R100

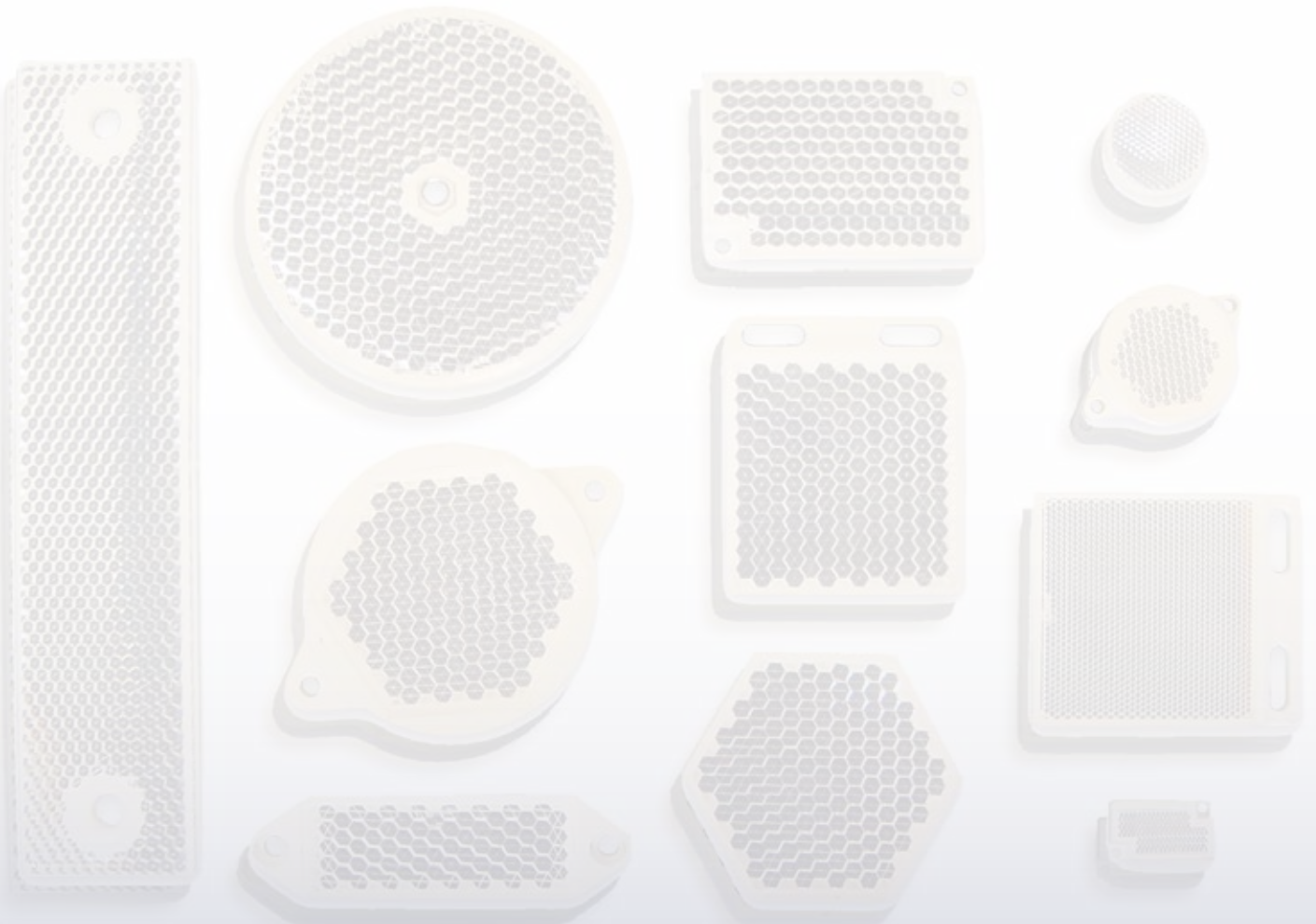
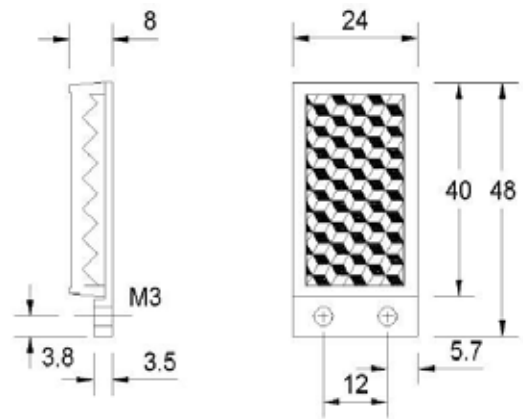

CS Series Cables & Connectors



THE RIGHT CONNECTION FOR YOUR PHOTOELECTRIC SENSORS FOR INDUSTRIAL ENVIRONMENT

- M8 and M12, axial or radial female connectors
- Standard length cables: 2, 3, 5, 7, 10, 15, 25 or 50m
- 3, 4, 5, 8 or 12 poles
- Shielded or unshielded models
- P.U.R. coated models for use in harsh environments
- P.V.C. coated models for standard use
- Standard M12 4 pole non-cabled connectors
- The cable jacket maybe marked 300V only as insulation voltage between wires, the operational voltage is 24Vdc or 10-30Vdc, less than 80 V required by CCC-China

CS	
Connectors	M8 axial or radial(90°) 3 poles M12 axial or radial(90°) 3 poles M8 axial or radial(90°) 4 poles M12 axial or radial(90°) 4 poles M12 axial 5 poles M12 axial 8 poles
Cable lengths	3, 5, 7, 10, 15, 25 m
Conductor diameter	42 x 0.10 mm - 0.35 mm≈ (m12 3-pole) 32 x 0.10 mm - 0.25 mm≈ (m12 4-pole) 32 x 0.10 mm - 0.25 mm≈ (m8 4-pole)
Conductor material	annealed non-tinned electrolytic copper
Flammability class	CEI 20-22, IEC 332/3
Housing material	flame-retardant and non-propagate P.U.R., P.V.C.
Mechanical protection	IP67, with locked ring

CONNECTOR & DIRECTION	POLES	STYLE	CABLE LENGTH	MODEL	ORDER No.	
M12 Connector (Axial)	3-pole	Grey, P.V.C.	3 m	CS-A1-01-G-03	95A251290	
			5 m	CS-A1-01-G-05	95A251300	
			7 m	CS-A1-01-G-07	95A251320	
			10 m	CS-A1-01-G-10	95A251340	
	4-pole	Grey, P.V.C.	3 m	CS-A1-02-G-03	95A251380	
			5 m	CS-A1-02-G-05	95A251270	
			7 m	CS-A1-02-G-07	95A251280	
			10 m	CS-A1-02-G-10	95A251390	
			P.U.R.	2 m	CS-A1-02-R-02	95A251540
				5 m	CS-A1-02-R-05	95A251560
	5-pole	Grey, P.V.C.	3 m	CS-A1-03-G-03	95ACC2110	
			5 m	CS-A1-03-G-05	95ACC2120	
			10 m	CS-A1-03-G-10	95ACC2140	
	8-pole	Black, P.V.C.	3 m	CS-A1-06-B-03	95ACC2230	
5 m			CS-A1-06-B-05	95ACC2240		
10 m			CS-A1-06-B-10	95ACC2250		
M12 Connector (Radial 90°)	3-pole	Grey, P.V.C.	3 m	CS-A2-01-G-03	95A251200	
			5 m	CS-A2-01-G-05	95A251210	
			7 m	CS-A2-01-G-07	95A251220	
			10 m	CS-A2-01-G-10	95A251230	
	4-pole	OIL resistant (CEI 2034-01)	3 m	CS-A2-01-O-03	95A251660	
			5 m	CS-A2-01-O-05	95A251670	
		Grey, P.V.C.	10 m	CS-A2-01-O-10	95A251680	
			3 m	CS-A2-02-G-03	95A251360	
			5 m	CS-A2-02-G-05	95A251240	
			7 m	CS-A2-02-G-07	95A251245	
			10 m	CS-A2-02-G-10	95A251260	
			P.U.R.	2 m	CS-A2-02-R-02	95A251550
				5 m	CS-A2-02-R-05	95A251570
			OIL resistant (CEI 2034-01)	5 m	CS-A2-02-O-05	95A251690
10 m	CS-A2-02-O-10	95A251700				

M12 Connector with LED (for PNP N.O. sensors) (Radial 90°)	3-pole	Grey, P.V.C.	5 m	CS-A2-11-G-05	95A251310	
			10 m	CS-A2-11-G-10	95A251330	
	4-pole	Grey, P.V.C.	3 m	CS-A2-12-G-03	95A251400	
			5 m	CS-A2-12-G-05	95A251350	
			10 m	CS-A2-12-G-10	95A251370	
			3 m	CS-B1-01-G-03	95A251490	
M8 Connector (Axial)	3-pole	Grey, P.V.C.	5 m	CS-B1-01-G-05	95A251510	
			2 m	CS-B1-01-R-02	95A251580	
		P.U.R.	5 m	CS-B1-01-R-05	95A251600	
			3 m	CS-B1-02-G-03	95A251420	
	4-pole	Grey, P.V.C.	5 m	CS-B1-02-G-05	95A251430	
			7 m	CS-B1-02-G-07	95A251440	
			10 m	CS-B1-02-G-10	95A251480	
			2 m	CS-B1-02-R-02	95A251620	
		P.U.R.	5 m	CS-B1-02-R-05	95A251640	
			5 m	CS-B1-02-O-05	95A251730	
			10 m	CS-B1-02-O-10	95A251100	
			3 m	CS-B2-01-G-03	95A251500	
M8 Connector (Radial 90°)	3-pole	Grey, P.V.C.	5 m	CS-B2-01-G-05	95A251520	
			2 m	CS-B2-01-R-02	95A251590	
		P.U.R.	5 m	CS-B2-01-R-05	95A251610	
			3 m	CS-B2-02-G-03	95A251450	
	4 pole	Grey, PVC	5 m	CS-B2-02-G-05	95A251460	
			7 m	CS-B2-02-G-07	95A251470	
			10 m	CS-B2-02-G-10	95A251530	
			2 m	CS-B2-02-R-02	95A251630	
		P.U.R.	5 m	CS-B2-02-R-05	95A251650	
			5 m	CS-B2-02-O-05	95A251720	
			10 m	CS-B2-02-O-10	95A251110	
			10 m	CV-A1-21-G-10	95ACC2060	
Shielded M12 Connector (Axial)	3-pole	Grey, P.V.C.	3 m	CV-A1-22-B-03	95ACC1480	
			5 m	CV-A1-22-B-05	95ACC1490	
			10 m	CV-A1-22-B-10	95ACC1500	
			15 m	CV-A1-22-B-15	95ACC2070	
	4-pole	Black, P.V.C.	25 m	CV-A1-22-B-25	95ACC2090	
			3 m	CV-A1-26-B-03	95ACC1510	
			5 m	CV-A1-26-B-05	95ACC1520	
			10 m	CV-A1-26-B-10	95ACC1530	
	8-pole	Black, P.V.C.	15 m	CV-A1-26-B-15	95ACC2080	
			25 m	CV-A1-26-B-25	95ACC2100	
			3 m	CV-A2-22-B-03	95ACC1540	
			5 m	CV-A2-22-B-05	95ACC1550	
Shielded M12 Connector (Radial 90°)	4-pole	Black, P.V.C.	10 m	CV-A2-22-B-10	95ACC1560	
			3 m	CV-A2-26-B-03	95ACC1600	
	8-pole	Black, P.V.C.	5 m	CV-A2-26-B-05	95ACC1610	
			10 m	CV-A2-26-B-10	95ACC1620	
M12 Connector (Axial)	4-pole	U.L., Black, P.V.C.	3 m	CS-A1-02-U-03	95ASE1120	
			5 m	CS-A1-02-U-05	95ASE1130	
			10 m	CS-A1-02-U-10	95ASE1140	
			15 m	CS-A1-02-U-15	95ASE1150	
			25 m	CS-A1-02-U-25	95ASE1160	
			3 m	CS-A1-03-U-03	95ASE1170	
	5-pole	U.L., Black, P.V.C.	5 m	CS-A1-03-U-05	95ASE1180	
			10 m	CS-A1-03-U-10	95ASE1190	
			15 m	CS-A1-03-U-15	95ASE1200	
			25 m	CS-A1-03-U-25	95ASE1210	
			50 m	CS-A1-03-U-50	95A252700	
			3 m	CS-A1-06-U-03	95ASE1220	
8-pole	U.L., Black, P.V.C.	5 m	CS-A1-06-U-05	95ASE1230		
		10 m	CS-A1-06-U-10	95ASE1240		
		15 m	CS-A1-06-U-15	95ASE1250		
		25 m	CS-A1-06-U-25	95ASE1260		
		50 m	CS-A1-06-U-50	95A252710		
		3 m	CS-A1-02-B-NC	G5085002		
M12 Connector (Axial)	4-pole	Black	Connector- not cabled	CS-A1-06-B-NC	95ACC2550	
8-pole	Black			Connector- not cabled	CS-A2-02-B-NC	G5085003
M12 Connector (Radial 90°)		4-pole	15 m		CS-A1-10-U-15	95A252750
		12-pole	50 m		CS-A1-10-U-50	95A252770
		12-pole	10 m		CS-A1-10-U-10	95A252740
M12 Connector (Axial)	12-pole	SG Extended blank rx	0,2 m	CS-G1-70-B-002	95A252830	
M12 Connector (Radial 90°)	12-pole	Black	3 m	CS-A1-10-U-03	95A252720	
M12 Connector (Axial)	5-pole	SG extended tx	0,2 m	CS-G1-50-B-002	95A252820	
SG Extended Cascade	---	SG extended cascade	0,05 m	CS-F1-80-B-0005	95A252860	
M12-SG Extended Muting RX	---	SG extended muting rx	0,2 m	CS-R1-75-B-002	95A252810	
M12-Slim Cascade	---	Slim cascade	0,1 m	CS-H1-03-B-001	95A252950	
M12 Connector (Axial)	8-pole	Shielded cable	3 m	CV-A1-36-B-03	95A255430	
	4-pole		5 m	CS-A1-03-G-03	95A252800	
Axial M12 Connector	5-pole, L coded power cable	Black 	3 m	CS-M1-02-B-03	95ACC0007	
Axial M12 F/M8 M Connector	4-pole, double headed		3 m	CS-H1-02-B-03	95ACC0008	
Axial M12 F/M12 M Connector	4-pole, double headed		3 m	CS-I1-02-B-03	95ACC0009	

COMPLEMENTARY SENSORS

Inductive proximity



IS

Non-contact detection
Cost effective and reliable detection of any metal part

Technical data

- Standard proximity M4, M5, M8, M12, M18, M30
- Double range (i.e. M12 4mm, M18 14mm, M30 20mm)
- Unshielded or shielded models for flush mounting
- Nickel brass or stainless steel short and long housing
- Ecolab and Diversey certifications for industrial detergents
- Multi-voltage, Metal face, Weld field immune models
- NO/NC, NPN or PNP output and programmable versions.

Applications

- Processing and Packaging machinery
- Assembling and conveyor lines
- Metal working and machine tools

Ultrasonic sensor



US

Distance measurement
Accurate positioning or distance control, immune to object color or light reflection

Technical data

- Square miniature or M18 background suppression with range 5 - 50cm and through beam up to 60cm
- M30 with range 0.2 - 2 m and min object 10mm
- M50 with range 0.2 - 8 m and min object 20mm
- Teach-in push-button and remote teach input
- NPN and PNP switching outputs for object detection
- 0-10 V or 4 - 20 mA analog out for distance measure
- High resolution to 1mm or 0.1% of distance range

Applications

- Packaging machinery
- Beverage and bottling plants
- Paper reel unwinding control

Fork sensors



SRX3

High resolution, fast response time
Execution of precise positioning, applying and printing of labels, even with any type/format of labels and bearer tapes, transparent on transparent and metallic ink

Technical data

- Dynamic or static teach models
- Slot size 3mm
- High resolution up to 2mm label gap
- M8 connector with PNP or NPN output
- M12 connector with PNP/NPN output and external teach-in
- Rugged and sturdy aluminium housing

Applications

- Detection of transparent, opaque labels, metallic ink label
- Double sheet detection
- Adhesive surface detection

Incremental encoders



ENC41/ENC58

Versatile and flexible incremental encoders with compact and standard dimensions. Hollow or solid shaft and universal output circuit

Technical data

- Plastic or aluminium housing Ø41mm and Ø58mm
- Hollow or solid shaft
- Resolution from 1 to 10000 PPR
- 1.5m cable connection
- ABO/ABO output signals
- Smart Push-Pull & Line-Drive output
- Power supply 5 - 30 Vdc

Applications

- Working and assembly lines
- Packaging machinery
- Light conveyors

Programmable incremental encoders



IEP58

Programmable incremental encoder reduces storage cost and downtime with to customer specific programming.

Technical data

- Standard housing Ø 58mm
- Resolution from 1 to 16384 PPR
- 1.5m cable connection
- ABO/ABO output signals
- Smart Push-Pull & Line-Drive output
- Power supply 5 - 30 Vdc

Applications

- Automated machinery
- Conveyor lines

Absolute encoders



AST58/AMT58

Compact optical single and multi-turn encoder
Extremely high accuracy
Serial interface SSI up to 25 bit
Modular fieldbus ProfiBus, Profinet; EtherCat, DeviceNet, CanOpen up to 30 bit.

Technical data

- Aluminium anticorodal metal case Ø58mm
- Solid shaft Ø6 or 10mm, hollow shaft Ø15mm
- M12, M23, or 1.5m cable connection
- Power supply 7.5 - 34 Vdc

Applications

- Motion control
- Automated machinery
- Length measurement/positioning

Please check www.datalogic.com for more information.



Rev. 10, 05/2020



9C514100E

Product and Company names and logos referenced may be either trademarks or registered trademarks of their respective companies. We reserve the right to make modifications and improvements.

www.datalogic.com