

MAIN FEATURES

Absolute linear system based on magnetic principle without wear thanks to no-contact technology. Thanks to high IP rating TMAA is suitable for harsh environment applications such as marble and glass working machines or washing systems machines.

- 5 µm max absolute resolution / 1 µm incremental resolution
- Power supply up to +30 V DC with SSI electrical interface
- Up to 5 m/s travel speed
- IP 67 as protection grade
- M12 radial connector
- To be used with BMAA magnetic tape



ORDERING CODE	TMAA	5	G	5/30	S	1	L	G	S	M12R	.162
SERIES magnetic absolute linear sensor	TMAA										
ABSOLUTE RESOLUTION 5 µm 10 µm	5	10									
CODE TYPE gray	G										
POWER SUPPLY 5 ... 30V DC	5/30										
ELECTRICAL ABSOLUTE INTERFACE Serial Synchronous Interface - SSI	S										
INCREMENTAL RESOLUTION without incremental signals 1 µm 5 µm 10 µm	X	1	5	10							
ELECTRICAL INCREMENTAL INTERFACE to be reported if not used RS-422	X	L									
MAX INCREMENTAL SIGNALS FREQUENCY to be reported if not used 1250 kHz 100 kHz 15 kHz refer to the table for travel speed limits	X	A	D	G							
ENCLOSURE RATING IP 67	S										
OUTPUT TYPE 12 pin M12 radial male connector	M12R										
MATING CONNECTOR mating connector not included for mating connector see Accessories	.162										

TMAA

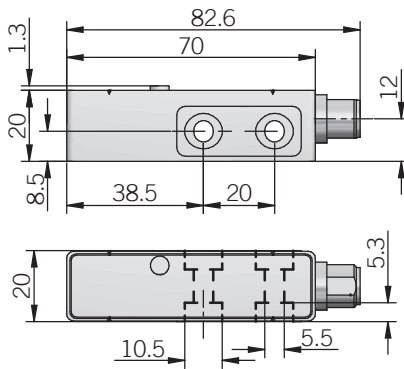

Mounting tolerances

Longitudinal tilt

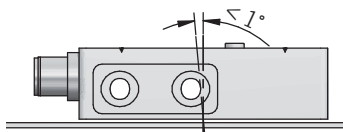

Lateral tilt

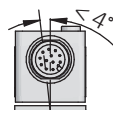

Alignment error

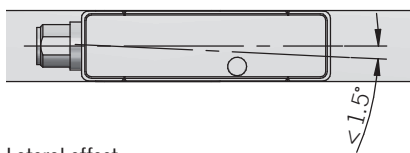

Lateral offset

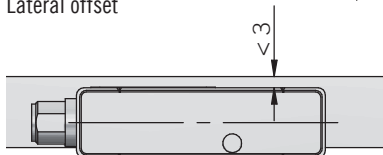

Airgap

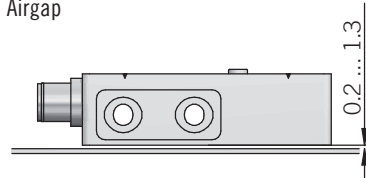

dimensions in mm

for connector please refer to Accessories

ELECTRICAL SPECIFICATIONS

Absolute resolution	5 - 10 μm
Incremental resolution	1 - 5 μm
Stroke	≤ 10240 mm
Power supply ¹	4,5 ... 30 V DC (reverse polarity protection)
Power draw without load	< 1,5 W
Electrical interface for absolute signals ²	RS-422
Electrical interface for incremental signals ²	RS-422
Clock frequency	50 ... 750 kHz
Pause time (Tc)	> 25 μs
SSI frame	(MSB ... LSB) 27 bit data length 24 bit data + 3 bit status
Code type	gray
Accuracy (sensor+tape)	± (0,02 + 0,03 x lenght) mm lenght in meter
Repeatability	± 5 μm, ± 1 increment
Max travel speed	≤ 5 m/s for absolute output refer to the table for incremental output
Electromagnetic compatibility	according to 2014/30/EU directive
RoHS	according to 2011/65/EU directive

MECHANICAL SPECIFICATIONS

Enclosure rating	IP 67 (IEC 60529)
Shock	50 G, 11 ms (IEC 60068-2-27)
Vibration	20 G, 10 ... 2000 Hz (IEC 60068-2-6)
Housing material	zinc die-cast
Operating temperature ^{3,4}	-30° ... +85°C (-22° ... +185°F)
Storage temperature ⁴	-40° ... +85°C (-40° ... +185°F)
Working distance from magnetic tape without steel cover tape	0,2 ... 1,3 mm
Weight	80 g (2,82 oz)

¹ as measured at the transducer without cable influences

² for further details refer to OUTPUT LEVELS on TECHNICAL BASICS section

³ measured on transducer housing

⁴ condensation allowed

INCREMENTAL FREQUENCY - TRAVEL SPEED

Resolution (μm)	Travel speed (m/s)		
	4	0,32	0,05
1	4	0,32	0,05
5	20	1,60	0,25
10	25	3,20	0,50
Max frequency (Khz)	1250	100	15,63

SSI INTERFACE

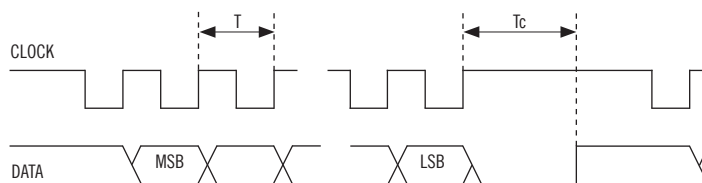

CLOCK Input from controller

T Clock signal period

Tc Pause time

CONNECTIONS

Function	M12 connector 12 pin
+ V DC	5
0 V	12
A+	7
A-	6
B+	9
B-	8
DATA +	2
DATA -	3
CLOCK +	11
CLOCK -	4
PROG	10



M12 connector (12 pin)

M12 A coded

solder side view FV