



FLAT AND BELLOWS ELLIPTICAL VACUUM CUPS WITH SUPPORTS

Complete range of flat elliptical vacuum cups, normally used for gripping, handling and clamping cardboard cases and boxes, wood shingles, small ceramic or brick tiles, iron or stainless steel profiles, sheets and anything else present on long, narrow gripping surfaces.

Instead, bellows elliptical vacuum cups, in addition to having the same function as the flat cups described above, are able to adapt to the gripping plane, even if not perfectly perpendicular to the axis of the vacuum cup, and can recover evident unevenness of the loads to be lifted.

They are normally available in the three standard compounds but can be supplied in special compounds listed on pg. 31 and in a minimum amount to be defined in the order, upon request.

Both items can be supplied with or without automation fastening support. Upon request, special non-rotating vacuum cup holders on which to assemble them are able to prevent their rotation during use.

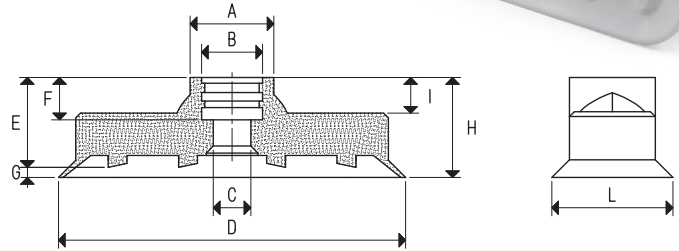
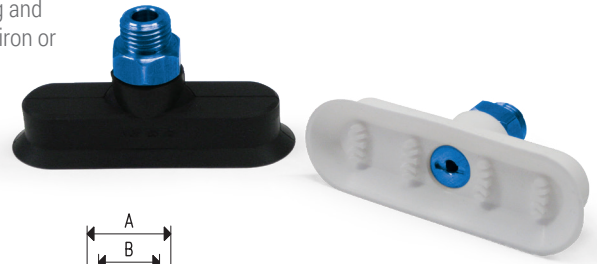

VACUUM CUPS

Item	Force Kg	A Ø	B Ø	C Ø	D	E	F	G	H	I	L	Volume cm ³
VOP 08 24 SR *	0.44	12.2	7.3	2.5	24	11.2	5.5	0.8	12.0	6.7	8.0	0.191
VOP 10 30 SR *	0.69	12.2	7.3	4.5	30	11.3	5.5	0.7	12.0	7.0	10.0	0.214
VOP 12 36 SR *	0.98	12.0	7.3	5.0	36	12.1	5.5	0.9	13.0	6.4	12.0	0.498
VOP 15 45 SR *	1.56	16.4	13.0	4.0	45	20.1	8.8	1.9	22.0	14.3	15.0	1.203
VOP 20 60 SR *	2.73	18.0	13.0	8.0	60	20.0	9.0	1.5	21.5	10.0	20.0	2.026
VOP 25 75 SR *	4.30	17.8	13.0	8.0	75	19.1	9.0	2.2	21.3	7.6	25.0	5.026
VOP 28 85 SR *	5.53	18.6	13.0	8.0	85	18.9	9.7	2.8	21.7	8.7	28.0	6.761
VOP 35 100 SR *	8.09	18.8	13.0	8.0	100	18.9	9.7	3.3	22.2	8.7	35.0	11.989

* Complete the code indicating the compound: A= oil-resistant rubber; N= natural para rubber; S= silicone

MALE SUPPORTS

Item	A Ø	B	D Ø	E	F	G	H	Support material	For vacuum cup item	Weight g
00 08 344	G1/8"	14	7.3	7	7	5.5	19.5	aluminium	VOP 08 24 SR VOP 10 30 SR VOP 12 36 SR	18.5
00 08 346	G1/4"	17	13.0	8	8	9.0	25.0	aluminium	VOP 15 45 SR	25.0
00 08 404	G1/4"	17	13.0	8	8	9.0	25.0	aluminium	VOP 20 60 SR VOP 25 75 SR	29.8
00 08 402	G1/4"	17	13.0	8	8	9.0	25.0	aluminium	VOP 28 85 SR VOP 35 100 SR	30.7

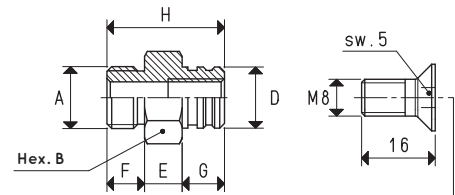

screw
item 00 08 347 for supp.00 08 402
item 00 08 348 for supp.00 08 404

Note: Supplied automatically also with the screw when ordering the item relative to the support

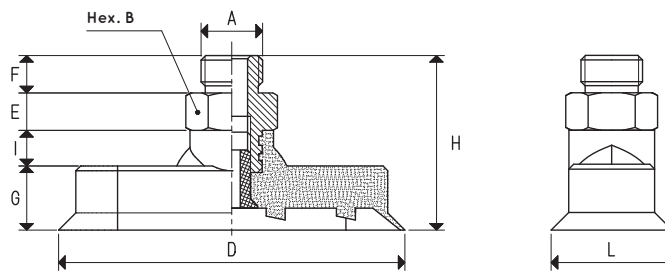

VACUUM CUPS WITH MALE SUPPORT

Item	Force Kg	A Ø	B	D	E	F	G	H	I	L	Vacuum cup item	Support item	Weight g
VOP 08 24 *	0.44	G1/8"	14	24	7	7	5.3	26.0	6.7	8.0	VOP 08 24 SR	00 08 344	19.7
VOP 10 30 *	0.69	G1/8"	14	30	7	7	5.0	26.0	7.0	10.0	VOP 10 30 SR	00 08 344	19.8
VOP 12 36 *	0.98	G1/8"	14	36	7	7	6.6	27.0	6.4	12.0	VOP 12 36 SR	00 08 344	20.6
VOP 15 45 *	1.56	G1/4"	17	45	8	8	7.7	38.0	14.3	15.0	VOP 15 45 SR	00 08 346	29.2
VOP 20 60 *	2.73	G1/4"	17	60	8	8	11.5	37.5	10.0	20.0	VOP 20 60 SR	00 08 404	38.3
VOP 25 75 *	4.30	G1/4"	17	75	8	8	13.7	37.3	7.6	25.0	VOP 25 75 SR	00 08 404	43.5
VOP 28 85 *	5.53	G1/4"	17	85	8	8	13.0	37.7	8.7	28.0	VOP 28 85 SR	00 08 402	50.7
VOP 35 100 *	8.09	G1/4"	17	100	8	8	13.5	38.2	8.7	35.0	VOP 35 100 SR	00 08 402	62.7

* Complete the code indicating the compound: A= oil-resistant rubber; N= natural para rubber; S= silicone

Note: The force of the vacuum cups indicated in the table represents 1/3 of the value of the theoretical force calculated at a level of vacuum of -75 KPa and a factor of safety 3.

Transformation ratio: N (newton) = Kg x 9.81 (force of gravity)

inch = $\frac{\text{mm}}{25.4}$; pounds = $\frac{\text{g}}{453.6} = \frac{\text{Kg}}{0.4536}$

Adapters for GAS - NPT threading available on page 1.130

ELLIPTICAL FLAT VACUUM CUPS WITH FEMALE SUPPORTS

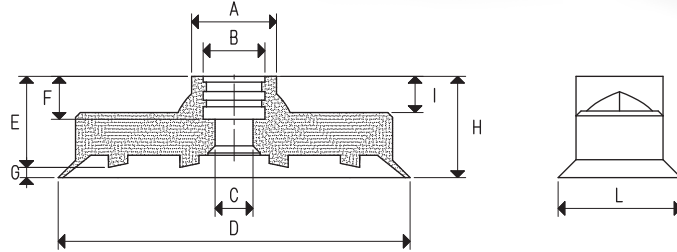
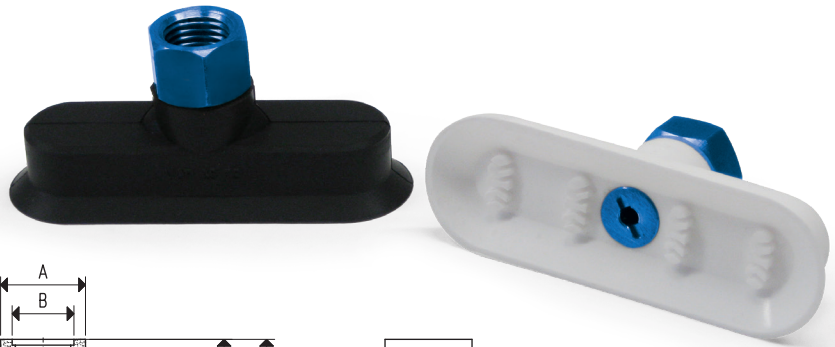

VACUUM CUPS

Item	Force Kg	A Ø	B Ø	C Ø	D	E	F	G	H	I	L	Volume cm ³
VOP 08 24 SR *	0.44	12.2	7.3	2.5	24	11.2	5.5	0.8	12.0	6.7	8.0	0.191
VOP 10 30 SR *	0.69	12.2	7.3	4.5	30	11.3	5.5	0.7	12.0	7.0	10.0	0.214
VOP 12 36 SR *	0.98	12.0	7.3	5.0	36	12.1	5.5	0.9	13.0	6.4	12.0	0.498
VOP 15 45 SR *	1.56	16.4	13.0	4.0	45	20.1	8.8	1.9	22.0	14.3	15.0	1.203
VOP 20 60 SR *	2.73	18.0	13.0	8.0	60	20.0	9.0	1.5	21.5	10.0	20.0	2.026
VOP 25 75 SR *	4.30	17.8	13.0	8.0	75	19.1	9.0	2.2	21.3	7.6	25.0	5.026
VOP 28 85 SR *	5.53	18.6	13.0	8.0	85	18.9	9.7	2.8	21.7	8.7	28.0	6.761
VOP 35 100 SR *	8.09	18.8	13.0	8.0	100	18.9	9.7	3.3	22.2	8.7	35.0	11.989

* Complete the code indicating the compound: A= oil-resistant rubber; N= natural para rubber; S= silicone

FEMALE SUPPORTS

Item	A Ø	B	D Ø	E	F	G	H	Support material	For vacuum cup item	Weight g
00 08 343	G1/8"	14	7.3	10	8.0	5.5	15.5	aluminium	VOP 08 24 SR VOP 10 30 SR VOP 12 36 SR	16.8
00 08 345	G1/4"	17	13.0	12	8.5	9.0	21.0	aluminium	VOP 15 45 SR	19.9
00 08 405	G1/4"	17	13.0	12	8.5	9.0	21.0	aluminium	VOP 20 60 SR VOP 25 75 SR	24.7
00 08 403	G1/4"	17	13.0	12	8.5	9.0	21.0	aluminium	VOP 28 85 SR VOP 35 100 SR	25.6

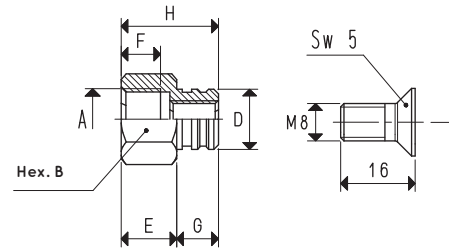

screw
item 00 08 347 for supp. 00 08 403
item 00 08 348 for supp. 00 08 405

Note: Supplied automatically also with the screw when ordering the item relative to the support

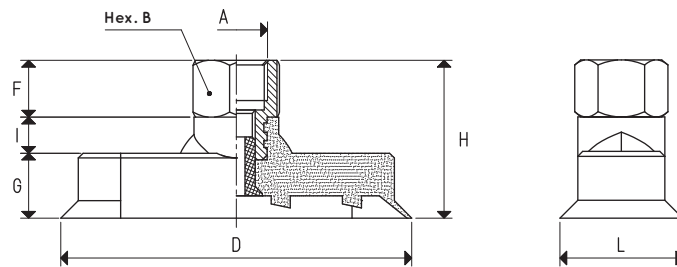

VACUUM CUPS WITH FEMALE SUPPORT

Item	Force Kg	A Ø	B	D	F	G	H	I	L	Vacuum cup item	Support item	Weight g
VOP 08 24 F *	0.44	G1/8"	14	24	10	5.3	22.0	6.7	8.0	VOP 08 24 SR	00 08 343	18.0
VOP 10 30 F *	0.69	G1/8"	14	30	10	5.0	22.0	7.0	10.0	VOP 10 30 SR	00 08 343	18.1
VOP 12 36 F *	0.98	G1/8"	14	36	10	6.6	23.0	6.4	12.0	VOP 12 36 SR	00 08 343	18.9
VOP 15 45 F *	1.56	G1/4"	17	45	12	7.7	24.0	14.3	15.0	VOP 15 45 SR	00 08 345	23.9
VOP 20 60 F *	2.73	G1/4"	17	60	12	11.5	33.5	10.0	20.0	VOP 20 60 SR	00 08 405	33.2
VOP 25 75 F *	4.30	G1/4"	17	75	12	13.7	33.3	7.6	25.0	VOP 25 75 SR	00 08 405	38.4
VOP 28 85 F *	5.53	G1/4"	17	85	12	13.0	33.7	8.7	28.0	VOP 28 85 SR	00 08 403	45.6
VOP 35 100 F *	8.09	G1/4"	17	100	12	13.5	34.2	8.7	35.0	VOP 35 100 SR	00 08 403	57.6

* Complete the code indicating the compound: A= oil-resistant rubber; N= natural para rubber; S= silicone

Note: The force of the vacuum cups indicated in the table represents 1/3 of the value of the theoretical force calculated at a level of vacuum of -75 KPa and a factor of safety 3.

Transformation ratio: N (newton) = Kg x 9.81 (force of gravity)

inch = $\frac{\text{mm}}{25.4}$; pounds = $\frac{\text{g}}{453.6} = \frac{\text{Kg}}{0.4536}$

Adapters for GAS - NPT threading available on page 1.130



ELLIPTICAL BELLOWS VACUUM CUPS WITH MALE SUPPORTS

3D drawings are available on vuototecnica.net

1

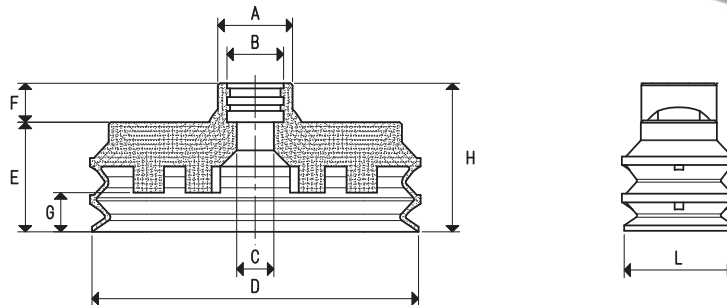

VACUUM CUPS

Item	Force Kg	A Ø	B Ø	C Ø	D	E	F	G bellows stroke	H	L	Volume cm ³
VOS 08 25 *	0.51	10.0	7.3	1.3	25.0	12.4	6.0	3.0	18.4	8.0	0.852
VOS 15 45 *	1.56	17.2	13.0	4.0	45.0	18.6	10.0	6.5	28.6	15.0	4.978
VOS 25 75 *	4.30	17.2	13.0	9.0	75.0	25.2	9.0	8.5	34.2	25.0	23.083

* Complete the code indicating the compound: A= oil-resistant rubber; N= natural para rubber; S= silicone

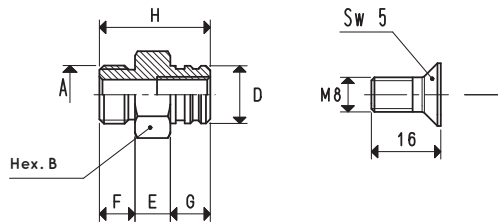

screw
item **00 08 347** for supp. **00 08 402**

Note: Supplied automatically also with the screw when ordering the item relative to the support

MALE SUPPORTS

Item	A Ø	B	D Ø	E	F	G	H	Support material	For vacuum cup item	Weight g
00 08 344	G1/8"	14	7.3	7	7	5.5	19.5	aluminium	VOS 08 25	18.5
00 08 346	G1/4"	17	13.0	8	8	9.0	25.0	aluminium	VOS 15 45	25.0
00 08 402	G1/4"	17	13.0	8	8	9.0	25.0	aluminium	VOS 25 75	30.7

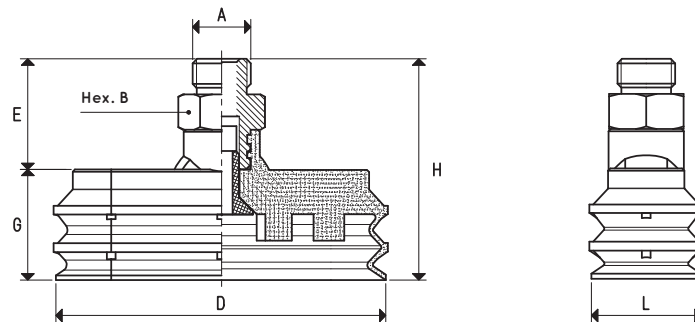

VACUUM CUPS WITH MALE SUPPORT

Item	Force Kg	A Ø	B	D	E	G	H	L	Vacuum cup item	Support item	Weight g
VOS 08 25 M *	0.51	G1/8"	14	25.0	20.0	12.4	32.4	8.0	VOS 08 25	00 08 344	20.0
VOS 15 45 M *	1.56	G1/4"	17	45.0	26.0	18.6	44.6	15.0	VOS 15 45	00 08 346	31.4
VOS 25 75 M *	4.30	G1/4"	17	75.0	25.0	25.2	50.2	25.0	VOS 25 75	00 08 402	47.3

* Complete the code indicating the compound: A= oil-resistant rubber; N= natural para rubber; S= silicone

Note: The force of the vacuum cups indicated in the table represents 1/3 of the value of the theoretical force calculated at a level of vacuum of -75 KPa and a factor of safety 3.

Transformation ratio: N (newton) = Kg x 9.81 (force of gravity)

inch = $\frac{\text{mm}}{25.4}$; pounds = $\frac{\text{g}}{453.6} = \frac{\text{Kg}}{0.4536}$

Adapters for GAS - NPT threading available on page 1.130

ELLIPTICAL BELLOWS VACUUM CUPS WITH FEMALE SUPPORTS

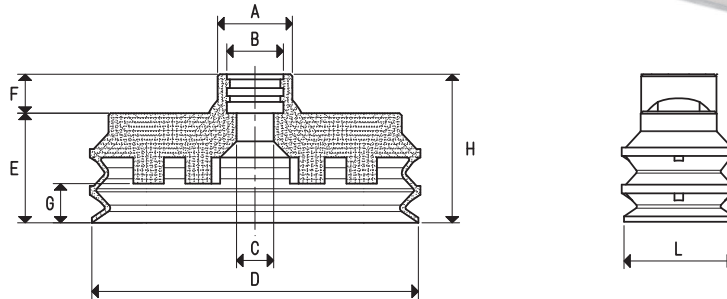

VACUUM CUPS

Item	Force Kg	A Ø	B Ø	C Ø	D	E	F	G bellows stroke	H	L	Volume cm ³
VOS 08 25 *	0.51	10.0	7.3	1.3	25.0	12.4	6.0	3.0	18.4	8.0	0.852
VOS 15 45 *	1.56	17.2	13.0	4.0	45.0	18.6	10.0	6.5	28.6	15.0	4.978
VOS 25 75 *	4.30	17.2	13.0	9.0	75.0	25.2	9.0	8.5	34.2	25.0	23.083

* Complete the code indicating the compound: A= oil-resistant rubber; N= natural para rubber; S= silicone

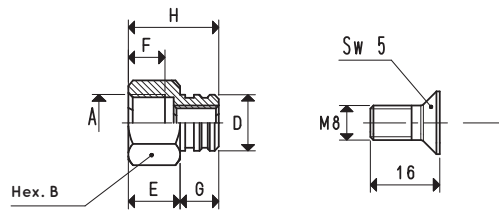

screw
item 00 08 347 for supp.00 08 403

Note: Supplied automatically also with the screw when ordering the item relative to the support

FEMALE SUPPORTS

Item	A Ø	B Ø	D Ø	E	F	G	H	Support material	For vacuum cup item	Weight g
00 08 343	G1/8"	14	7.3	10	8.0	5.5	15.5	aluminium	VOS 08 25	16.8
00 08 345	G1/4"	17	13.0	12	8.5	9.0	21.0	aluminium	VOS 15 45	19.9
00 08 403	G1/4"	17	13.0	12	8.5	9.0	21.0	aluminium	VOS 25 75	25.6

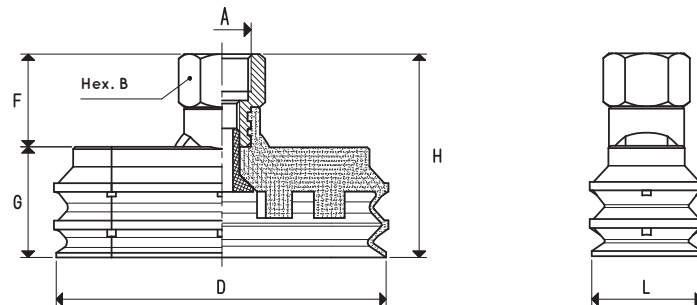

VACUUM CUPS WITH FEMALE SUPPORT

Item	Force Kg	A Ø	B Ø	D	F	G	H	L	Vacuum cup item	Support item	Weight g
VOS 08 25 F *	0.51	G1/8"	14	25.0	16.0	12.4	28.4	8.0	VOS 08 25	00 08 343	18.3
VOS 15 45 F *	1.56	G1/4"	17	45.0	22.0	18.6	40.6	15.0	VOS 15 45	00 08 345	26.3
VOS 25 75 F *	4.30	G1/4"	17	75.0	21.0	25.2	46.2	25.0	VOS 25 75	00 08 403	42.2

* Complete the code indicating the compound: A= oil-resistant rubber; N= natural para rubber; S= silicone

Note: The force of the vacuum cups indicated in the table represents 1/3 of the value of the theoretical force calculated at a level of vacuum of -75 KPa and a factor of safety 3.

Transformation ratio: N (newton) = Kg x 9.81 (force of gravity) inch = $\frac{\text{mm}}{25.4}$; pounds = $\frac{\text{g}}{453.6} = \frac{\text{Kg}}{0.4536}$ Adapters for GAS - NPT threading available on page 1.130